



*Personal Computer
Hardware Reference
Library*

IBM Graphics Printer

IBM Graphics Printer

6361480



Contents

Description	1
Programming Considerations	3
Printer Control Codes	3
Printer Control Code Quick Reference	13
Print Mode Combinations	16
Graphics Printer Character Set	17
DIP-Switch Settings	22
Interface	25
Specifications	27
Connector Pin Assignments	29
Logic Diagrams	33



Description

The IBM Graphics Printer is a self-powered, stand-alone, tabletop unit. It prints in two directions at 80 characters per second (cps).

A 9-wire print head is used to print characters in a 9-by-9 dot matrix. The IBM Graphics Printer can print in a compressed mode of 132 characters per line, in a standard mode of 80 characters per line, in a double-width compressed mode of 66 characters per line, and in a double-width mode of 40 characters per line. The printer can print double-size characters and double-strike characters.

Besides printing the standard ASCII 96-character uppercase and lowercase character sets, the IBM Graphics Printer has additional capabilities including: an extended character set for international languages, subscript, superscript, an underline mode, and programmable graphics. It can also accept commands setting the line-feed control desired for the application.

The printer unit obtains ac power from a standard 120-Vac wall outlet. A 220-Vac model and a 240-Vac model are also available. A 1.83 m (6 ft) signal cable connects the printer to the system unit's Printer Adapter or combination Monochrome Display and Printer Adapter. The cable is a 25-lead shielded cable with a 25-pin D-shell connector at the system unit end, and a 36-pin connector at the printer end.



Programming Considerations

Printer Control Codes

On the following pages you will find codes for printer characters, controls, and graphics. You may want to keep them handy for future reference. The examples given in the “Printer Function” descriptions are written in the BASIC language. The “Input” description is given when more information is needed for programming considerations.

ASCII decimal values for the printer control codes can be found under “Graphics Printer Character Set.”

The descriptions that follow assume that the printer dual-in-line package (DIP) switches have not been changed from their factory settings.

Printer Code	Printer Function
BEL	<p>Bell Sounds the printer buzzer for 1 second. Example: LPRINT CHR\$(7);</p>
CAN	<p>Cancel Clears the printer buffer. Control codes, except SO, remain in effect. Example: LPRINT CHR\$(24);</p>
CR	<p>Carriage Return Ends the line that the printer is on and prints the data remaining in the printer buffer. (No Line Feed operation takes place.)</p> <p>Note: IBM Personal Computer BASIC adds a Line Feed unless CHR\$(128) is added; for example, CHR\$(141).</p> <p>Example: LPRINT CHR\$(13);</p>
DC2	<p>Device Control 2 (Compressed Off) Cancels the Compressed print mode. Example: LPRINT CHR\$(18);</p>
DC4	<p>Device Control 4 (Double Width Off) Cancels the Double Width print mode. Example: LPRINT CHR\$(20);</p>
ESC	<p>Escape Signals the printer that the next data sent is a printer command. Example: LPRINT CHR\$(27);</p>

Printer Code	Printer Function
ESC A	<p>Escape A (Sets Variable Line Feeding) Format: ESC A;n; Escape A sets the line-feed to n/72 inch. The example that follows sets line feeding to 24/72 inch. ESC 2 must be sent to the printer before the line feeding will change. For example, ESC A;24 (text) ESC 2 (text). The text following ESC A;24 will be at the previously set line-feed increment. The text following ESC 2 will be printed with the new line-feed increment of 24/72 inch. Any increment between 1/72 and 85/72 may be used. Example: LPRINT CHR\$(27);CHR\$(65);CHR\$(24); CHR\$(27);CHR\$(50);</p> <p>Note: How to enter "n": When "n" is actually transferred to the printer as data, it is transferred in the form of a 7-bit binary number. In the case of "ESC A+24," actual output to the printer is performed as <1B>H<41>H<18>H in hexadecimal code.</p>
ESC C	<p>Escape C (Set Lines per Page) Format:ESC C;n; Sets the page length. ESC C command must be followed by a value to specify the length of page desired. (Maximum form length for the printer is 127 lines.) The example below sets the page length to 55 lines. The printer defaults to 66 lines per page when powered on or reset. Example: LPRINT CHR\$(27);CHR\$(67); CHR\$(55);</p> <p>Escape C (Set Inches per Page) Format:ESC C;n;m; Escape C sets the length of the page in inches (one inch is 25.4 millimeters). This command requires a value of 0 (zero) for n, and a value between 1 and 22 for m. Example: LPRINT CHR\$(27);CHR\$(67);CHR\$(0); CHR\$(12);</p>
ESC D	<p>Escape D (Set Horizontal Tab Stops) Format: ESC D;n₁;n₂;...n_k;NUL; Sets the horizontal tab stop positions. The example that follows sets the horizontal tab stop positions at printer columns 10, 20, and 40. They are followed by CHR\$(0), the Null code. They must be given in ascending numeric order. Tab stops can be set between 1 and 80. When the printer is in the Compressed print mode, tab stops can be set up to 132. The Graphics Printer can have a maximum of 28 tab stops. The HT Code (CHR\$(9)) is used to execute a tab operation. Example: LPRINT CHR\$(27);CHR\$(68);CHR\$(10); CHR\$(20);CHR\$(40);CHR\$(0);</p>

Printer Code	Printer Function
ESC E	<p>Escape E (Emphasized) Sets the printer to the Emphasized print mode. The speed of the printer is reduced to half speed during the Emphasized print mode. Example: LPRINT CHR\$(27);CHR\$(69);</p>
ESC F	<p>Escape F (Emphasized Off) Cancels the Emphasized print mode. Example: LPRINT CHR\$(27);CHR\$(70);</p>
ESC G	<p>Escape G (Double Strike) Sets the printer to the Double Strike print mode. The paper is spaced 1/216 inch before the second pass of the print head. Example: LPRINT CHR\$(27);CHR\$(71);</p>
ESC H	<p>Escape H (Double Strike Off) Cancels the Double Strike mode. Example: LPRINT CHR\$(27);CHR\$(72);</p>
ESC J	<p>Escape J (Sets Variable Line Feeding) Format: ESC J;n; When ESC J is sent to the printer, the paper will advance in increments of n/216 inch. The value of n must be between 1 and 255. The example that follows sets the line feed to 50/216 inch. ESC J is canceled after the line feed takes place. Example: LPRINT CHR\$(27);CHR\$(74);CHR\$(50);</p>

Printer Code	Printer Function																	
ESC K	<p>Escape K (480 Bit-Image Graphics Mode) Format ESC K; n_1; n_2; v_1; v_2; ... v_k; Changes from the Text mode to the 480 Bit-Image Graphics mode. n_1 and n_2 are one byte each, and together specify the number of bit-image data bytes (k) to be transferred. v_1 through v_k are the bytes of the bit-image data. The number of bit-image data bytes (k) is equal to $n_1 + 256n_2$ and cannot exceed 480 bytes. At every horizontal position, each byte can print up to 8 vertical dots. The least significant bit of the byte corresponds to the bottom dot; the most significant bit of the byte corresponds to the top dot. Bit-image data may be mixed with text data on the same line.</p> <p>Note: Assign values to n_1 and n_2 as follows: n_1 represents values from 0 through 255. n_2 represents the values of either 0 or 1 with a weight of 256.</p> <p>The (z)s in the following description of n_1 and n_2 can be either 1's or 0's.</p> <div style="text-align: center; margin: 20px 0;"> n_2 <table border="1" style="margin: 0 auto; border-collapse: collapse;"> <tr> <td style="padding: 5px 10px;">0</td> <td style="padding: 5px 10px;">0</td> <td style="padding: 5px 10px;">0</td> <td style="padding: 5px 10px;">0</td> <td style="padding: 5px 10px;">0</td> <td style="padding: 5px 10px;">0</td> <td style="padding: 5px 10px;">0</td> <td style="padding: 5px 10px;">0</td> <td style="padding: 5px 10px;">z</td> </tr> </table> <p style="margin: 5px 0;">2^{15} 2^{14} 2^{13} 2^{12} 2^{11} 2^{10} 2^9 2^8</p> </div> <div style="text-align: center; margin: 20px 0;"> n_1 <table border="1" style="margin: 0 auto; border-collapse: collapse;"> <tr> <td style="padding: 5px 10px;">z</td> <td style="padding: 5px 10px;">z</td> <td style="padding: 5px 10px;">z</td> <td style="padding: 5px 10px;">z</td> <td style="padding: 5px 10px;">z</td> <td style="padding: 5px 10px;">z</td> <td style="padding: 5px 10px;">z</td> <td style="padding: 5px 10px;">z</td> </tr> </table> <p style="margin: 5px 0;">2^7 2^6 2^5 2^4 2^3 2^2 2^1 2^0</p> </div>	0	0	0	0	0	0	0	0	z	z	z	z	z	z	z	z	z
0	0	0	0	0	0	0	0	z										
z	z	z	z	z	z	z	z											

Printer Code	Printer Function																																				
ESC K Cont.	<p>Data sent to the printer.</p> <table border="1" data-bbox="247 207 905 456"> <thead> <tr> <th>Data A</th> <th>ESC</th> <th>K</th> <th>n_1</th> <th>n_2</th> <th>Data B</th> <th>Data C</th> <th>ESC</th> <th>K</th> <th>n_1</th> <th>n_2</th> <th>Data D</th> </tr> </thead> <tbody> <tr> <td>Text Data</td> <td></td> <td></td> <td>Length of bit image data</td> <td></td> <td>Bit-image data</td> <td>Text data</td> <td></td> <td></td> <td>Length of bit image data</td> <td></td> <td>Bit-image data</td> </tr> <tr> <td></td> <td></td> <td></td> <td></td> <td></td> <td>$v_1 - v_k$</td> <td></td> <td></td> <td></td> <td></td> <td></td> <td>$v_1 - v_k$</td> </tr> </tbody> </table> <p style="text-align: center;">← 480 bit-image positions →</p> <p>Note: Assume a total of 20 characters of text data (data A and data C). In Text mode, 20 characters correspond to 120 bit-image positions ($20 \times 6 = 120$). The printable portion left for Bit-Image Graphics data (data B and data D) is 360 bit-image positions ($480 - 120 = 360$).</p> <p>Example:</p> <pre> 1 'OPEN PRINTER IN RANDOM MODE WITH LENGTH OF 255 2 WIDTH "LPT1:",255 3 OPEN "LPT1:" AS #1 4 PRINT #1,CHR\$(13);CHR\$(10); 5 SLASH\$=CHR\$(1)+CHR\$(02)+ CHR\$(04)+CHR\$(08) 6 SLASH\$=SLASH\$+CHR\$(16)+CHR\$(32)+ CHR\$(64)+CHR\$(128)+CHR\$(0) 7 GAP\$=CHR\$(0)+CHR\$(0)+CHR\$(0) 8 NDOTS=480 9 'ESC K N1 N2 10 PRINT #1,CHR\$(27);"K";CHR\$(NDOTS MOD 256); CHR\$(FIX (NDOTS/256)); 11 'SEND NDOTS NUMBER OF BIT IMAGE BYTES 12 FOR I=1 TO NDOTS/12 'NUMBER OF SLASHES TO PRINT USING GRAPHICS 13 PRINT #1,SLASH\$;GAP\$; 14 NEXT I 15 CLOSE 16 END </pre> <p>This example will give you a row of slashes printed in the Bit-Image Graphics mode.</p>	Data A	ESC	K	n_1	n_2	Data B	Data C	ESC	K	n_1	n_2	Data D	Text Data			Length of bit image data		Bit-image data	Text data			Length of bit image data		Bit-image data						$v_1 - v_k$						$v_1 - v_k$
Data A	ESC	K	n_1	n_2	Data B	Data C	ESC	K	n_1	n_2	Data D																										
Text Data			Length of bit image data		Bit-image data	Text data			Length of bit image data		Bit-image data																										
					$v_1 - v_k$						$v_1 - v_k$																										

Printer Code	Printer Function
ESC L	<p>Escape L (960 Bit-Image Graphics Mode) Format: ESC L;n_1;n_2;v_1;v_2;...;v_k; Changes from the Text mode to the 960 Bit-Image Graphics mode. The input is similar to ESC K. The 960 Bit-Image Graphics mode prints at half the speed of the 480 Bit-Image Graphics mode, but can produce a denser graphic image. The number of bytes of bit-image data (k) is $n_1 + 256n_2$ but cannot exceed 960. n_1 is in the range of 0 to 255.</p>
ESC N	<p>Escape N (Set Skip Perforation) Format ESC N;n; Sets the Skip Perforation function. The number following ESC N sets the value for the number of lines of Skip Perforation. The example shows a 12-line skip. This will print 54 lines and advance the paper 12 lines. The value of n must be between 1 and 127. ESC N must be reset anytime the page length (ESC C) is changed. Example: LPRINT CHR\$(27);CHR\$(78);CHR\$(12);</p>
ESC O	<p>Escape O (Cancel Skip Perforation) Cancels the Skip Perforation function. Example: LPRINT CHR\$(27);CHR\$(79);</p>
ESC S	<p>Escape S (Subscript/Superscript) Format: ESC S;n; Sets the printer to the Subscript print mode when ESC S is followed by a 1, as in the example that follows. When ESC S is followed by a 0 (zero), the printer will print in the Superscript print mode. Example: LPRINT CHR\$(27);CHR\$(83);CHR\$(1);</p>
ESC T	<p>Escape T (Subscript/Superscript Off) Cancels printing in the Subscript or Superscript print mode. Example: LPRINT CHR\$(27);CHR\$(84);</p>
ESC U	<p>Escape U (Unidirectional Printing) Format: ESC U;n; The printer will print from left to right when ESC U is followed by a 1. When ESC U is followed by a 0 (zero), the left to right printing operation is canceled. The unidirectional printing (ESC U) ensures a more accurate print-start position for better print quality. Example: LPRINT CHR\$(27);CHR\$(85);CHR\$(1);</p>

Printer Code	Printer Function
ESC W	<p>Escape W (Double Width) Format: ESC W;n; Sets the printer to the Double Width print mode when ESC W is followed by a 1. This mode must be canceled with ESC W followed by a 0 (zero) Example: LPRINT CHR\$(27);CHR\$(87);CHR\$(1);</p>
ESC Y	<p>Escape Y (960 Bit-Image Graphics Mode Normal Speed) Format: ESC Y n₁;n₂;v₁;v₂;...v_k; Changes from the Text mode to the 960 Bit-Image Graphics mode, at normal speed. The printer cannot print dots on consecutive dot positions. The input of data is similar to ESC L.</p>
ESC Z	<p>Escape Z (1920 Bit-Image Graphics Mode) Format: ESC Z;n₁;n₂;v₁;v₂;...v_k; Changes from the Text mode to the 1920 Bit-Image Graphics mode. The input is similar to the other Bit-Image Graphics modes. ESC Z can print only every third dot position.</p>
ESC 0	<p>Escape 0 (1/8-Inch Line Feeding) Sets paper feeding to 3.175 mm (1/8 in.). Example: LPRINT CHR\$(27);CHR\$(48);</p>
ESC 1	<p>Escape 1 (7/72-Inch Line Feeding) Sets paper feeding to 2.47 mm (7/72 in.). Example: LPRINT CHR\$(27);CHR\$(49);</p>
ESC 2	<p>Escape 2 (Start Variable Line Feeding) ESC 2 is an execution command for ESC A. If no ESC A command is given, line feeding returns to 4.23mm (1/6 in.). Example: LPRINT CHR\$(27);CHR\$(50);</p>
ESC 3	<p>Escape 3 (Variable Line Feeding) Format: ESC 3;n; Changes the paper feeding to n/216 inch. The example that follows sets the paper feeding to 1/4 inch The value of n must be between 1 and 255. Example: LPRINT CHR\$(27);CHR\$(51);CHR\$(54);</p>
ESC 6	<p>Escape 6 (Select Character Set 2) Selects Character Set 2. (See "Graphics Printer Character Set 2" later in this section.) Example: LPRINT CHR\$(27);CHR\$(54);</p>

Printer Code	Printer Function
ESC 7	<p>Escape 7 (Select Character Set 1) Selects character set 1. (See "Graphics Printer Character Set 1" later in this section.) Character set 1 is automatically selected when the printer is set to on or reset. Example: LPRINT CHR\$(27);CHR\$(55);</p>
ESC 8	<p>Escape 8 (Ignore Paper End) Allows the printer to print to the end of the paper. The printer ignores the Paper End switch. Example: LPRINT CHR\$(27);CHR\$(56);</p>
ESC 9	<p>Escape 9 (Cancel Ignore Paper End) Cancels the Ignore Paper End command. ESC 9 is automatically selected when the printer is set to on or reset. Example: LPRINT CHR\$(27);CHR\$(57);</p>
ESC -	<p>Escape Minus (Underline) Format: ESC -;n; ESC - followed by a 1, prints all of the following data with an underline. ESC - followed by a 0 (zero), cancels the Underline print mode. Example: LPRINT CHR\$(27);CHR\$(45);CHR\$(1);</p>
ESC <	<p>Escape Less Than (Home Head) The print head will return to the left margin to print one line following ESC <. Example: LPRINT CHR\$(27);CHR\$(60);</p>
FF	<p>Form Feed Advances the paper to the top of the next page.</p> <p>Note: The location of the paper when the printer is set to on, determines the top of the page. The next top of page is 279.4 mm (11 in.) from that position. ESC C can be used to change the page length.</p> <p>Example: LPRINT CHR\$(12);</p>
HT	<p>Horizontal Tab Tabs to the next horizontal tab stop. Tab stops are set every 8 columns when the printer's power is applied and can be changed with ESC D. Example: LPRINT CHR\$(9);</p>

Printer Code	Printer Function
LF	<p>Line Feed Advances the paper up one line. Line spacing is 4.23 mm (1/6 in.) unless reset by ESC A, ESC 0, ESC 1, ESC 2 or ESC 3. Example: LPRINT CHR\$(10);</p>
NUL	<p>Null Used with ESC B and ESC D as a list terminator. NUL also is used with other printer control codes to select options (for example, ESC S). Example: LPRINT CHR\$(0);</p>
SI	<p>Shift In (Compressed) Changes the printer to the Compressed print mode. Example: LPRINT CHR\$(15);</p>
SO	<p>Shift Out (Double Width) Changes the printer to the Double Width print mode.</p>

Printer Control Code Quick Reference

This is an alphabetic listing of the descriptions of the printer control codes. You will find it helpful to locate the code you need to perform a certain job, or determine the ASCII decimal value quickly, once you are familiar with the control codes.

Note: ASCII values greater than 27 must be preceded by the ESC code (ASCII value 27).

Description	Code	ASCII Value
Alarm	BEL	7
Audible alarm	BEL	7
Bell	BEL	7
Buzzer	BEL	7
Cancel	CAN	24
Cancel data	CAN	24
Cancel double-strike printing	ESC H	72
Cancel double-width by line	DC4	20
Cancel double-width (lines)	ESC W	87
Cancel emphasized printing	ESC F	70
Cancel ignore paper end	ESC 9	57
Cancel perforation skip	ESC O	79
Cancel subscript/superscript	ESC T	84
Carriage return	CR	13
Character set 1 select	ESC 7	55
Character set 2 select	ESC 6	54
Character spacing 10 per inch	DC2	18
Character spacing 17.1 per inch	SI	15
Clear printer buffer	CAN	24
Command designator	ESC	27
Command end	NUL	0
Command prefix	ESC	27
Command start	ESC	27
Command terminator	NUL	0
Compressed On	SI	15
Compressed print	SI	15
Condensed print	SI	15
Data cancel	CAN	24
Double-strike printing	ESC G	71
Double-strike printing Off	ESC H	72

Description	Code	ASCII Value
Double-width-by-line Off	DC4	20
Double-width-by-line On	SO	14
Double-width On (lines)	ESC W	87
Double-width printing (lines)	ESC W	87
Eject form	FF	12
Eject paper	FF	12
Emphasized printing	ESC E	69
Emphasized printing Off	ESC F	70
Escape	ESC	27
Feed line	LF	10
Form feed	FF	12
Graphics, 480 bit-image	ESC K	75
Graphics, 960 bit-image, 1/2 speed	ESC L	76
Graphics, 960 bit-image, full speed	ESC Y	89
Graphics 1920 bit-image	ESC Z	90
Head, home	ESC <	60
Home head	ESC <	60
Horizontal tab	HT	9
Horizontal tab stops set	ESC D	68
Ignore paper end	ESC 8	56
Ignore paper end, cancel	ESC 8	56
Length-of-page set in inches	ESC C	67
Length-of-page set in lines	ESC C	67
Line-feed, set 1/6 inch	LF	10
Line-feed, set 1/8 inch	ESC 0	48
Line-feed, set 7/72 inch	ESC 1	49
Line-feed, set variable	ESC 3	51
Line-feed, set variable	ESC A	65
Line-feed, set variable	ESC J	74
Line-feed, start variable	ESC 2	50
Line-feed, set variable	ESC J	74
Null	NUL	0
Page eject	FF	12
Page length, set in inches	ESC C	67
Page length, set in lines	ESC C	67
Paper eject	FF	12
Paper end, ignore	ESC 8	56
Perforation skip Off	ESC O	79
Perforation skip set	ESC N	78

Description	Code	ASCII Value
Print double-width one line	SO	14
Print double-width multiple lines	ESC W	87
Print emphasized	ESC E	69
Print emphasized Off	ESC F	70
Print 10 characters per inch	DC2	18
Print unidirectional On/Off	ESC U	85
Printer buffer, clear	CAN	24
Return carriage	CR	13
Select character set 1	ESC 7	55
Select character set 2	ESC 6	54
Set 1 (character set 1)	ESC 7	55
Set 1/8-inch line feed	ESC 0	48
Set 2 (character set 2)	ESC 6	54
Set 7/72-inch line feed	ESC 1	49
Set variable line feed	ESC 3	51
Set horizontal tab stops	ESC D	68
Set page length in lines	ESC C	67
Set page length in inches	ESC C	67
Set perforation skip	ESC N	78
Set variable line feed	ESC A	65
Skip perforation Off	ESC O	79
Skip perforation On	ESC N	78
Start 7/72 inch line feed	ESC 1	49
Start double-strike print	ESC G	71
Start double-width print by line	SO	14
Start double-width print (lines)	ESC W	87
Start emphasized print	ESC E	69
Start perforation skip	ESC N	78
Start subscript/superscript	ESC S	83
Start variable line feed	ESC 2	50
Start underline	ESC -	45
Stop double-strike print	ESC H	72
Stop double-width by line	DC4	20
Stop double-width print (lines)	ESC W	87
Stop emphasized print	ESC F	70
Stop perforation skip	ESC O	79
Stop subscript/superscript	ESC T	84
Stop superscript/subscript	ESC T	84
Stop underline	ESC -	45

Description	Code	ASCII Value
Stops, horizontal tabs, set	ESC D	68
Subscript/superscript Off	ESC T	84
Subscript/superscript On	ESC S	83
Tab horizontal	HT	9
Tab stops, horizontal, set	ESC D	68
Tabs horizontal set	ESC D	68
Underline On	ESC -	45
Unidirectional printing Off	ESC U	85
Unidirectional printing On	ESC U	85
Variable line feed	ESC 3	54
Variable line feed set	ESC 3	65
Variable line feed set	ESC J	74
Vertical tabs set	ESC B	66

Print Mode Combinations

The IBM Graphics Printer can use any of the combinations of print modes listed in the following table. The print mode can be changed at any place within a line. Modes can be selected and combined if they are in the same vertical column.

Printer Modes												
Normal	X	X	X									
Compressed				X	X	X						
Emphasized								X	X	X		
Double Strike	X			X				X				
Subscript		X			X				X			
Superscript			X			X						X
Double Width	X	X	X	X	X	X		X	X	X		
Underline	X	X	X	X	X	X		X	X	X		

Graphics Printer Character Set

The tables on the following pages show each character with its respective ASCII value.



0	1	2	3	4	5	6	7	8	9
NUL							BEL		HT
10	11	12	13	14	15	16	17	18	19
LF	VT	FF	CR	SO	SI			DC2	
20	21	22	23	24	25	26	27	28	29
DC4				CAN			ESC		
30	31	32	33	34	35	36	37	38	39
		SP	!	''	#	\$	%	&	'
40	41	42	43	44	45	46	47	48	49
()	*	+	,	—	.	/	0	1
50	51	52	53	54	55	56	57	58	59
2	3	4	5	6	7	8	9	:	;
60	61	62	63	64	65	66	67	68	69
<	=	>	?	@	A	B	C	D	E
70	71	72	73	74	75	76	77	78	79
F	G	H	I	J	K	L	M	N	O
80	81	82	83	84	85	86	87	88	89
P	Q	R	S	T	U	V	W	X	Y
90	91	92	93	94	95	96	97	98	99
Z	[\]	^	_	`	a	b	c
100	101	102	103	104	105	106	107	108	109
d	e	f	g	h	i	j	k	l	m
110	111	112	113	114	115	116	117	118	119
n	o	p	q	r	s	t	u	v	w
120	121	122	123	124	125	126	127	128	129
x	y	z	{		}	~	DEL	NUL	

Graphics Printer Character Set 1 (Part 1 of 2)

130	131	132	133	134	135	136	137	138	139
					BEL		HT	LF	VT
140	141	142	143	144	145	146	147	148	149
FF	CR	SO	SI			DC2		DC4	
150	151	152	153	154	155	156	157	158	159
		CAN			ESC				
160	161	162	163	164	165	166	167	168	169
á	í	ó	ú	ñ	Ñ	a	o	¿	⌞
170	171	172	173	174	175	176	177	178	179
⌞	½	¼	¡	<<	>>	■	■	■	■
180	181	182	183	184	185	186	187	188	189
⌞	⌞	⌞	⌞	⌞	⌞	⌞	⌞	⌞	⌞
190	191	192	193	194	195	196	197	198	199
⌞	⌞	⌞	⌞	⌞	⌞	⌞	⌞	⌞	⌞
200	201	202	203	204	205	206	207	208	209
⌞	⌞	⌞	⌞	⌞	⌞	⌞	⌞	⌞	⌞
210	211	212	213	214	215	216	217	218	219
⌞	⌞	⌞	⌞	⌞	⌞	⌞	⌞	⌞	■
220	221	222	223	224	225	226	227	228	229
■	■	■	■	α	β	Γ	Π	Σ	σ
230	231	232	233	234	235	236	237	238	239
μ	τ	ϕ	θ	Ω	δ	∞	∅	ε	∩
240	241	242	243	244	245	246	247	248	249
≡	±	≥	≤	∫	J	÷	≈	○	■
250	251	252	253	254	255				
-	√	n	²	■	SP				

Graphics Printer Character Set 1 (Part 2 of 2)

0	1	2	3	4	5	6	7	8	9
NUL			♥	♦	♣	♠	BEL		HT
10	11	12	13	14	15	16	17	18	19
LF		FF	CR	SO	S1			DC2	
20	21	22	23	24	25	26	27	28	29
DC4	§			CAN			ESC		
30	31	32	33	34	35	36	37	38	39
		SP	!	''	#	\$	%	&	'
40	41	42	43	44	45	46	47	48	49
()	*	+	,	—	.	/	0	1
50	51	52	53	54	55	56	57	58	59
2	3	4	5	6	7	8	9	:	;
60	61	62	63	64	65	66	67	68	69
<	=	>	?	@	A	B	C	D	E
70	71	72	73	74	75	76	77	78	79
F	G	H	I	J	K	L	M	N	O
80	81	82	83	84	85	86	87	88	89
P	Q	R	S	T	U	V	W	X	Y
90	91	92	93	94	95	96	97	98	99
Z	[\]	^	_	`	a	b	c
100	101	102	103	104	105	106	107	108	109
d	e	f	g	h	i	j	k	l	m
110	111	112	113	114	115	116	117	118	119
n	o	p	q	r	s	t	u	v	w
120	121	122	123	124	125	126	127	128	129
x	y	z	{		}	~		ç	ü

Graphics Printer Character Set 2 (Part 1 of 2)

130	131	132	133	134	135	136	137	138	139
é	â	ä	à	å	ç	ê	ë	è	ï
140	141	142	143	144	145	146	147	148	149
î	ì	Ä	Å	É	æ	Æ	ô	ö	ò
150	151	152	153	154	155	156	157	158	159
û	ù	ÿ	ö	ü	ç	£	¥	₹	f
160	161	162	163	164	165	166	167	168	169
á	í	ó	ú	ñ	Ñ	á	ó	¿	⌞
170	171	172	173	174	175	176	177	178	179
⌞	½	¼	ï	<<	>>	▒	▒	▒	▒
180	181	182	183	184	185	186	187	188	189
⌞	⌞	⌞	⌞	⌞	⌞	⌞	⌞	⌞	⌞
190	191	192	193	194	195	196	197	198	199
⌞	⌞	⌞	⌞	⌞	⌞	⌞	⌞	⌞	⌞
200	201	202	203	204	205	206	207	208	209
⌞	⌞	⌞	⌞	⌞	⌞	⌞	⌞	⌞	⌞
210	211	212	213	214	215	216	217	218	219
⌞	⌞	⌞	⌞	⌞	⌞	⌞	⌞	⌞	⌞
220	221	222	223	224	225	226	227	228	229
▒	▒	▒	▒	α	β	Γ	Π	Σ	σ
230	231	232	233	234	235	236	237	238	239
μ	τ	ϕ	θ	Ω	δ	∞	∅	€	∩
240	241	242	243	244	245	246	247	248	249
≡	±	≥	≤	∫	J	÷	≈	○	■
250	251	252	253	254	255				
-	√	n	2	■	SP				

Graphics Printer Character Set (Part 2 of 2)

DIP-Switch Settings

There are two DIP switches on the control circuit board. In order to satisfy the user's specific requirements, desired control modes are selectable by the DIP switches. The functions of the switches and their preset conditions at the time of shipment are as shown in the following figures.

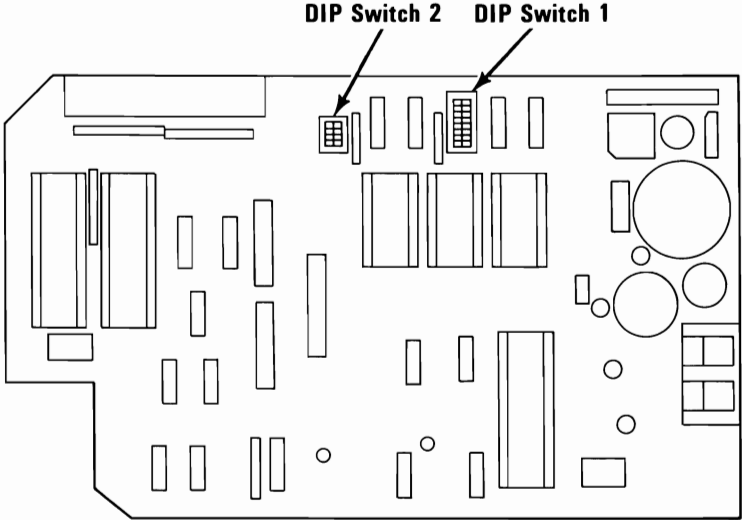

Location of Printer DIP Switches

Switch Number	Function	On	Off	Factory-Set Condition
1-1	Not Applicable	—	—	On
1-2	CR	Print Only	Print & Line Feed	On
1-3	Buffer Full	Print Only	Print & Line Feed	Off
1-4	Cancel Code	Invalid	Valid	Off
1-5	Not Applicable	—	—	On
1-6	Error Buzzer	Sound	Does Not Sound	On
1-7	Character Generator	Set 2	Set 1	Off
1-8	SLCT IN Signal	Fixed Internally	Not Fixed Internally	On

Functions and Conditions of DIP Switch 1 (Graphics)

Switch Number	Function	On	Off	Factory-Set Condition
2-1	Form Length	304.8 mm (12 inches)	279.4 mm (11 inches)	Off
2-2	Line Spacing	3.175 mm (1/8 inch)	4.23 mm (1/6 inch)	Off
2-3	Auto Feed XT Signal	Fixed Internally	Not Fixed Internally	Off
2-4	1 Inch Skip Over Perforation	Valid	Not Valid	Off

Functions and Conditions of DIP Switch 2 (Graphics)



Interface

Specifications:

- Data transfer rate: 1000 cps (maximum)
- Synchronization: By externally-supplied $\overline{\text{STROBE}}$ pulses.
- Handshaking $\overline{\text{ACKNLG}}$ or BUSY signals.
- Logic level: Input data and all interface control signals are compatible with the TTL level.

Connector type: 57-30360 (Amphenol)

Data Transfer Sequence:

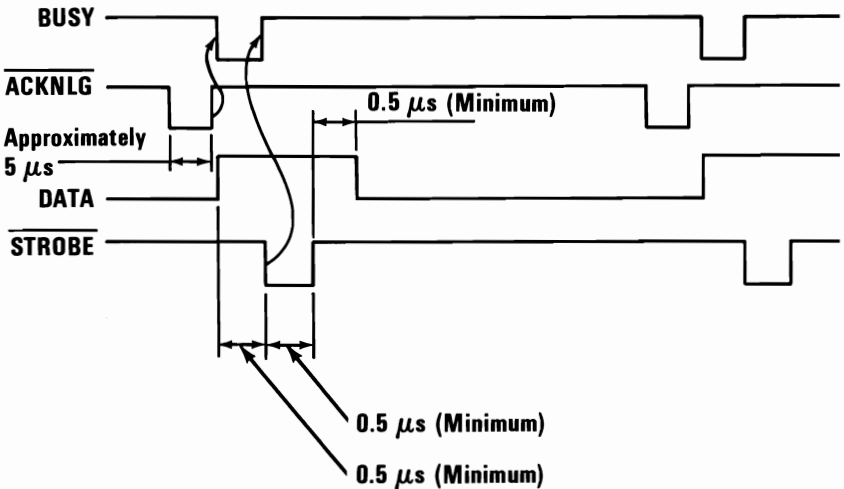

Parallel Interface Timing Diagram



Specifications

Size	
Height	107 mm (4.2 in.)
Width	400 mm (15.7 in.)
Depth	305 mm (12 in.)
Weight	
	5.5 kg (12 lb)
Power Cable	
Length	1.83 m (6 ft)
Size	18 AWG
Signal Cable	
Length	1.83 m (6 ft)
Size	22 AWG

Physical Specifications

Voltage (Vac)			Frequency (Hz)	Current (Amps)	Power (Watts)
Nominal	Minimum	Maximum	± 3 Hz	Maximum	Maximum
120	104	127	60	1.0	100
220	198	242	50/60	0.5	100
240	216	264	50/60	0.5	100

Electrical Specifications

Print Method	Serial-impact wire matrix	
Print Speed	80 cps	
Print Direction	Bidirectional with logical seeking	
Number of Pins in Head	9	
Line Spacing	4.23 mm (1/6 in.) or programmable	
Printing Characteristics		
Matrix	9 x 9	
Graphic Character	See "Graphics Printer Character Set" tables.	
Printing Sizes		
	Characters per inch	Maximum characters per line
Normal	10	80
Double Width	5	40
Compressed	17.1	132
Double Width-Compressed	8.25	66
Subscript	10	80
Superscript	10	80
Media Handling		
Paper Feed	Adjustable sprocket pin feed	
Paper Width Range	101.6 mm (4 in.) to 254 mm (10 in.)	
Copies	One original plus two carbon copies (total thickness not to exceed 0.3 mm (0.012 in.)). Minimum paper thickness is 0.064 mm (0.0025 in.).	
Paper Path	Rear	
Interfaces		
Standard	Parallel 8-bit Data and Control Lines	
Inked Ribbon		
Color	Black	
Type	Cartridge	
Life Expectancy	3 million characters	
Environmental Conditions		
Operating Temperature	5 to 35°C (41 to 95°F)	
Operating Humidity	10 to 80% non-condensing	
Heat Output	341 BTU/hr (maximum)	

Printer Specifications

Connector Pin Assignments

Signal Pin No.	Return Pin No.	Signal	Direction	Description
1	19	STROBE	In	STROBE pulse to read data in. Pulse width must be more than 0.5 μ s at receiving terminal. The signal level is normally "high"; read-in of data is performed at the "low" level of this signal.
2	20	DATA 1	In	These signals represent information of the 1st to 8th bits of parallel data respectively. Each signal is at "high" level when data is logical "1" and "low" when logical "0."
3	21	DATA 2	In	
4	22	DATA 3	In	
5	23	DATA 4	In	
6	24	DATA 5	In	
7	25	DATA 6	In	
8	26	DATA 7	In	
9	27	DATA 8	In	
10	28	ACKNLG	Out	Approximately 5 μ s pulse; "low" indicates that data has been received and the printer is ready to accept other data.
11	29	BUSY	Out	A "high" signal indicates that the printer cannot receive data. The signal becomes "high" in the following cases: <ol style="list-style-type: none"> 1. During data entry. 2. During printing operation. 3. In "offline" state. 4. During printer error status.

Connector Pin Assignment and Descriptions of Interface Signals (Part 1 of 3)

Signal Pin No.	Return Pin No.	Signal	Direction	Description
12	30	PE	Out	A "high" signal indicates that the printer is out of paper.
13	—	SLCT	Out	This signal indicates that the printer is in the selected state.
14	—	$\overline{\text{AUTO FEED XT}}$	In	With this signal being at "low" level, the paper is automatically fed one line after printing. (The signal level can be fixed to "low" with DIP SW pin 2-3 provided on the control circuit board.)
15	—	NC		Not used.
16	—	OV		Logic GND level.
17	—	CHASSIS-GND	—	Printer chassis GND. In the printer, the chassis GND and the logic GND are isolated from each other.
18	—	NC	—	Not used.
19-30	—	GND	—	"Twisted-Pair Return" signal; GND level.
31	—	$\overline{\text{INIT}}$	In	When the level of this signal becomes "low" the printer controller is reset to its initial state and the print buffer is cleared. This signal is normally at "high" level, and its pulse width must be more than 50 μs at the receiving terminal.

Connector Pin Assignment and Descriptions of Interface Signals (Part 2 of 3)

Signal Pin No.	Return Pin No.	Signal	Direction	Description
32		$\overline{\text{ERROR}}$	Out	The level of this signal becomes "low" when the printer is in "Paper End" state, "Offline" state and "Error" state.
33	—	GND	—	Same as with pin numbers 19 to 30.
34	—	NC	—	Not used.
35				Pulled up to +5 Vdc through 4.7 k-ohms resistance.
36	—	$\overline{\text{SLCT IN}}$	In	Data entry to the printer is possible only when the level of this signal is "low." (Internal fixing can be carried out with DIP SW 1-8. The condition at the time of shipment is set "low" for this signal.)
<p>Notes:</p> <ol style="list-style-type: none"> "Direction" refers to the direction of signal flow as viewed from the printer. "Return" denoted "Twisted-Pair Return" and is to be connected at signal-ground level. When wiring the interface, be sure to use a twisted-pair cable for each signal and never fail to complete connection on the return side. To prevent noise effectively, these cables should be shielded and connected to the chassis of the system unit and printer, respectively. All interface conditions are based on TTL level. Both the rise and fall times of each signal must be less than 0.2 μs. Data transfer must not be carried out by ignoring the $\overline{\text{ACKNLG}}$ or BUSY signal. (Data transfer to this printer can be carried out only after confirming the $\overline{\text{ACKNLG}}$ signal or when the level of the BUSY signal is "low.") 				

Connector Pin Assignment and Descriptions of Interface Signals (Part 3 of 3)

1
4



Logic Diagrams

The following page and foldout contain the logic diagrams for the IBM Graphics Printer.



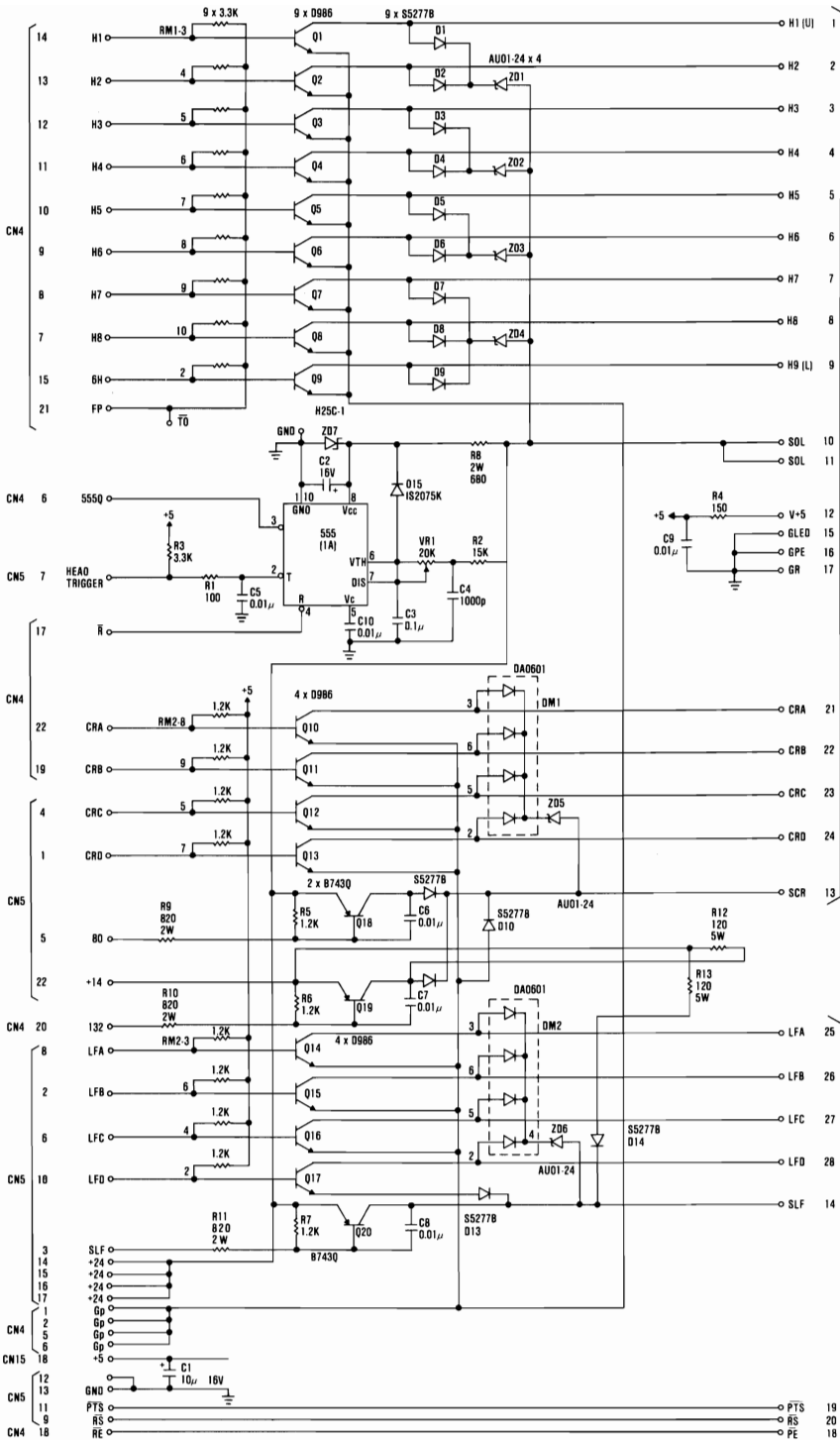

Graphics Printer (Sheet 1 of 2)

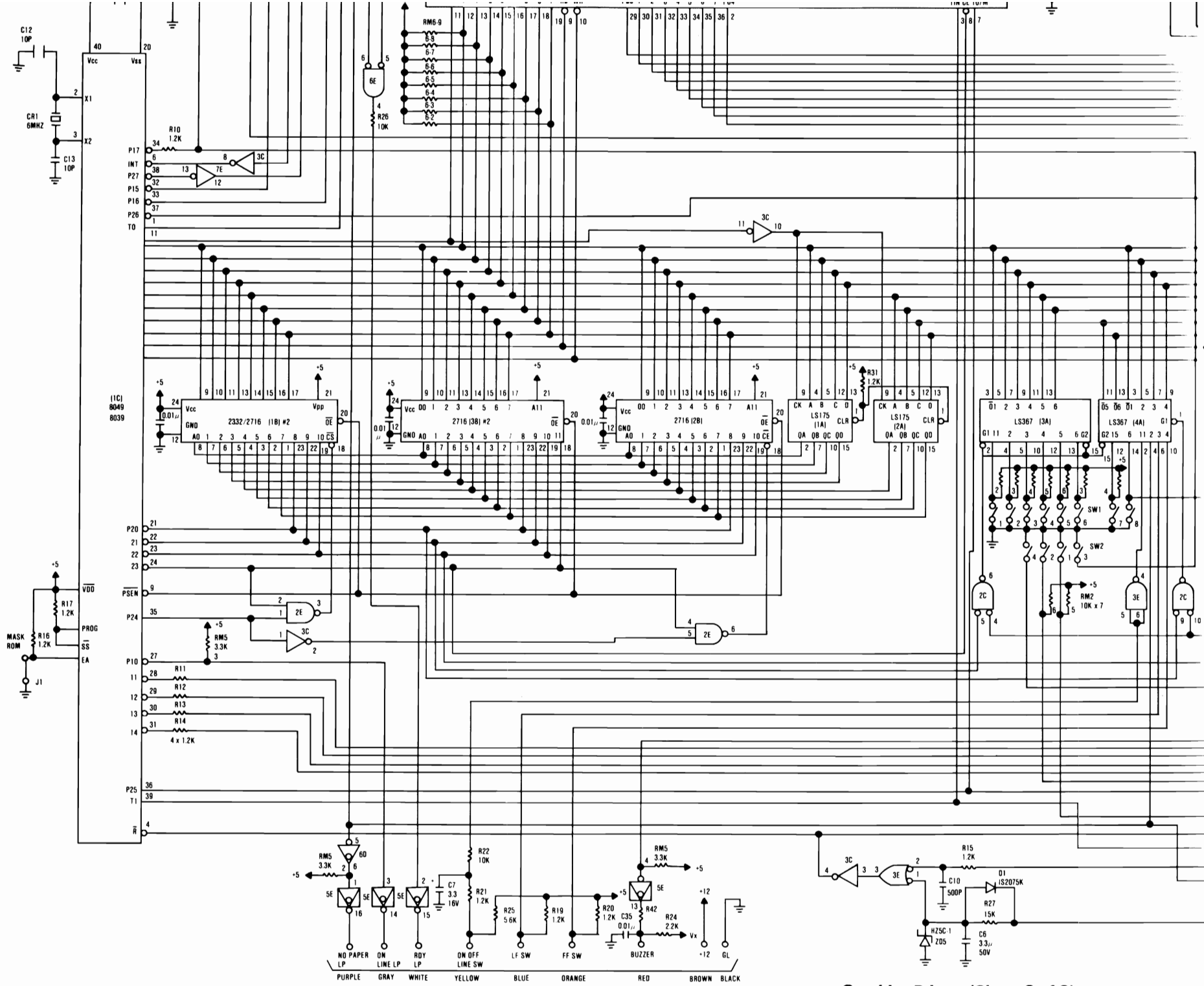

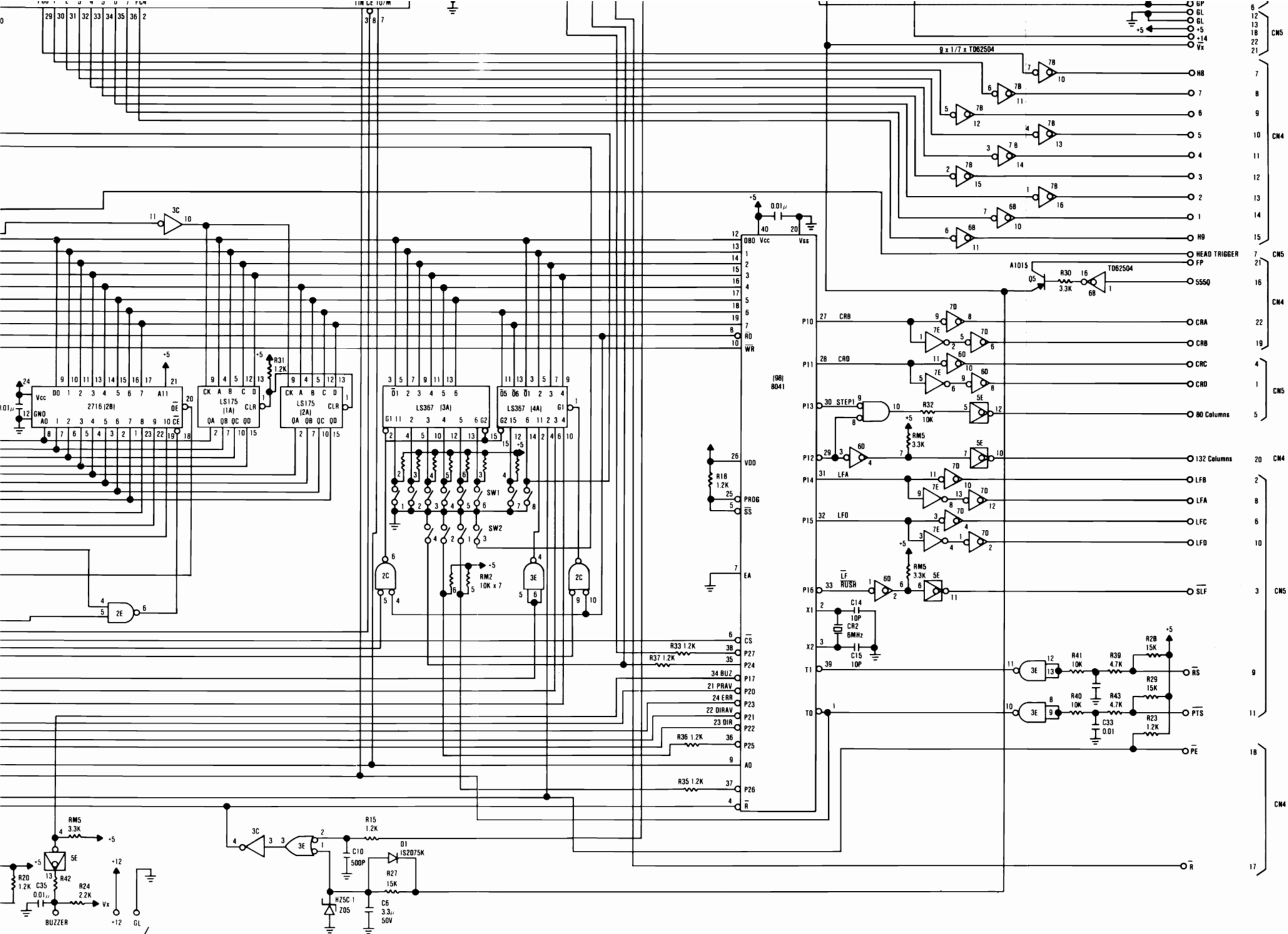

Graphics Printer (Sheet 2 of 2)

Graphics Printer 35/36

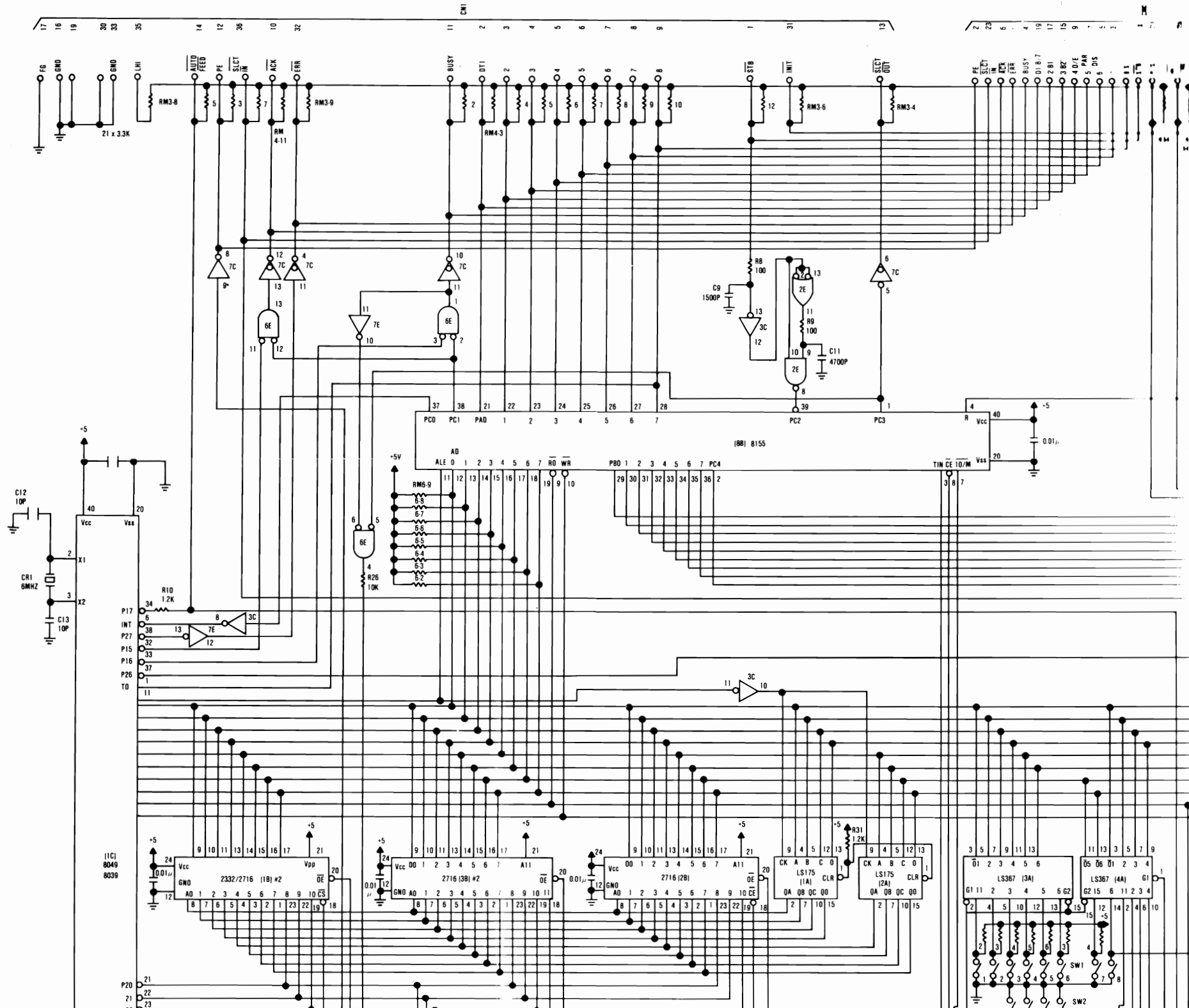

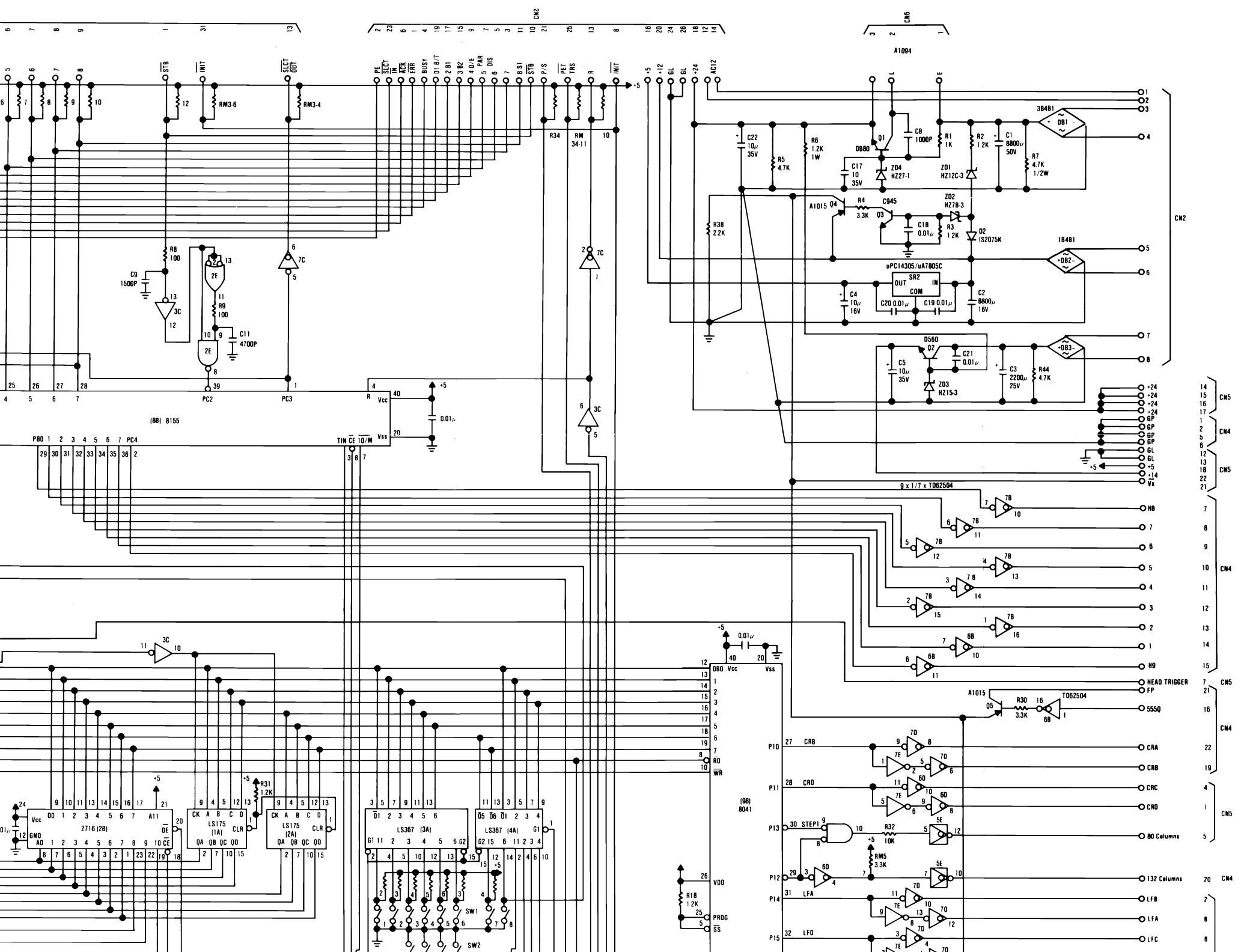

CN2
2 23
6 6
1 1
19 19
17 17
15 15
9 9
7 7
5 5
3 3
11 11
10 10
21 21
25 25
13 13
8 8

CN6
3
2
1

CN2

CN5

CN4

CN5

CN4

CN5

CN4

CN5

CN4

CN5

CN4

CN5

CN4

CN5

CN4

CN5

CN4

CN5

CN4

CN5

CN4