



The Windows™ Color Presentation Printer

WinType 800C

Users Manual

Federal Communications Commission Radio Frequency Interference Statement

This equipment has been tested and found to comply with the limits for a Class B digital device, pursuant to Part 15 of FCC rules. These limits are designed to provide reasonable protection against harmful interference in a residential installation. This equipment generates, uses and can radiate radio frequency energy and, if not installed and used in accordance with the instructions, may cause harmful interference to radio communications. However, there is no guarantee that interference will not occur in a particular installation. If this equipment does cause harmful interference to radio or television reception, which can be determined by turning the equipment off and on, the user is encouraged to try to correct the interference by one or more of the following measures.

- Reorient or relocate the receiving antenna.
- Increase the separation between the equipment and receiver.
- Connect the equipment into an outlet on a circuit different from that to which the receiver is connected.
- Consult the dealer or an experienced radio/TV technician for help.

Note: The following cable must be used to comply with FCC Regulations as well as to avoid interference to home equipment.

Interface cable: Twisted-pair shielded cable

Non-shielded A.C. Power Cord

Do not attempt to modify this equipment. If modified, your authority to operate this equipment might be voided by the FCC.

The above statement applies only to printers marketed in the U.S.A.

Statement of The Canadian Department of Communications Radio Interference Regulations

This digital device does not exceed the Class B limits for radio noise emissions from digital apparatus set out in the Radio Interference Regulations of the Canadian Department of Communications.

Le présent appareil numérique n'émet pas de bruits radioélectriques dépassant les limites applicables aux appareils numériques de la classe B prescrites dans le Règlement sur le brouillage radioélectrique édicté par le ministère des Communications du Canada.

The above statement applies only to printers marketed in Canada.

Bescheinigung des Importeurs

Hiermit wird bescheinigt, daß der

COMPUTER DRUCKER TM300

in Übereinstimmung mit den Bestimmungen der

VDE 0878 3/22.89, EN 55022: 1987, BMPT Vfg. 243/1991 und 46/1992

funk-entstört ist.

Dem Bundesamt für Zulassungen in der Telekommunikation wurde das Inverkehrbringen dieses Gerätes angezeigt und die Berechtigung zur Überprüfung der Serie auf die Einhaltung der Bestimmungen eingeräumt.

Star Micronics Deutschland, GmbH

Westerbachstraße 59, D-60489

Frankfurt, Germany

The above statements apply only to printers marketed in Germany.

Trademark Acknowledgments

TrueType: Apple Computer, Inc.

Windows 3.1, MS-DOS: Microsoft Corporation

Notice

- All rights reserved. Reproduction of any part of this manual in any form whatsoever without STAR'S express permission is forbidden.
- The contents of this manual are subject to change without notice.
All efforts have been made to ensure the accuracy of the contents of this manual at the time of press. However, should any errors be detected, STAR would greatly appreciate being informed of them.
- The above notwithstanding, STAR can assume no responsibility for any errors in this manual.

©Copyright 1994 Star Micronics Co., Ltd.

Contents

Introduction	iii
A word about the printer	iii
System requirements	iii
This users manual	iii
How to use this manual	iv
Features of the printer	iv
Printer components	v
Chapter 1 Setting up your printer	1
Unpacking and checking the package contents	1
Package contents	1
Genuine Star supplies	2
Placing the printer	3
Preparing to print	3
Loading coated paper	4
Installing the film roll	5
Connecting the power cord	8
Performing a test print	8
Connecting the printer to your computer	9
Chapter 2 Installing the printer driver and TrueType fonts	11
System requirements	11
Installing the printer driver and TrueType fonts	11
TrueType font samples	14
Chapter 3 Printing with WinType 800C	15
The control panel	15
The Paper lamp	15
The Film Roll lamp	15
The Ready lamp	15
The Ready button	15
Features of the printer	16
Recommended print media	16
Operating the printer	17
Turning ON the power to the printer	17
Turning OFF the power to the printer	17
Loading print media	17
The paper tray	17
Manual loading	19
Printable area	19

Getting ready to print	21
Printing	23
DIP switch settings	23
Changing halftones and image quality	24
Changing halftones	24
Changing gamma correction	25
Changing color balance	26
High speed printing	26
Print speed	28
Other buttons in the Options dialog box	29
Black Representation	29
Intensity	30
Photo	30
Text	30
Printing on Special A4 and Legal size media	31
Replacing the film roll	33
Changing the film roll setting	35
Printing with iron-on transfer	37
Steps for printing on the transfer sheets	37
Steps for transferring the image on the cloth	38
Steps for the finishing process	39
Chapter 4 Maintenance & troubleshooting	41
Maintaining your printer	41
Cleaning the outside of the printer	41
Cleaning the inside of the printer	41
Clearing paper jams	46
Transporting your printer	48
Troubleshooting	51
Other DIP switch settings	55
Pinout of interface connector	56
Chapter 5 Reference information	57
Specifications	57
Glossary	60
Index	64

Introduction

Thank you for purchasing the Star WinType 800C color presentation laser quality printer. This Users Manual has been organized into five chapters, a glossary and an index to help you learn the proper operation and care of your printer. The first three chapters explain the basic care and handling of this printer and the operation of the printer driver software. The remaining chapters are intended as a reference guide for troubleshooting any printing problems you may encounter.

A word about the printer

The Star WinType 800C is a new type of color presentation laser quality printer that has been developed specifically for users of Windows™ version 3.1. This printer comes with the WinType software and it does not require special add-in cards or cartridges. This printer will only print from Windows applications. It will not function in any DOS application.

System requirements

To operate this printer you need an IBM compatible PC with at least a 386SX 16-MHz CPU and at least 8 megabytes (MB) of PC memory (RAM). The PC must be running DOS 3.3 or later and Windows 3.1 in Enhanced Mode. A Microsoft-compatible mouse is highly recommended. You must also have a 3.5" floppy disk drive. A standard PC parallel printer port is required to connect the printer using a standard high quality shielded Centronics parallel cable.

This users manual

Chapter 1 Setting up your printer

This chapter explains the basic procedures for unpacking, placing and connecting your printer.

Chapter 2 Installing the printer driver software and TrueType fonts

This chapter details the procedures used to install the Star WinType 800C printer driver software and TrueType fonts. You must install the printer driver software to be able to print.

Chapter 3 Printing

This chapter explains how to operate your printer and the printer driver software.

Chapter 4 Maintenance & troubleshooting

This chapter explains the proper procedures for routine maintenance and care of your printer and a quick reference to help you solve any problems which you may occur.

Chapter 5 Reference information

This chapter lists the printer's specifications.

Glossary

This provides you with the definitions of commonly used printer and computer words.

Index

This lists, in alphabetical order, topics which appear in this manual.

How to use this manual

Each chapter provides you with simple explanations of the printer's operation. We have included illustrations of the printer and Windows screens wherever necessary and wherever space allowed. You should be able to operate this printer by carefully following each of the steps provided.

Features of the printer

This printer is capable of laser quality color page printing on Letter, A4, Legal and Special A4 size coated, presentation quality smooth paper, OHP (overhead projection) film and iron-on transfer sheets.

The main features of the printer include:

- Full color and monochrome laser quality printing
- Up to 2 pages per minute using monochrome film rolls and 1 page per minute using 4 color film rolls.
- Laser quality 300 dots per inch resolution
- Prints documents made using virtually any Windows 3.1 application software
- 35 Scalable TrueType fonts for Windows 3.1 applications
- Meets or exceeds all requirements of the Environmental Protection Agency's Energy Star program
- Printouts require no drying time
- Printouts do not bleed, smear nor wrinkle
- Compact and stylish design

Printer components

Paper tray

The paper tray cover and the paper tray base, when put together, are called the paper tray.

Paper tray cover

This covers the paper tray.

Paper tray base

This holds your print media.

Control panel

The control panel includes the Ready button and the Ready, Paper and Film Roll lamps.

Top cover release

Press this to open the printer's top cover.

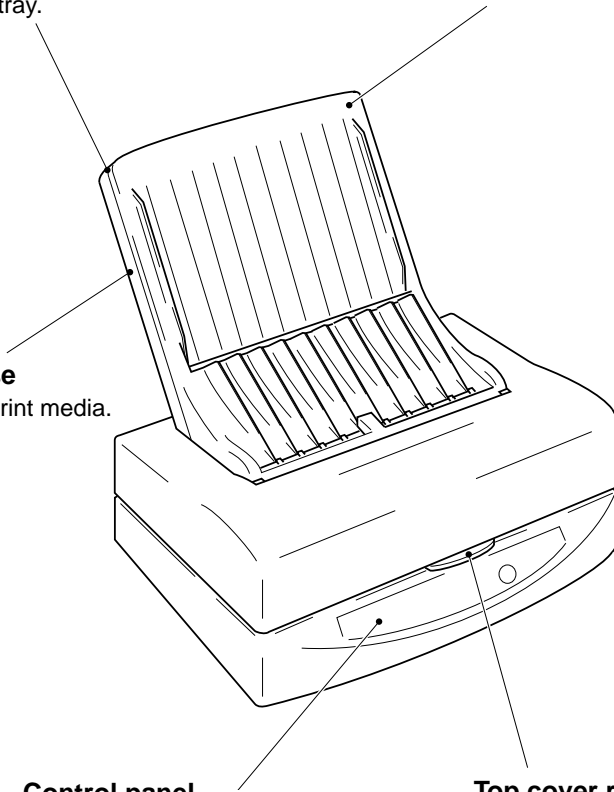

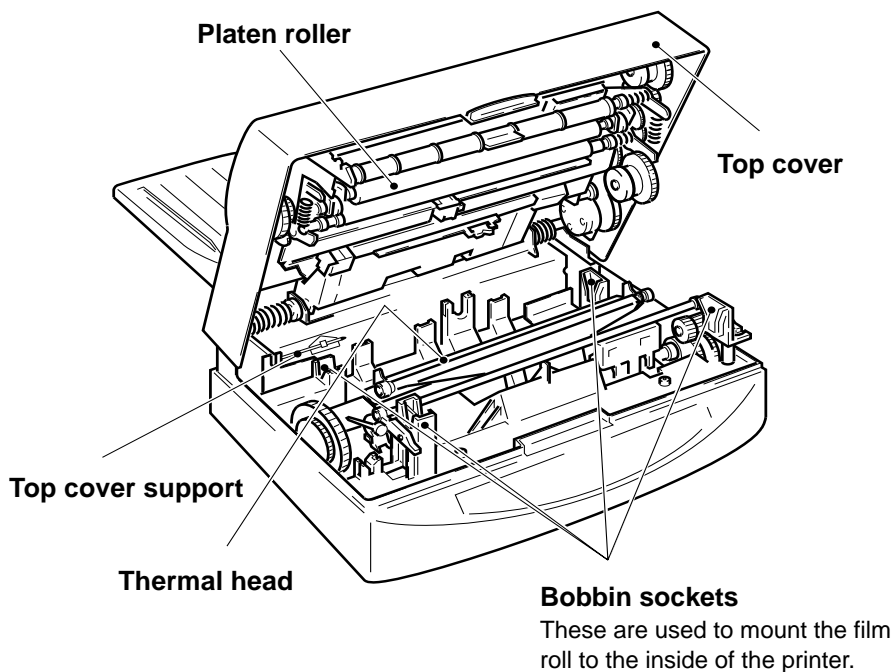
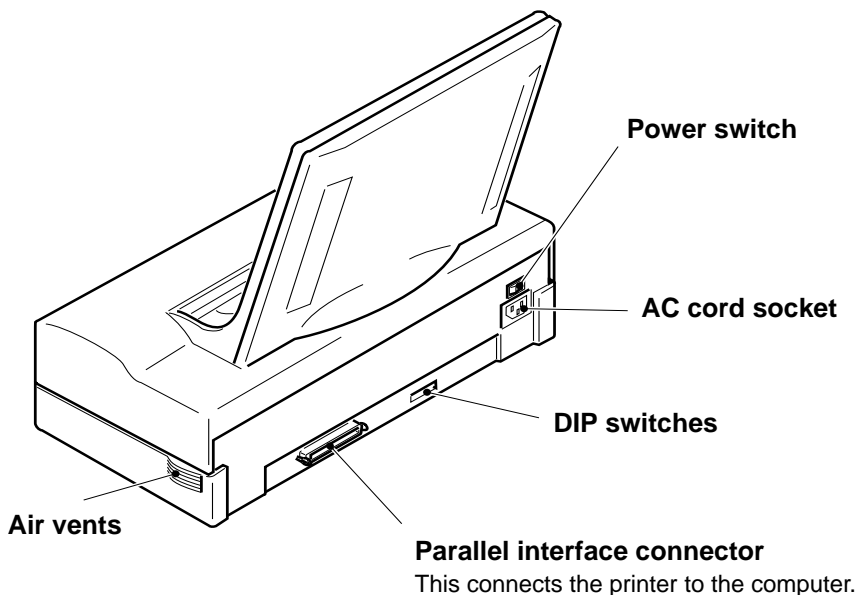

Federal Communications Commission Radio Frequency Interference Statement

This equipment has been tested and found to comply with the limits for a Class B digital device, pursuant to Part 15 of FCC rules. These limits are designed to provide reasonable protection against harmful interference in a residential installation. This equipment generates, uses and can radiate radio frequency energy and, if not installed and used in accordance with the instructions, may cause harmful interference to radio communications. However, there is no guarantee that interference will not occur in a particular installation. If this equipment does cause harmful interference to radio or television reception, which can be determined by turning the equipment off and on, the user is encouraged to try to correct the interference by one or more of the following measures.

- Reorient or relocate the receiving antenna.
- Increase the separation between the equipment and receiver.
- Connect the equipment into an outlet on a circuit different from that to which the receiver is connected.
- Consult the dealer or an experienced radio/TV technician for help.

Note: The following cable must be used to comply with FCC Regulations as well as to avoid interference to home equipment.

Interface cable: Twisted-pair shielded cable

Non-shielded A.C. Power Cord

Do not attempt to modify this equipment. If modified, your authority to operate this equipment might be voided by the FCC.

The above statement applies only to printers marketed in the U.S.A.

Statement of The Canadian Department of Communications Radio Interference Regulations

This digital device does not exceed the Class B limits for radio noise emissions from digital apparatus set out in the Radio Interference Regulations of the Canadian Department of Communications.

Le présent appareil numérique n'émet pas de bruits radioélectriques dépassant les limites applicables aux appareils numériques de la classe B prescrites dans le Règlement sur le brouillage radioélectrique édicté par le ministre des Communications du Canada.

The above statement applies only to printers marketed in Canada.

Bescheinigung des Importeurs

Hiermit wird bescheinigt, daß der

COMPUTER DRUCKER TM300

in Übereinstimmung mit den Bestimmungen der

VDE0878 3/22. 89, EN 55022: 1987, BMPT Vfg. 243/1991 und 46/1992

funk-entstört ist.

Dem Bundesamt für Zulassungen in der Telekommunikation wurde das Inverkehrbringen dieses Gerätes angezeigt und die Berechtigung zur Überprüfung der Serie auf die Einhaltung der Bestimmungen eingeräumt.

STAR MICRONICS DEUTSCHLAND GMBH

Westerbachstraße 59, W-6000

Frankfurt/Main 90, Germany

The above statement applies only to printers marketed in Germany.

Trademark Acknowledgments

TrueType: Apple Computer, Inc.

Windows 3.1, MS-DOS: Microsoft Corporation

Notice

- All rights reserved. Reproduction of any part of this manual in any form whatsoever without STAR's express permission is forbidden.
- The contents of this manual are subject to change without notice.
All efforts have been made to ensure the accuracy of the contents of this manual at the time of press. However, should any errors be detected, STAR would greatly appreciate being informed of them.
- The above notwithstanding, STAR can assume no responsibility for any errors in this manual.

©Copyright 1994 Star Micronics Co., Ltd.

Chapter 1 Setting up your printer

Your printer is a reliable and quality precisioned instrument. However, it is every owner's responsibility to make sure that their equipment is properly placed and sensibly used. If the following conditions are met, you can expect your printer to perform at its finest and to last a long time.

Unpacking and checking the package contents

When you open the box, you will find the items in the list below included. While removing all of the packing materials, check to make sure that each item below has been included. There should be a total of ten items. If you are missing any of them, contact your dealer immediately.

Package contents

1. WinType 800C color presentation printer
2. Accessories carton containing the following items:
3. This Users Manual
4. Paper tray base
5. Paper tray cover
6. Starter 3-color film roll
7. Film roll bobbins
8. Starter paper (30 sheets)
9. Printer driver and font software (2 disks)
10. Power cable

We strongly recommend that you save the sales receipt, boxes and packing materials for this printer. They will protect the printer should you ever need to transport it to a new location or require service.

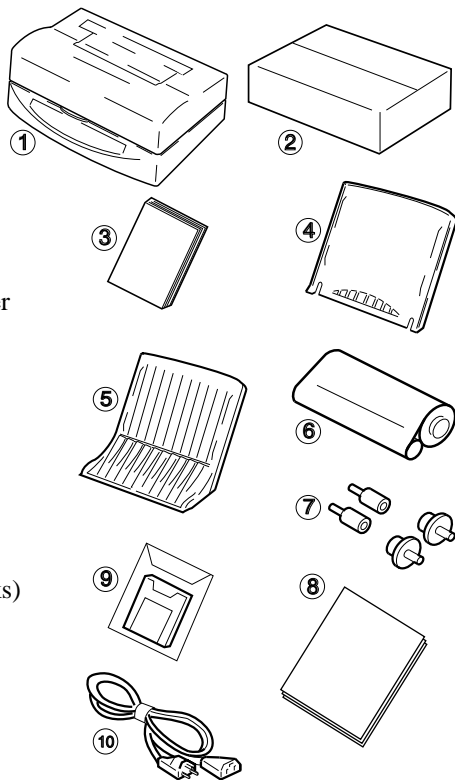

Caution: Always remove the film roll prior to transporting the printer. Failure to do so may result in permanent damage to your printer and may void your warranty. See page 48 for an explanation.

Note: The enclosed paper and 3 color film roll are samples supplied to help you get started printing quickly. These are sample supplies and have a limited yield of only 30 pages. You can purchase genuine Star Supplies from your Authorized Star Dealer. Your WinType 800C Windows Color Presentation Printer supports the genuine Star Supplies listed on the next page.

Genuine Star supplies

<u>Description</u>	<u>Model Number</u>	<u>Yield Per Roll</u>
3 color film roll (Letter/A4 size)	TL1-11C3H	80 pages
3 color film roll (Legal/Special A4 size)	TL1-14C3H	69 pages
4 color film roll (Letter/A4 size)	TL1-11C4H	59 pages
4 color film roll (Legal/Special A4 size)	TL1-14C4H	47 pages
Monochrome film roll	TL1-CBH	200 pages

Note: All film rolls are sold with 2 rolls per package.

<u>Description</u>	<u>Model Number</u>	<u>Size</u>	<u>Sheets/Pack</u>
Coated paper	A-PWC	Letter	100 sheets
	A4-PWC	A4	100 sheets
	SA-PWC	Legal	100 sheets
	SA4-PWC	Special A4	100 sheets
Presentation grade paper	A-PW	Letter	100 sheets
	A4-PW	A4	100 sheets
	SA-PW	Legal	100 sheets
	SA4-PW	Special A4	100 sheets
OHP film	A-TFC	Letter	100 sheets
	A4-TFC	A4	100 sheets
	SA-TFC	Legal	100 sheets
	SA4-TFC	Special A4 OHP	100 sheets
Iron-on transfer sheets	T90IO-A4	A4	10 sheets
	T90IO-LTR	Letter	10 sheets

Placing the printer

If you take good care of your printer, you can expect it to perform at its finest and to last for a very long time. You can do that by first setting your printer in an area which meets the following requirements.

- A firm, level surface which is free from vibration.
- An area free from excessive heat such as direct sunlight or heaters.
- A dust free environment.
- A steady power supply. Do not connect it to an outlet which uses the same circuit as a refrigerator or an air conditioner.
- Use only the line voltage specified on the identification plate.
- The printer should be positioned relatively close to the computer. The maximum recommended length of the parallel interface cable (not supplied) is 2 meters or 6 feet.
- The printer should be placed so that there is a minimum of 5 cm. (2 in.) clearance on the front, left and right sides to prevent blockage of its ventilation fan outlets and at least 30 cm. on the back of the printer to allow opening of the printer's top cover.

Preparing to print

After placing for your printer in a suitable area, you can begin preparing it to print. You must carefully follow the **Steps** below to properly and safely load the print media and install the film roll.

Note: The following **Steps** assume that you are using the starter film roll and the starter paper. Coated paper is included for the American market and presentation grade paper is included for other markets. See Chapter 3 for detailed explanations on printing with other print media.

Loading paper

You must always follow the **Steps** below to load paper **before** installing the film roll.

Steps:

1. Insert the paper tray base into the positioning holes at the back side of the printer.

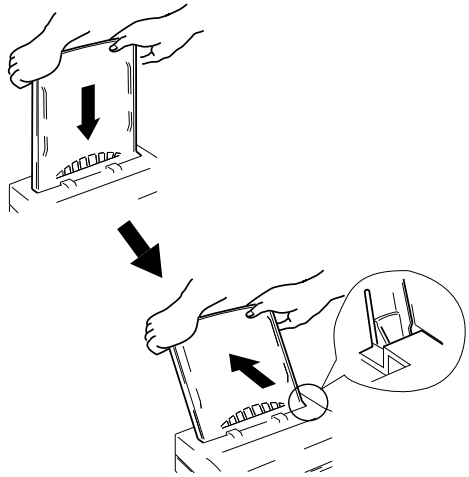

2. Fan the paper. This will prevent paper jams from occurring.

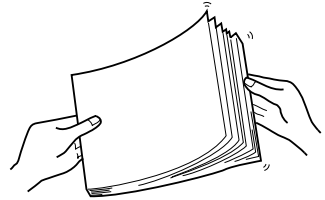

3. Load one sheet of paper into the paper tray base with the printing side facing the paper tray base.

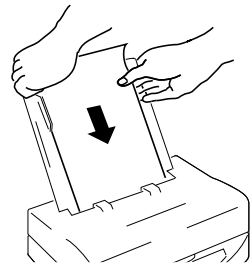

Note: Recommended coated paper will have the words "PRINT OPPOSITE SIDE" printed in light blue letters on the back side.

4. After one sheet has been inserted all the way into the printer, add the remainder of the stack of paper.

Note: The paper tray can hold up to 50 sheets of coated/presentation grade paper at one time. Be certain to insert the print media with the print side facing down when inserting into the printer.

5. After inserting the paper, place the paper tray cover on top of the paper tray base in the direction indicated by the arrows in the illustration at the right.

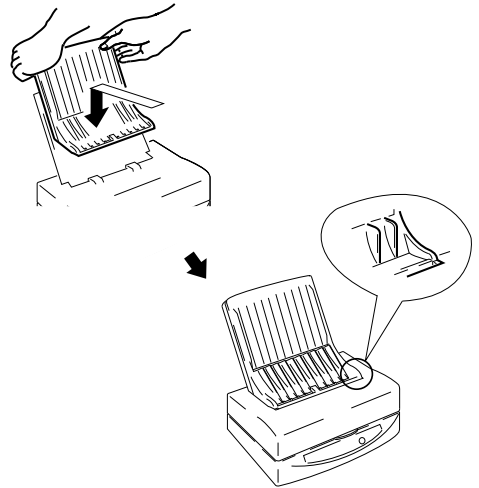

Installing the film roll

Caution: It is essential that you have paper in the paper tray, that the paper tray cover and the top cover support are in place when you open the top cover of the printer. Failing to do so will allow the top cover to drop down when opened. This can cause unexpected and painful injury.

Steps:

1. Insert the film roll bobbins into holes on both sides of the rolls. Be certain to insert the bobbins with wedges into the holes that are shaped in the same way. Those portions of the bobbins are colored green.

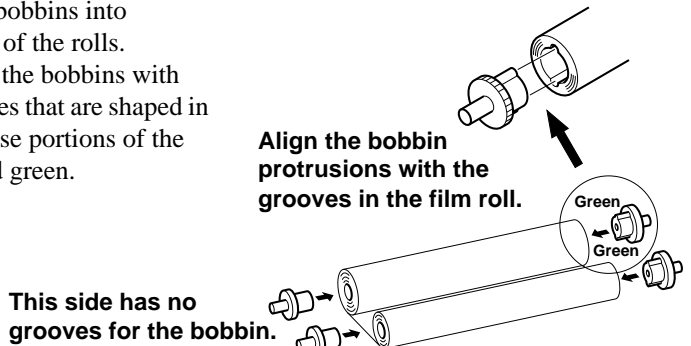

2. Unwrap the film roll and gently pull the two halves apart. They are held together with a light adhesive.

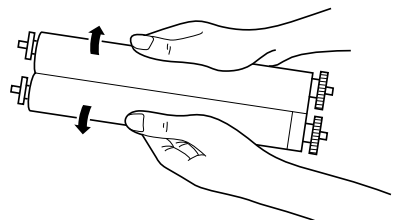

3. Press the cover release and open the top cover.

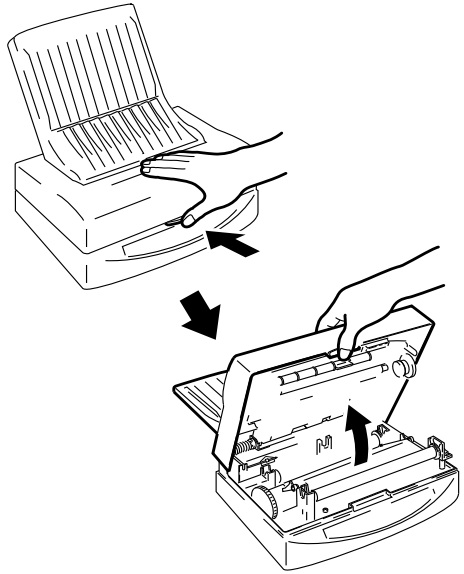

Caution: Always leave the paper tray and top cover support in place when opening the printer's top cover. Removing them while top cover is open will cause it to fall shut while your hands are inside the machine.

4. Lift up the Top Cover Support located on the left on the inside of the printer and slip the end of the support bar into the latch located on the inside of the Top Cover. Gently lower the Top Cover until it stops.

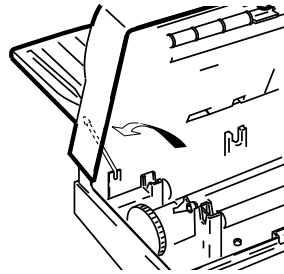

5. Remove the two protective transportation inserts and the socket protective transportation sheet from inside the printer.

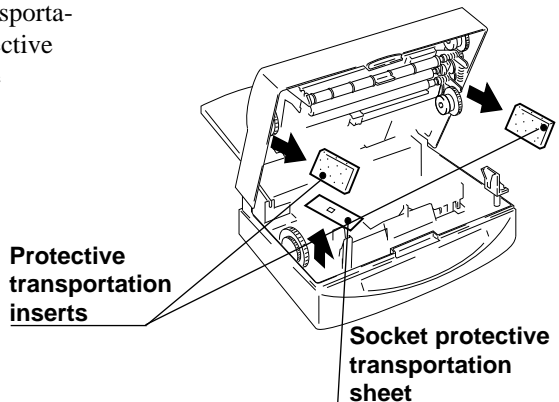

6. Place the larger half of the film roll into the rear portion of the printer. Fit the geared bobbin side into the slot first. Then slip the other end into the opposing slot. The smaller bobbin (on the left side) should pop into place. The bobbin and printer gears should mesh.

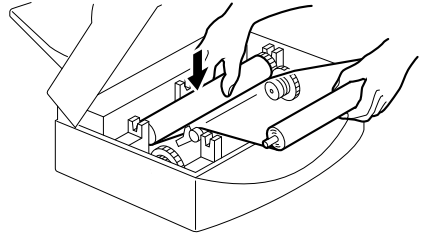

Insert the take-up roll (smaller half) into the slots in the front portion of the machine by following the procedures described above.

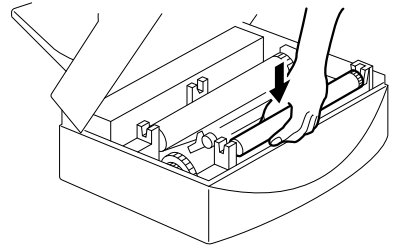

7. Gently rotate, toward the front of the printer, the gear of the film roll to take up any slack in the sheet.

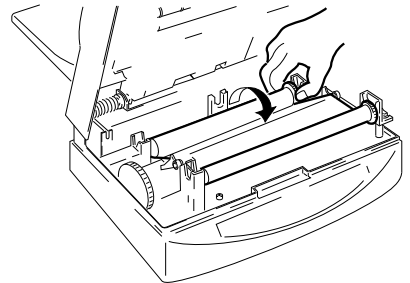

8. Lay the Top Cover Support Bar down to its original position while holding the top cover with one hand.

9. Gently, but firmly, close the printer's top cover by pushing down on it. When the top cover properly closes, you will hear the click of the latches.

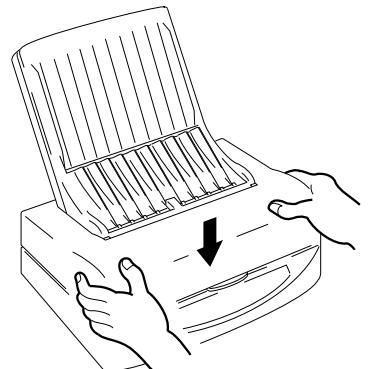

Connecting the power cord

Steps:

1. Make sure that the power switch, located on the back of the printer, is in the OFF [O] position.
2. Securely plug the power cord into the socket located at the rear of the printer.
3. Plug the other end of the power cord into a grounded wall outlet.

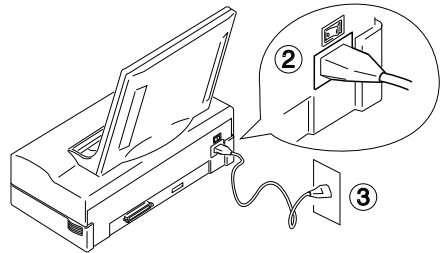
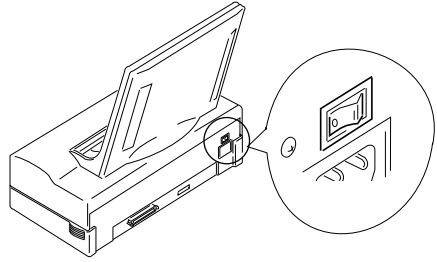

Performing a test print

To make sure that you have correctly prepared your printer for printing, we suggest that you perform a test print.

Note: If you are using anything other than the included paper and film roll, you must first change the dip switch settings. Refer to Chapter 4 Troubleshooting for details.

Note: You should use recommended paper for this test to get the best results.

1. While pressing the **Ready** button on the control panel, which is located on the front of the printer, turn the power switch to the ON [I] position.
2. Release the **Ready** button when printing starts. The test will print one page of color patterns.

If the print is successful, you are ready to connect the printer to your computer. If there is any problem in printing, perform all of the **Steps** again.

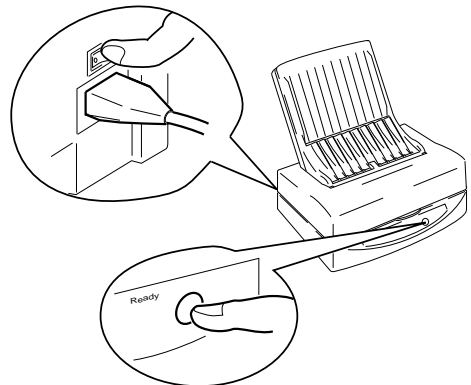

Connecting the printer to your computer

Follow these **Steps** to connect the printer to a computer with a high quality 36 pin shielded Centronics parallel interface cable (not supplied).

Steps:

1. Make certain that both your printer and your computer are turned OFF.

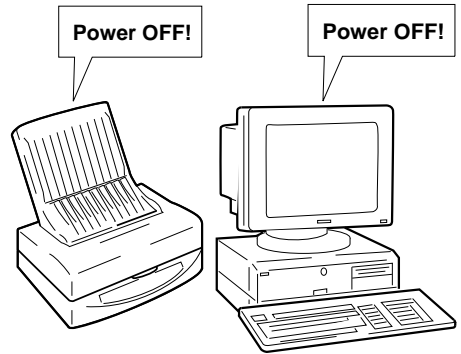

2. Plug one end of the parallel cable into one of the interface ports on the computer.
3. Plug the other end of the interface cable into the printer's interface port which is located on the back of the printer.

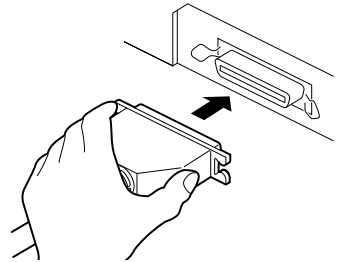

4. Securely fit the prongs on either side of the printer's port into the clips on both sides of the printer cable.

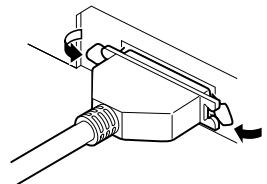

Note:

To ensure proper operation, you must use a high quality Centronics-compatible shielded parallel interface cable. This cable should not be longer than 2 meters or 6 feet.

Chapter 2 Installing the printer driver and TrueType fonts

If you have prepared your printer, you can install the printer driver which accompanied this printer on floppy disk number one. This printer comes with two floppy diskettes. One disk contains the printer driver and the other contains the 35 scalable TrueType fonts which are designed especially for Windows version 3.1 applications printing. To operate the printer, you must follow these steps to install the printer driver software. Before installing the printer driver, however, we suggest that you take a few moments to check your system configuration to make sure that your computer is ready for the installation.

System requirements

To run this printer driver you need an IBM compatible PC with at least a 386SX 16-MHz CPU and you must be running MS-DOS 3.3 or later and Windows 3.1 or later. The WinType 800C will not work properly on 286 based PCs and other earlier systems.

This printer requires at least 8 megabytes (MB) of memory (RAM) and the system software requires at least 5 megabytes of disk space on your system's hard drive. An additional 1.85 megabytes is needed to install all of the 35 TrueType fonts.

A Microsoft-compatible mouse is also highly recommended. This manual assumes that you are using a mouse. If you are not using a mouse, please refer to your Windows 3.1 Users Guide for information on using the keyboard in place of a mouse.

A standard PC parallel printer port is required to connect the printer using a high quality Centronics compatible shielded printer cable.

Note: It is important that you use a properly manufactured cable. A poor quality cable may affect the output of this printer.

Installing the printer driver and TrueType fonts

If at any time during installation of the printer driver you need help, press <F1> or choose <Help> on the **Setup** screen.

Note: Remember that you need at least 5 megabytes of hard disk space to install this printer driver and 1.85 megabytes of hard disk space to install the 35 TrueType fonts. Always make a backup copy of each disk in the software package and store the original disks in a safe place. Use the backup copies to install the software.

Steps:

1. Make sure your printer is connected to a printer port and that it is turned ON.

2. Insert disk #1 into the <A> drive.
(Use the drive depending on your computer.)
3. In the Windows **Program Manager**, choose **Run** from the file menu.



4. In the Command Line box, type "A:\setup" and press <Return>, if A: is the letter of the drive containing the software program. You can also select this by clicking on the **Browse...** button and selecting the drive in which the software program floppy is located. Select **setup.EXE** and click OK.

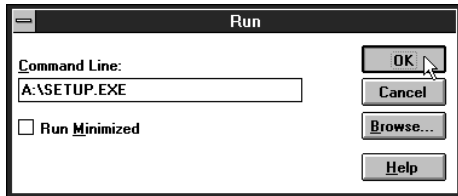

5. You will see the **STAR WinType 800C** installer screen prompting you to select the printer type. You can select either **WinType 800C (A4)** or **WinType 800C (Letter)**. Select one and click on **OK**.

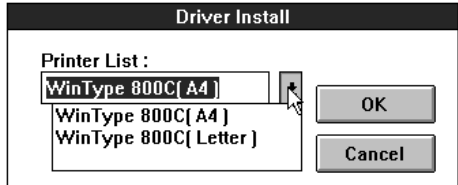

6. After selecting one and clicking **OK**, the **Install Fonts** dialog box will appear. You can install the 35 TrueType fonts at this time by clicking on the **Install Fonts** checkbox.

You can select either **Automatic Install**, which will automatically install all of the fonts on floppy disk #2; or **Custom Install**, which will install only the fonts you select.

You can also decline from adding the TrueType fonts at this time by simply clicking **OK** without selecting **Install Fonts**.

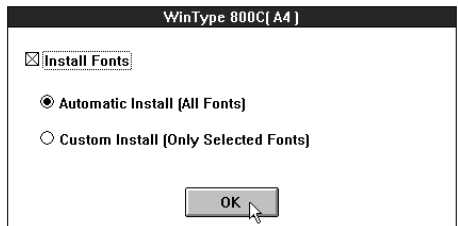

Automatic Install

1. If you selected **Automatic Install**, (**All Fonts**) at **Step 6** on page 12, the install program will prompt you to insert Floppy disk #2, and will automatically proceed with installing all 35 TrueType fonts before requesting you to select a default printer.
2. When the TrueType fonts have been installed, you will be prompted to select a default printer. The install program will automatically open up the **Printer's** dialog box in the **Control Panels**.
3. Double-click on **STAR WinType 800C on LPT1**: if the printer port you are using is **LPT1**. If your computer has only 1 parallel port, **LPT1** is the name of the port.
4. Click **Close** to continue.

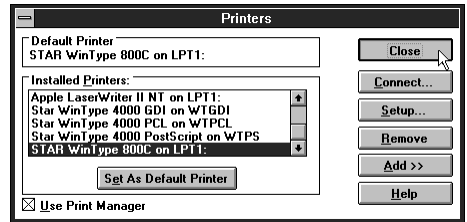

5. When the installation is done, you will see a message telling you that the installation of the printer driver was completed successfully. Click on **Restart** to restart Windows or **Quit**.

Custom Install

1. If you selected **Custom Install**, the install program will prompt you to insert Floppy disk #2 and will open up the **Fonts** icon in the **Control Panel**.
2. Click on the **<Add>** button.
3. Select the appropriate drive (**a:** or **b:**) (Drives list box) for the fonts on disk #2. The fonts will appear in the **List of Fonts** box.
4. Select the fonts you want to add by clicking on their names. To select all of the fonts, click the **Select All** button.

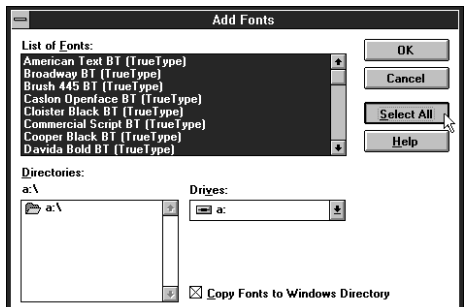
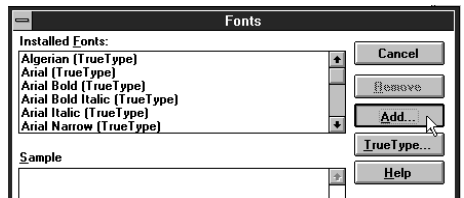

- Click on **OK**. The **Fonts** dialog box will appear. When installation is complete, the fonts will appear in the **Installed Fonts** list box.

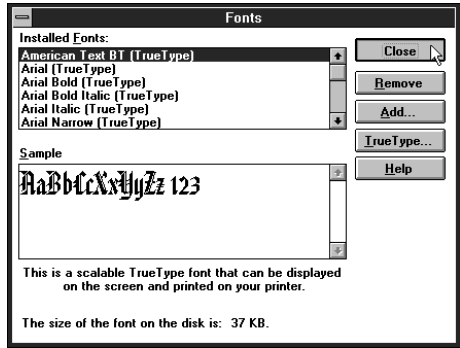

- After clicking **Close**, the printer driver install program will prompt you to select a default printer. You can then proceed with **Automatic Install Steps 3 – 5** described on the previous page.

Without Install Font

- If you didn't select to install any fonts, you will be prompted to select a default printer. You can then proceed with **Automatic Install Steps 3 – 5** described on the previous page.



Note: To make the typefaces appear in your application, reselect your printer in **Printer Setup** in the application **File** menu.

Note: You must restart Windows in order to begin using this printer for the first time.

TrueType font samples

American text	Broadway	Brush 445
Caslon Openface	Cloister Blk	Commercial Script
Cooper Black	Davida BD	DomCasual
EngraversRoman	Exotic350DMBd	Freeform721 Blk
Freehand 521	HandelGothic	Hobo
Humanist 521 XBd	Impress	Kaufmann
OCR-A	Oldreadful No. 7	Onyx
Orbit	Parisian	Park Avenue
Playbill	PTBarnum	Raleigh DMBd
Shadow BlkCn	Seagull Hv	Shotgun
Tango	University Roman	VAGRounded
Vineta	Windsor	

Chapter 3 Printing with WinType 800C

The WinType 800C prints exceptionally vivid and glossy color presentation materials on genuine Star supplies including our coated paper, presentation grade paper, overhead projection (OHP) film and iron-on transfer sheets. The WinType 800C accepts media from the paper tray or you can load media manually. This printer is also easy to use because it works within the graphical interface of the Windows environment. In this chapter, we'll explain the special features of this printer and how to control it to get the best possible printing quality.

The control panel

The control panel on the front of the printer has three lamps and one button. The lamps and button indicate the status of the printer when the power is turned ON.

The Paper lamp

This *orange* colored lamp is ordinarily not lit. If an error is detected, such as "*paper out*" or "*paper jam*," this lamp will flash and the printer will enter the **Not Ready** mode. The **Not Ready** mode is indicated by the flashing, *green* **Ready** lamp.

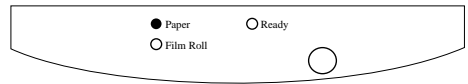

The Film Roll lamp

This lamp is also colored *orange* and it too is ordinarily not lit. If an error is detected, such as "*no film roll*," or "*wrong film roll*" this lamp will flash and the printer will enter the **Not Ready** mode which is also indicated by the flashing *green* **Ready** lamp.

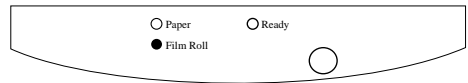

The Ready lamp

This lamp is *green* and will light when you turn on the printer's power. When it is lit, the printer is in the **Ready** mode, which means that it can receive and print data sent from your computer. When an error is detected, the printer will automatically enter the **Not Ready** mode. After you have cleared the problem, press the round **Ready** button. The **Ready** lamp will light and printing can proceed.

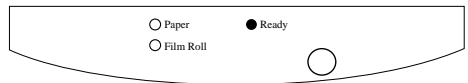

The Ready button

Press this button to set the printer On or Off line with the computer. When On line, or the **Ready** mode, the printer can receive and print data from the computer.

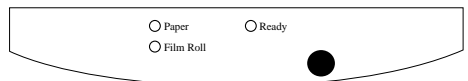

Features of the printer

This printer includes the following capabilities.

- Printing from any Windows 3.1 application
- Full color and monochrome laser quality printing
- 300 dpi for high quality output
- 50 sheet paper tray or manual insertion
- Printing on coated paper presentation grade paper, overhead projection (OHP) film and iron-transfer sheets
- Easy to use graphical interface for the Windows environment
- Small, compact size and stylish design
- 1 page per minute color printing speed
- 2 pages per minute monochrome printing speed

Recommended print media

This printer can print on media ranging from coated paper to presentation grade paper, overhead projection (OHP) film and iron-on transfer sheets. The WinType 800C also accepts media loaded from the paper tray or manually loaded media. The following list describes media to use with this printer to maintain its exceptional color quality.

Media Type	Dimensions	Recommended Type
Coated paper	Letter (8 1/2" x 11") (216mm x 279mm)	A-PWC
	A4 (8.27" x 11.69") (210mm x 297mm)	A4-PWC
	SA4 (8.27" x 14") (210 x 356 mm)	SA4-PWC Manual insertion only.
	Legal (8 1/2" x 14") (216mm x 356mm)	SA-PWC Manual insertion only.
Presentation grade paper	Letter (8 1/2" x 11") (216mm x 279mm)	A-PW
	A4 (8.27" x 11.69") (210mm x 297mm)	A4-PW
	SA4 (8.27" x 14") (210 x 356 mm)	SA4-PW Manual insertion only.
	Legal (8 1/2" x 14") (216mm x 356mm)	SA-PW Manual insertion only.
Iron-on transfer sheets	A4 (8.27" x 11.69") (210mm x 297mm)	T90IO-A4 Manual insertion only
	Letter (8 1/2" x 11") (216mm x 280mm)	T90IO-LTR Manual insertion only
OHP film	Letter (8 1/2" x 11") (216mm x 279mm)	A-TFC
	A4 (8.27" x 11.69") (210mm x 297mm)	A4-TFC
	SA4 (8.27" x 14") (210 x 356 mm)	SA4-TFC Manual insertion only.
	Legal (8 1/2" x 14") (216mm x 356mm)	SA-TFC Manual insertion only.

Operating the printer

Turning ON the power to the printer

Flip the switch located above the power cord on the back side of the printer in the direction of arrow in the illustration at the right. The switch should be in the [|] position.

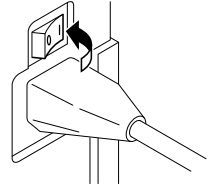

Turning OFF the power to the printer

Flip the same switch on the back side of the printer in the direction of arrow in the illustration at the right. The switch should be in the [O] position.

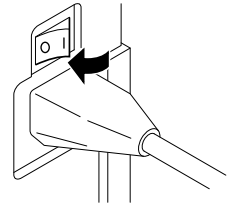

Caution: Never turn OFF the power when you are printing because this will cause paper to jam inside of the machine. See Chapter 4 Maintenance and troubleshooting for an explanation on clearing paper jams.

Loading print media

You can load print media either via the paper tray or manually.

Caution: There are print media types which the paper tray cannot use. They are: Iron-on transfer sheets (all sizes); Legal, Special A4 size (all print media types). See Page 37 for details on printing on iron-on transfer sheets.

The paper tray

The paper tray is for use with A4 and letter sized paper and OHP film only.

Steps:

1. Gently lift up the paper tray cover.

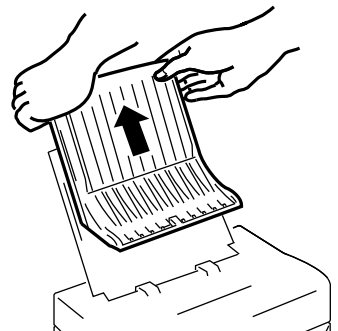

2. Fan approximately 50 sheets of coated/presentation grade paper. This will help prevent paper jams from occurring.

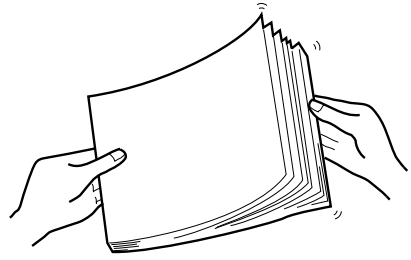

Note: It is best to insert one sheet of media first and make sure that is all the way into the printer before adding more media. When printing with OHP film, insert one sheet of coated/presentation grade paper at the bottom and place the OHP film on top of it.

3. Place the media into the paper tray with the printing side facing the paper tray.

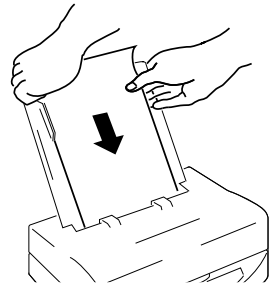

Note: The paper tray can hold up to 50 sheets of coated/presentation grade paper at one time. Be certain to insert the print media with the print side facing down when inserting into the printer.

Note: Recommended coated paper will have the words "PRINT OPPOSITE SIDE" printed in light blue letters on the back side. The side from where you can read the silver colored letters on the Recommended OHP film is the print side.

4. Replace the paper tray cover.

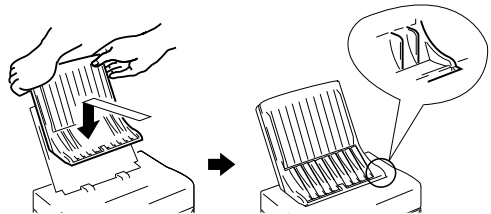

Note: You can print on overhead projection (OHP) film in the same way as described above. However, you must select "**Film**" in the printer driver Media Type box. Read "**Getting ready to print**" on the next few pages for an explanation on setting up the printer driver.

Manual loading

This printer can also receive manually loaded print media. The steps required for manually loading media are outlined below.

Steps:

1. Remove any media that has finished printing.
2. Load the media with the printing side down into the opening in the paper tray cover. Make sure that it is inserted completely into the printer feeder.

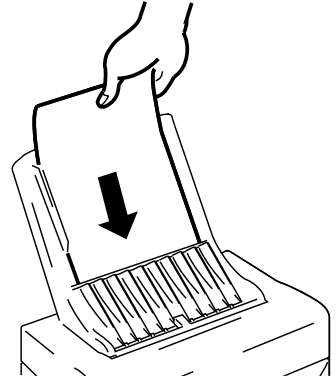

Caution: Do not manually load more than one sheet of media at a time. Wait until the first sheet has been completely printed and removed before loading more media.

Printable area

Refer to the following information to determine the actual printable area for your print media. An illustration of these dimensions is on the next page.

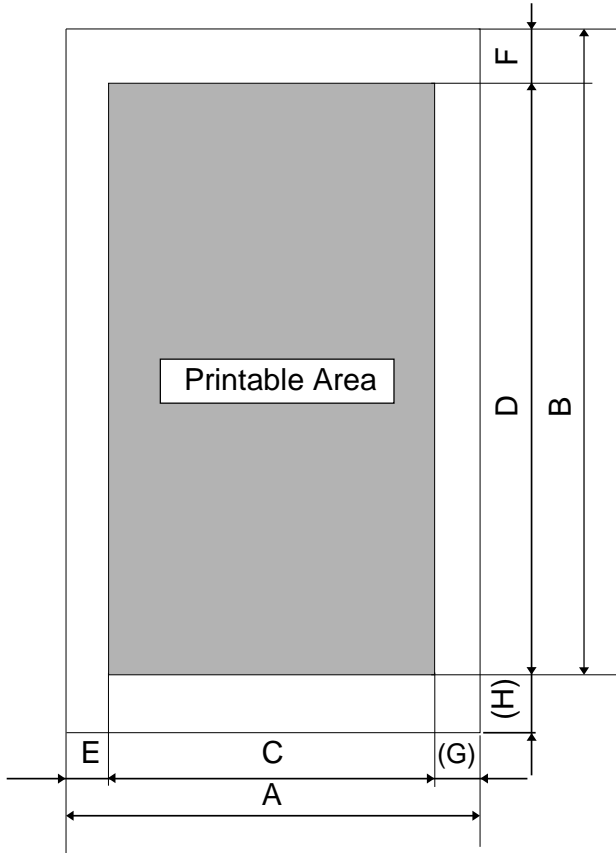

	Letter Size (inches)		A4 Size (mm)		Legal Size (inches)		Special A4 Size (mm)		
	Color	Mono	Color	Mono	Color	Mono	Color	Mono	
A	8.5	8.5	210	210	8.5	8.5	210	210	
B	11	11	297	297	14	14	355.6	355.6	
C	8.1	8.1	200.5	200.5	8.1	8.1	200.5	200.5	
(Dots)	(2432)	(2432)	(2368)	(2368)	(2432)	(2432)	(2368)	(2368)	
D	9.5	10.1	258	273.6	12.5	13.1	316.6	332.1	
(Lines)	(2850)	(3034)	(3048)	(3232)	(3750)	(3934)	(3739)	(3293)	
E	0.2	0.2	4.75	4.75	0.2	0.2	4.75	4.75	
F	0.55	0.55	14	14	0.55	0.55	14	14	
(G)	(0.2)	(0.2)	(4.75)	(4.75)	(0.2)	(0.2)	(4.75)	(4.75)	
(H)	(0.95)	(0.35)	(25)	(9.4)	(0.95)	(0.35)	(25)	(9.5)	
Tolerance	A, B, C	±0.06	±0.06	±1	±1	±0.06	±0.06	±1	±1
	D, E, F	±0.12	±0.12	±3	±3	±0.14	±0.14	±3.6	±3.6

Getting ready to print

Before printing, there are a few things that you should do to setup the WinType 800C for printing. You will need to select the WinType 800C printer driver and make selections on media size, media type, orientation, etc. The **Steps** required for making these selections are outlined below.

Steps:

1. In the **Program Manager**, open the **Main** group by double-click on its icon.
2. Double-click on the **Control Panel** icon in the **Main** group.
3. Double-click on the **Printers** icon in the **Control Panel** window.

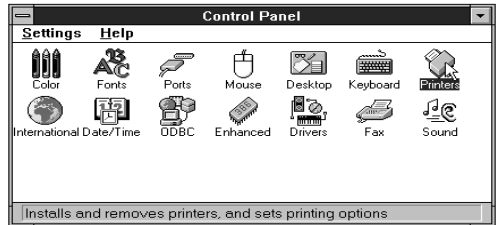

4. Double-click on **STAR WinType 800C on LPT1** in the Installed Printers window, if LPT1 is the port to which this printer is connected. This will set it as the default printer.

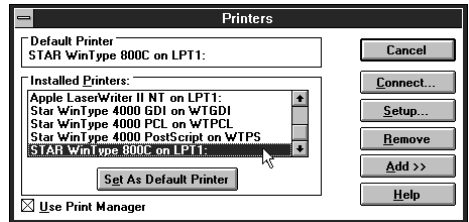

5. Click on the **Setup** button.
6. Select the size of the media you will be using. If you selected A4 type at step #5 on page 10, you can select either **A4 210 x 297 mm (8.27" x 11.69")** or **Special A4 210 x 356 mm (8.27" x 14")**

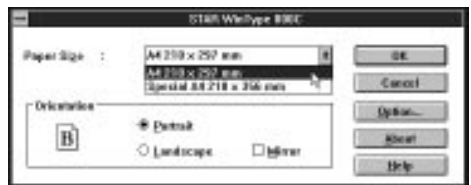

If you selected **Letter** type at step #5 on page 10, you can select either Letter 210mm x 279mm (8 1/2" x 11") or Legal 216mm x 356mm (8 1/2" x 14")

You can also use these to select size corresponding to your overhead projection (OHP) film and iron-on transfer sheets.

7. Select either **Portrait**, **Landscape** or **Mirror** printing.

If you select **Portrait**, your documents will be printed vertically. If you select **Landscape**, your documents will be printed horizontally. **Mirror** is used to reverse the image .



8. Click on the **Options** button. This will call up the **Options** menu where you can make further changes there.
9. Select the media type you want to use in the drop-down list box. Selections include: **Coated Paper**, **Plain Paper** and **OHP Film**. Default is **Coated Paper**.



Note: Select **Coated Paper** when printing presentation grade paper. Select **OHP Film** when printing iron-on transfer sheets.

Caution: You can use print media other than the recommended paper, such as PPC paper or the equivalent. However, be aware that print quality will greatly decrease with other print media. When using PPC paper or the equivalent, select **Plain Paper** in the **Media Type** checkbox.

10. Select the type of film roll you have installed on the printer, from the drop-down list box. Selections include: **3-Color** for 3 color film rolls; **4-Color** for 4 color film rolls; **Monochrome** for black film rolls.



11. Click on the **OK** button of the **Options** dialog box.
12. Click on the **OK** button of the **Setup** dialog box.
13. Click on the **Close** button in the **Printers** dialog box to save your changes and return to the **Program Manager**.

Note: The instructions above are for settings made from the **Control Panel**. Depending on the application software you are using, similar settings can be made from the "**Print Setup**" command in the **File** menu.

Printing

When you select the **Print** command from the **File** menu of your Windows application, printing will begin. Operation may vary somewhat, however, per software application program.

If you have selected **Fast Print to Port** (see "High speed printing" on page 26) in the **Options** dialog box, a message like the one at the right will be displayed. This will provide you with the status of the document being currently printed.

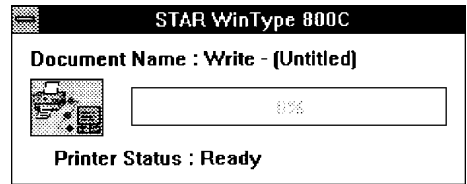

DIP switch settings

This printer is equipped with DIP switches so that you can freely set the darkness or lightness of the final print. The DIP switches are located on the back side of the printer and can be changed using the tip of a ball point pen or other similar object. Altogether there are 7 levels from which you can select.

To change the darkness setting of your printer, you use DIP switches 7, 8 and 9. Use the following illustration to make your selections.



Note: Printer driver settings have a higher priority than DIP switch settings. DIP switch settings are primarily useful for test prints.



Caution: DIP switches other than the ones mentioned here should not be touched.

Caution: Always turn OFF the power when making DIP switch setting changes.

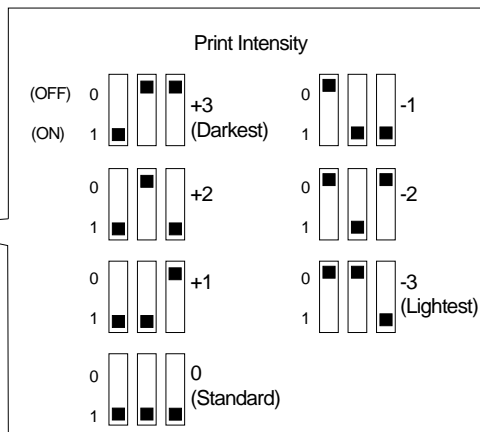
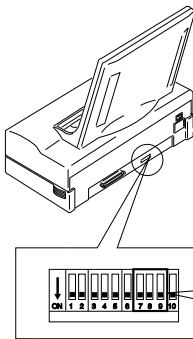

Note: The default setting is 0 (all switches ON).

There are other selections in the **Options** dialog box that can enhance the performance and color graphics quality of your printer. These selections - changing halftones, image quality, gamma correction, color balance and high speed printing - are described in the following sections.

Changing halftones and image quality

The **Options** dialog box, introduced earlier, contains three parameters for changing halftone and image quality. The following explains how to change them and what each setting means.

Changing halftones

Steps:

1. Open the **Main** group by double clicking on its icon.
2. Double-click on the **Control Panel** icon in the **Main** group.

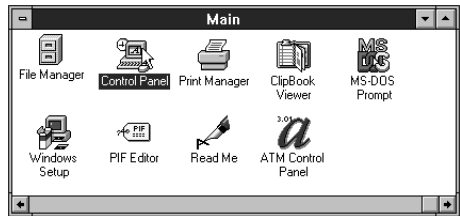

3. Double-click on the **Printers** icon.

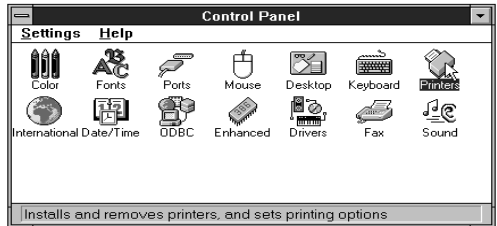

4. Click on **STAR WinType 800C on LPT1** in the **Installed Printers** list, if **LPT1** is the port to which this printer is connected.

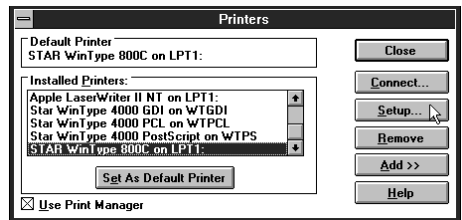

5. Click on the **Setup** button.

6. Click on the **Options** button.

There is a box in the Options dialog box titled "**Halftone**" which is where you can select the halftone that meets your needs. The following lists the meanings of each type of halftone.

Spiral This gives a sharp image and is best for computer graphics and presentations. Because the "cells" for the basic image are smaller, you can print much finer images.

Mesh This also gives a sharp image and is good for computer graphics and presentations. Because the "cells" for the basic image are large, color discrepancies won't stand out.

Error Diffusion This gives a softer image and is good for natural looking images.

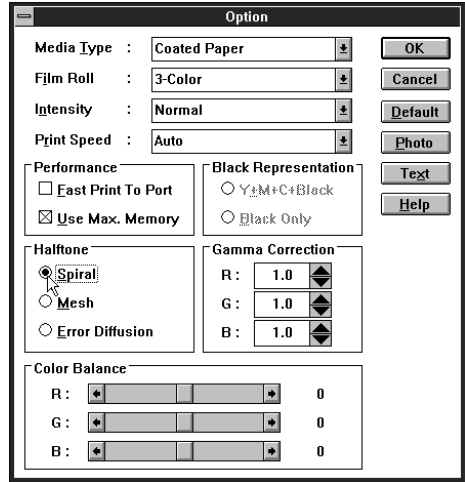

Changing gamma correction

Gamma correction, also part of the **Options** dialog box, is used for adjusting the brightness of tones. This printer driver includes R: (red), G: (green), and B: (blue) gamma corrections. You can brighten or darken halftone colors using these settings. Refer to the illustration below to set gamma correction.

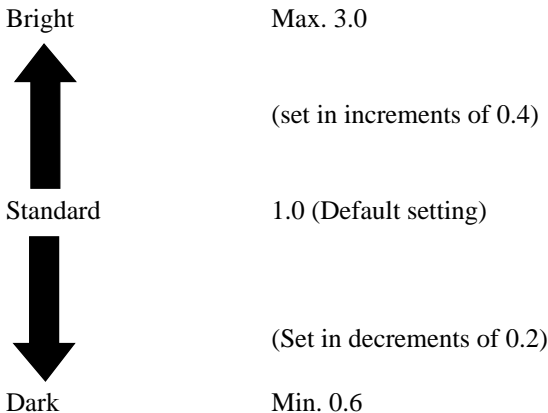

Note: If the gamma correction is set too high, gradations will decrease.

Changing color balance

You can use the **color balance** scroll bars, also part of the **Options** dialog box, to change the balance of the colors you are going to use. Again, this printer driver is equipped with scroll bars for the three colors of red, green and blue. This is good for enhancing some of the colors you want to use in your presentation documents. For example, if you move the R: (red) scroll bar to the right, you can increase the reddishness of the overall image. Use the following illustration to set the density you want.

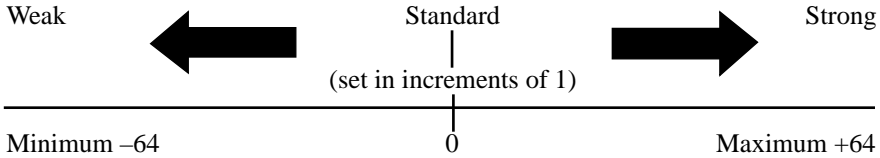

Note: Gamma correction affects the 40% to 60% of the color selected.
Density adjusts the concentration of the entire body of color selected.

7. When you have finished making your changes, click on the **OK** button of the **Options** dialog box.
8. Click on the **OK** button of the **Setup** dialog box.
9. Click on the **Close** button to save your changes and return to the **Program Manager**.

High speed printing

There are two parameters from which you can choose for printing speed. These parameters are under the **Performance** box in the **Options** dialog box. Follow the **Steps** below to change printing speeds.

Steps:

1. Open the **Main** group by double clicking on its icon.
2. Double-click on the **Control Panel** icon in the **Main** group.

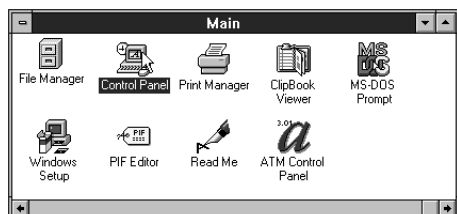

3. Double-click on the **Printers** icon.

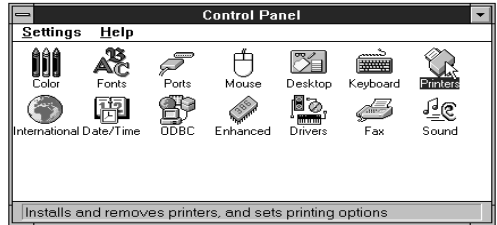

4. Click on **STAR WinType 800C on LPT1** in the **Installed Printers** list, if **LPT1** is the port to which this printer is connected.

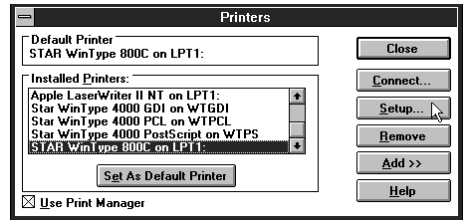

5. Click on the **Setup** button.
6. Click on the **Options** button.
7. Click on **Fast Print to Port**.

Putting an X in the **Fast Print to Port** box will cause your print job to be sent directly to the printer without going through Windows **Print Manager**. This will increase printing speed.

Note: **Fast Print to Port** works only in **386 Enhanced** mode of IBM PC/AT compatible computers.

Note: If you are linked to a network or printing to a file, do not use **Fast Print to Port**.

8. Click on **Use Max. Memory**.

Putting an X in the **Use Max. Memory** box will increase printing speed by increasing the memory (RAM) used to process your print job.

Note: If your application is low on memory, do not use **Use Max. Memory**. If there is not enough memory when this is checked, printing speed will not increase.

Use Max. Memory memory size varies according to the conditions under which it is being used. Please refer to the table on the next page for memory sizes. If **Use Max. Memory** is not being used, memory size is 1MB regardless of the conditions.

Film Roll			
Paper Size	Monochrome	3-color	4-color
A4 or Letter	1MB	3MB	4MB
Special A4 or Legal	1.2MB	3.6MB	5MB

Print speed

Another way you can change the printing speed is by changing the settings in the **Options** menu.

Steps:

1. Open the **Main** group by double clicking on its icon.
2. Double-click on the **Control Panel** icon in the **Main** group.

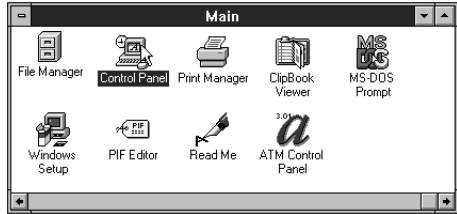

3. Double-click on the **Printers** icon.

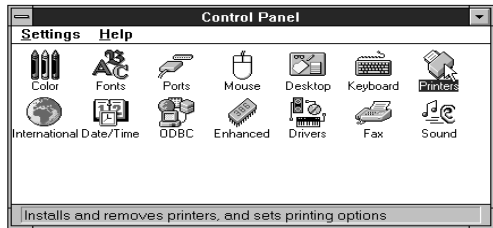

4. Click on **STAR WinType 800C on LPT1** in the **Installed Printers** list, if **LPT1** is the port to which this printer is connected.

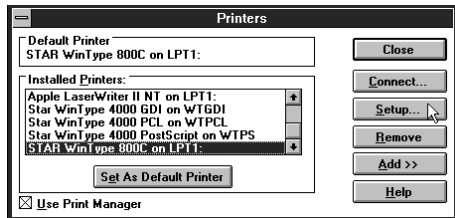

5. Click on the **Setup** button.

6. Click on the **Options** button.

The fourth item from the top in the **Options** dialog box is **Print Speed**. Here you can select between **Auto**, **Medium** and **Low** speeds. An explanation of each is below.

Auto: This is the default setting which prints documents at the standard speed of this printer.

Medium: This is slightly slower than **Auto**.

Low: This is the slowest speed available. It is useful when printing graphics with patterns or high intensity.

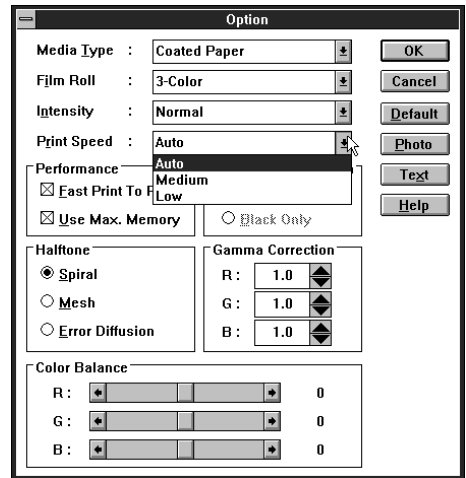

Other buttons in the Options dialog box

Black Representation

This function in the **Options** dialog box is used to produce a sharper black print for your document only when using 4 color film rolls. If you select $Y + M + C = \text{Black}$ your printer will print each of the three colors for your black text or graphics and will place one layer of black ink on top to give you a sharper, more solid black.

You can also select **Black Only** which will cause the film roll to bypass the other three colors and print only black where black is required.

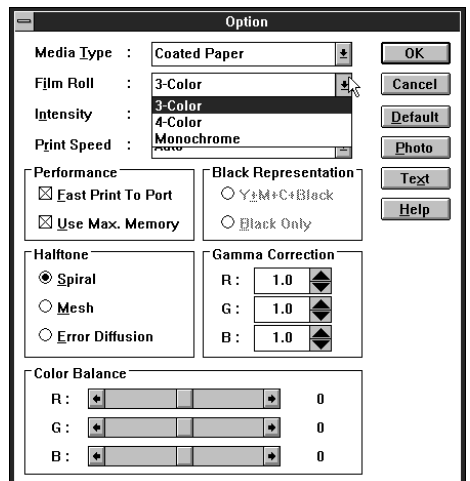

Intensity

This will change the lightness and darkness of the printed image.

The 'Option' dialog box is shown with the following settings:

- Media Type: Coated Paper
- Film Roll: 3-Color
- Intensity: Normal
- Print Speed: +3, +2, +1, Normal (selected), -1, -2, -3
- Performance: East Print To Port, Use Max. Memory
- Halftone: Spiral, Mesh, Error Diffusion
- Gamma Correction: R: 1.0, G: 1.0, B: 1.0
- Color Balance: R: 0, G: 0, B: 0

Buttons on the right: OK, Cancel, Default, Photo, Text, Help.

Photo

When you click on the **Photo** button, Gamma Correction will automatically change to the values of R = 0.8, G = 1.0 and B = 1.4 to give your photographs more true color printing. Color Balance will be set to R = 0, G = 5 and B = 0

If you click on this when using 4 color film ribbons, **Black Representation** will be set to **Y+M+C+Black**.

The 'Option' dialog box is shown with the following settings:

- Media Type: Coated Paper
- Film Roll: 4-Color
- Intensity: Normal
- Print Speed: Auto
- Performance: East Print To Port, Use Max. Memory
- Black Representation: Y+M+C+Black, Black Only
- Halftone: Spiral, Mesh, Error Diffusion
- Gamma Correction: R: 0.8, G: 1.0, B: 1.4
- Color Balance: R: 0, G: 5, B: 0

Buttons on the right: OK, Cancel, Default, Photo, Text, Help.

Text

When you click on the **Text** button, Gamma Correction will automatically be set to the values of R = G = B = 1.0 and Color Balance will be set to R = G = B = 0.

If you click on this when using 4 color film ribbons, **Black Representation** will be set to **Black Only**.

The 'Option' dialog box is shown with the following settings:

- Media Type: Coated Paper
- Film Roll: 4-Color
- Intensity: Normal
- Print Speed: Auto
- Performance: East Print To Port, Use Max. Memory
- Black Representation: Y+M+C+Black, Black Only
- Halftone: Spiral, Mesh, Error Diffusion
- Gamma Correction: R: 1.0, G: 1.0, B: 1.0
- Color Balance: R: 0, G: 0, B: 0

Buttons on the right: OK, Cancel, Default, Photo, Text, Help.

Printing on Special A4 and Legal size media

This printer can also print on special A4 size media (210 x 356mm/8.27 in. x 14 in.) and Legal (8 1/2" x 14"). However, you must install the proper Special A4/Legal size film roll and setup the new paper size through the **Printers Setup** dialog box in Windows.

Steps:

1. Open the **Main** group by double clicking on its icon.

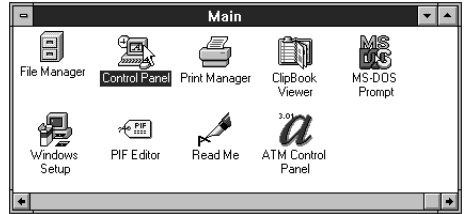

2. Double-click on the **Control Panel** icon in the **Main** group.

3. Double-click on the **Printers** icon.

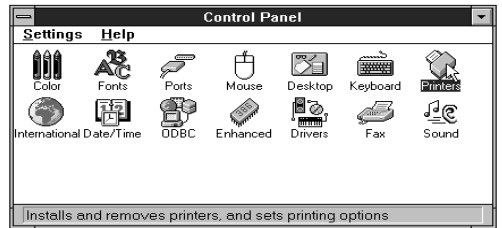

4. Click on **STAR WinType 800C on LPT1** in the **Installed Printers** list, if **LPT1** is the port to which this printer is connected.

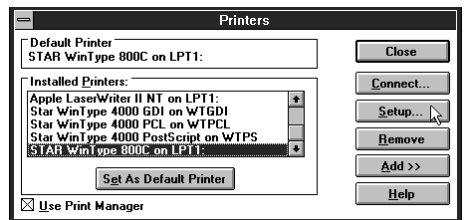

5. Click on the **Setup** button.

- Click on the Drop-down list box to reveal media sizes.
- Click on **Legal 8.5 x 14 in.** When using Letter type, A4 will become Special A4.

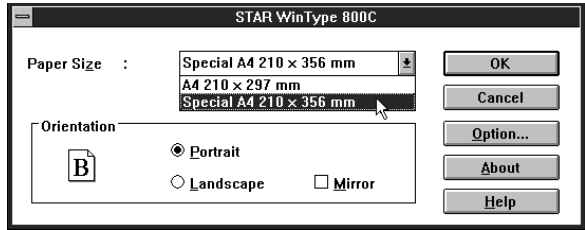

- Click on the **OK** button.
- Click on the **Close** button to save your settings and return to the **Program Manager**.
- You must manually feed Legal print media for printing. This is because the paper tray does not automatically feed SA4 media.

Note: You must install the proper TL-1-14C3H (3 color), TL-1-14C4H (4 color) film roll to be able to print. Failing to do so will result in a printing error. See "Installing the film roll" on page 5 for details on installation.

Note: See "Manual loading" on page 19 for details on manually feeding print media.

Replacing the film roll

You must replace the film roll whenever you change from color to monochrome printing (or the reverse) or whenever the film roll is used up. Follow the **Steps** below to replace the film roll.

Steps:

1. Make sure that the power switch is in the OFF position.

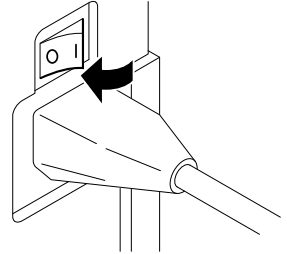

2. Open the top cover of the printer while the paper tray is in place. Use the Top Cover Support bar to prop up the Top Cover.

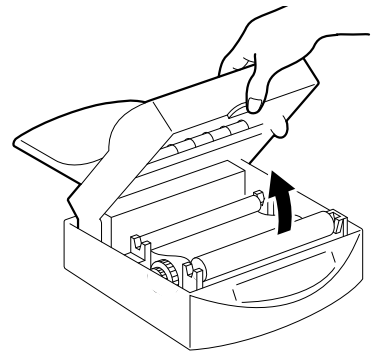

Caution: Always use the **Top Cover Support Bar** to prop open the Top Cover.

Caution: Always leave the paper tray in place when opening the printer's top cover. Removing it while the top cover is open will cause it to fall shut while your hands are inside the machine.

Caution: Do not touch the sensor located at the front left side inside the printer when the printer's power is ON. Touching the sensor will cause the gears to automatically rotate.

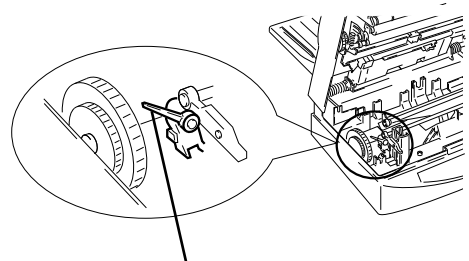

Do not touch this sensor

3. Remove the film roll.
First remove the take-up roll located in the front of the printer.

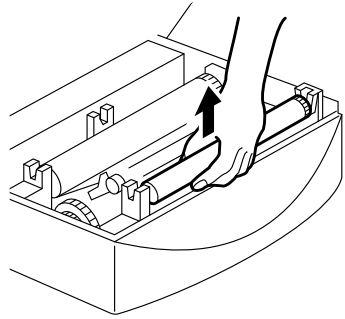

Next, remove the film roll in the back of the printer.

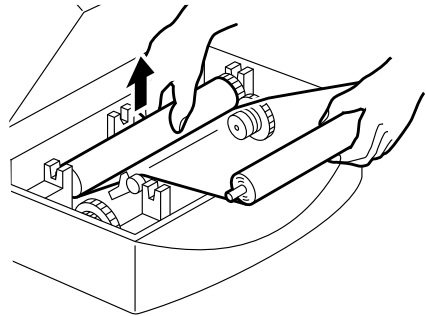

Caution: Be careful not to touch the thermal print head because it may be very hot.

4. Remove the film roll bobbins from the roll you just removed.

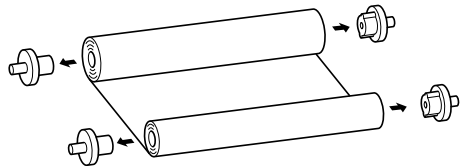

Note: You can dispose of used film rolls as normal garbage. However, you should remember that all printed data will remain in reverse image on the film roll. Take special precaution if you have printed sensitive information using the film roll.

5. Follow the instructions on pages 4 - 6 to install a new film roll.

Changing the film roll setting

You must setup the printer driver in Windows when changing to a different type of film roll. Follow the **Steps** below.

Steps:

1. Open the **Main** group by double clicking on its icon.
2. Double-click on the **Control Panel** icon in the **Main** group.

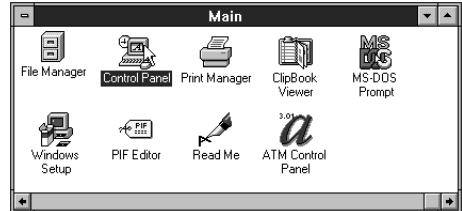

3. Double-click on the **Printers** icon.

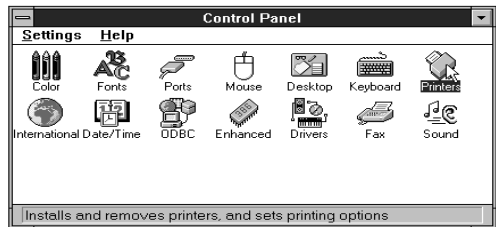

4. Click on **STAR WinType 800C on LPT1** in the **Installed Printers** list, if **LPT1** is the port to which this printer is connected.
5. Click on the **Setup** button.
6. Click on the **Options** button.

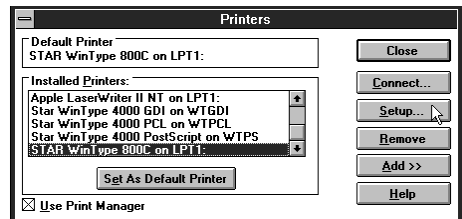

7. Click on the **Film Roll** Drop-down list box and select the new type of film roll you have just installed.

See page 2 of Chapter 1 "Setting up your printer" for a list of genuine Star printer supplies for a description of the types of film rolls you can use with this printer.

8. When finished making your selection, click on the **OK** button.
9. A message to confirm your changes will appear. Click on **OK**.

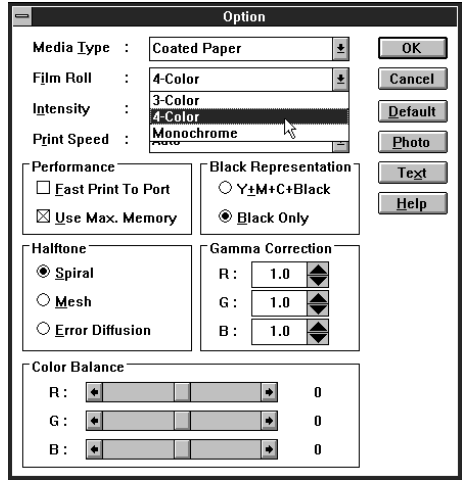

10. Click on the **OK** button of the **Setup** dialog box.
11. Click on the **Close** button to save your changes and return to the **Program Manager**.

Printing with iron-on transfer

This printer can print not only on coated paper for laser quality color output, but it also can output laser quality color images on iron-on transfer sheets. However, you should observe the **Steps** below when printing on iron-on transfer sheets.

Note: Use only Genuine Star Iron-on Transfer Sheets for this application.

The iron-on transfer is a great way to create original designs for T-shirts or other cloth items. When you are printing iron-on transfer sheets, always select **OHP Film** in the **Media Type** setting of the printer driver.

Steps for printing on the transfer sheets

1. Create an image with your software program.
2. Place the finishing sheet, **with its silicon side facing upwards** into the paper tray base. The silicon side is the side facing you when the cut corner is in the upper right hand side.

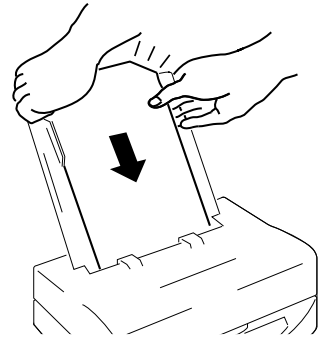

Note: The finishing sheet is not for printing. It is used to prevent any printing or feeding trouble with the iron-on transfer sheet.

3. After inserting the finishing sheet, place the paper tray cover on top of the paper tray base in the direction of the arrows in the illustration at the right.

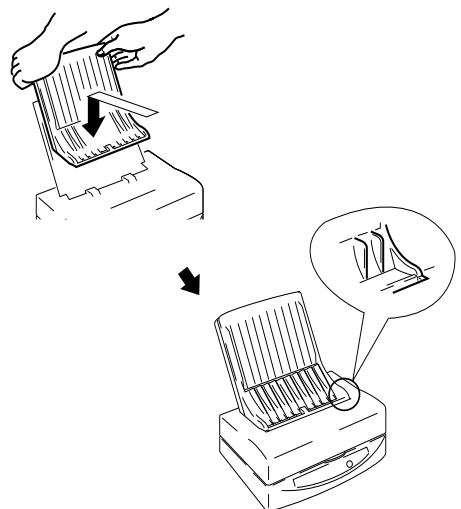

- Click on the **Mirror** checkbox in the **Printers Setup** dialog box. This will cause the printer to print a mirror image of your design.

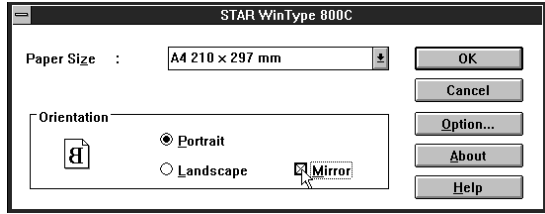

- Load the iron-on transfer sheet, with the printing side down, into the opening in the paper tray cover. Make sure that it is inserted completely into the printer.

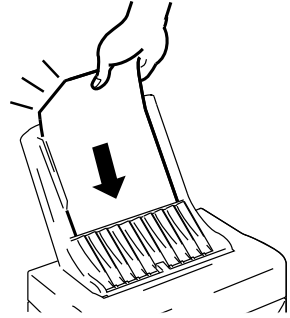

Caution: Do not manually load more than one sheet at a time. Wait until the first sheet has been completely printed before loading more sheets.

- Print your image on the transfer sheet.

Steps for transferring the image on the cloth

- Cut out the image on the transfer sheet leaving approximately 1/2" margin around the image. Round off the corners because this will reduce the chance of the image peeling off.
- Carefully position the transfer sheet on the cloth with the image side down.
- Uniformly iron the transfer sheet with the iron set to 320°F (160°C).
- Slowly remove the transfer sheet from the cloth starting from a corner.

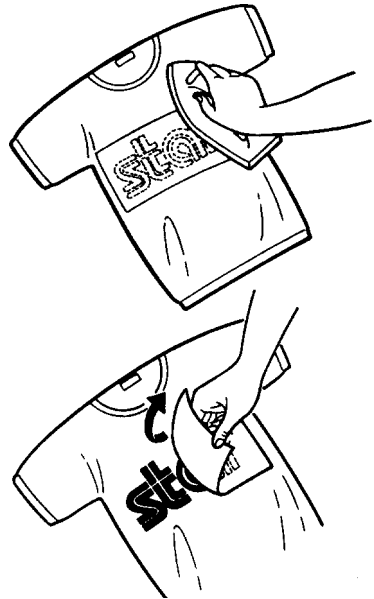

Note: Do not remove the transfer sheet until it has cooled to room temperature.

Steps for the finishing process

1. Place the finishing sheet over the image on the cloth, with the cut out corner in the top left. Make sure that the silicon side is down. The finishing sheet should completely cover the image.
2. Iron the finishing sheet at the same setting used to iron the transfer sheet.



Note: Do not remove the finishing sheet until it has cooled to room temperature.

3. Slowly remove the finishing sheet from the cloth starting from a corner.
4. If the image seems like it will peel off of the cloth, repeat the finishing process.

Chapter 4 Maintenance & troubleshooting —

Your printer is a reliable, precisioned instrument. It was built with care and should, if handled properly, perform at its finest and serve you well for a long time. However, like any piece of equipment, there may be times when it may not perform as you had expected. In this chapter, we would like to provide you with simple guidelines on the proper maintenance that will keep your printer in fine working condition and troubleshooting techniques to help you should you ever experience problems.

Maintaining your printer

The best way to keep your printer in fine working condition is to keep it clean. The following describes how to clean your printer.

Cleaning the outside of the printer

Steps:

1. Use a dry, soft cloth to gently wipe the exterior of the printer.

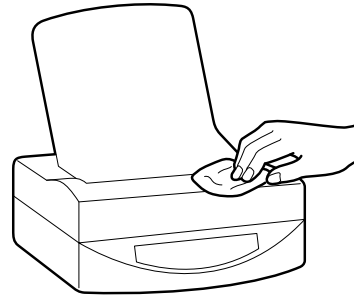

If your printer is exceptionally dirty, you may apply water or a neutral cleaner to the cloth to wipe away the excess dirt.

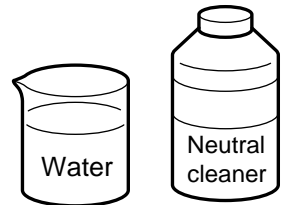

Caution: Do not use thinners or organic solvents, such as Benzine, to clean your printer.

Cleaning the inside of the printer

If you periodically clean the inside of your printer, it will continue to perform at its finest for a long time. You should remember to clean the inside of the printer whenever any of the following occur.

- Paper jams occur often
- Vertical lines occur in the printed image
- Colors are not stable

To clean the inside of the printer, you should prepare the following items.

- A soft cloth dampened with ethanol.

Caution: Gasoline, Benzine and thinners cause irreversible damage to plastic. They should never be used to clean this printer.

Caution: Do not use sharp objects to clean the inside of the printer because this could cause damage.

Steps:

1. Dampen a soft cloth with ethanol.

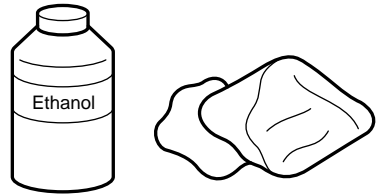

2. Make sure that the printer is not printing and turn off the power to the printer.

3. Remove the paper tray cover and the paper tray.

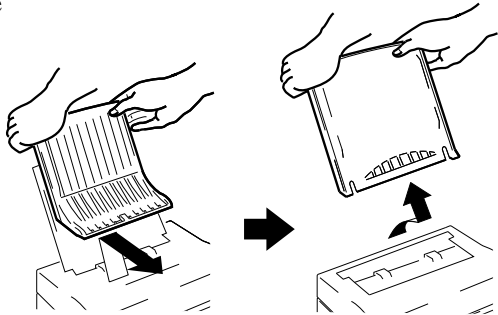

4. Press the top cover release and open the top cover while the paper tray is in place. Use the Top Cover Support Bar to prop up the top cover.

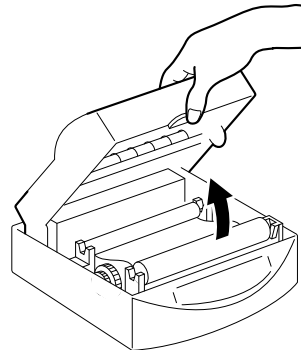

Caution: Always use the **Top Cover Support Bar** to prop open the Top Cover. Removing it while the Top Cover is open will cause it to fall shut while your hands are inside the machine.

Caution: Because cleaning is done while the paper tray cover and paper tray are removed from the printer, it may slam shut.

Always hold the top cover with one hand while cleaning to prevent injury.

5. Remove the film rolls as described on page 28.

6. Wipe the thermal head using the soft cloth.

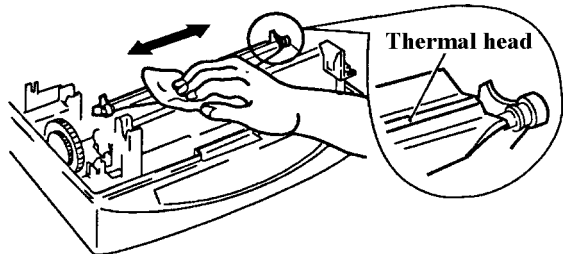

Caution: If you have used the printer recently, be especially careful because the thermal head may still be hot.

7. Gently wipe the platen roller with the soft cloth.

Wipe the entire roller while rotating the gear.

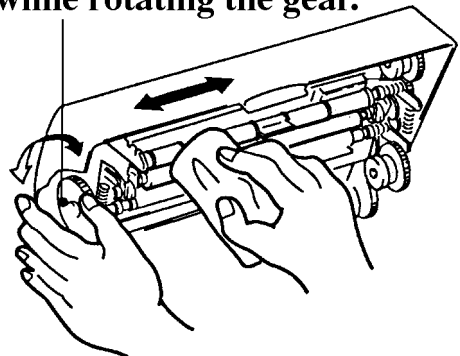

8. Wipe the paper feeders with the soft cloth.

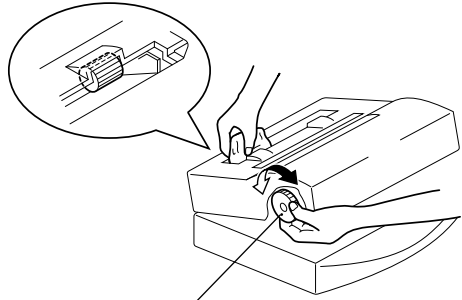

Wipe the entire roller while rotating the gear.

9. Wipe the paper extract rollers with the soft cloth.

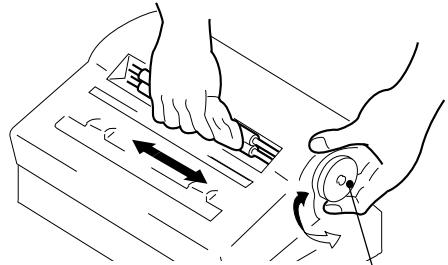

Wipe the entire roller while rotating the gear.

10. While holding up the paper guide, wipe the area of the paper pinch rollers you can see with the soft cloth.

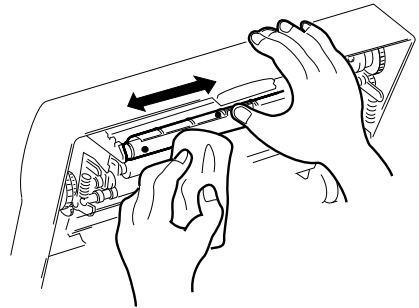

11. Rotate the gear, shown in the illustration, to expose the opposite side of the pinch rollers.

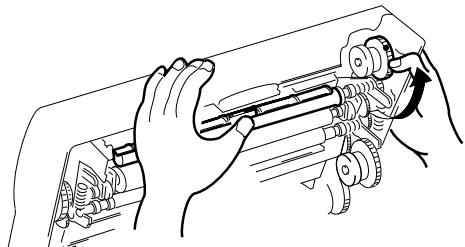

12. Wipe the pinch rollers in the back of the inside of the printer.

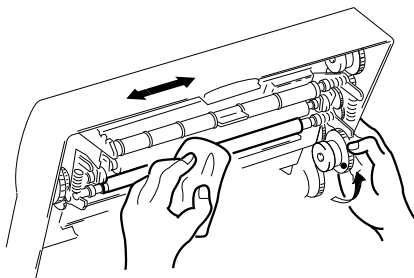

13. Lay the Top Cover Support Bar down to its original position while holding the top cover with one hand and gently close the top cover. You should hear a clicking sound as it closes tightly.

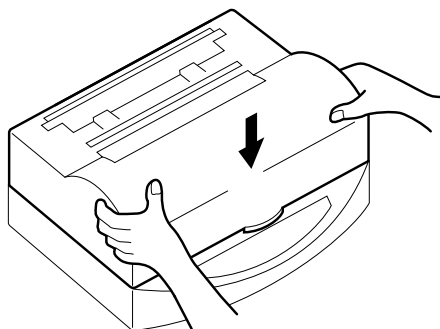

14. Place the paper tray and paper tray cover back into their normal operating positions and turn ON the power to the printer.

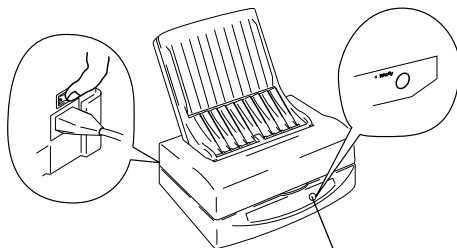

Make sure that the Ready lamp is lit.

Caution: Do not print for 5 to 10 minutes (or until the alcohol has dried) after cleaning the inside of the printer.

Clearing paper jams

If you should experience a paper jam, Windows will display an error message and the **Paper** lamp on the control panel will light. Observe the following steps should a paper jam occur.

Steps:

1. Turn the printer's power OFF once and then turn it ON again.

Note: Turning the printer's power OFF and ON again will initialize the printer which makes removing the jammed paper easier.

2. Turn the power OFF again.
3. If your print media has jammed partway through the feeder mechanism, remove the paper tray cover and gently pull the paper up through the entrance of the feeder.

Proceed to **Step 8** on page 48.

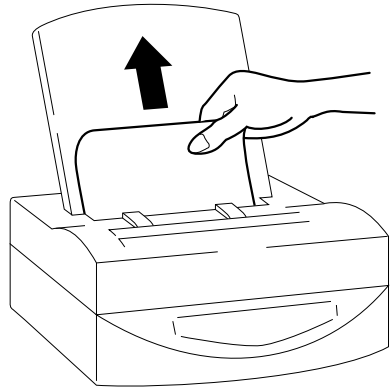

4. If your print media has jammed partway through being ejected from the printer, gently pull the media up through the paper eject. Proceed to **Step 8** on page 48.

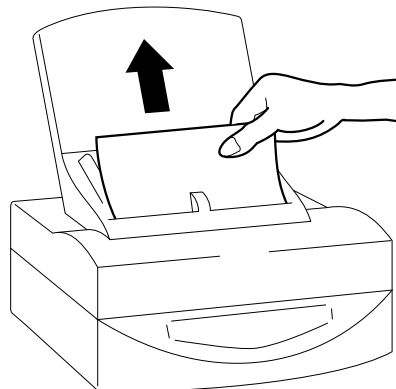

5. If your print media becomes jammed inside of the machine, press the cover release and open the top cover while the paper tray is in place. Use the Top Cover Support Bar to prop up the Top Cover.

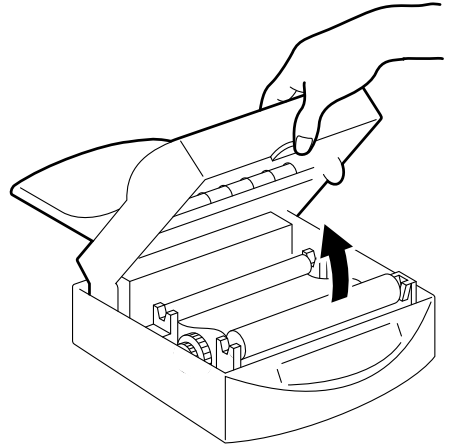

6. Your print media will appear if you gently rotate the gear, as shown in the illustration at the right.

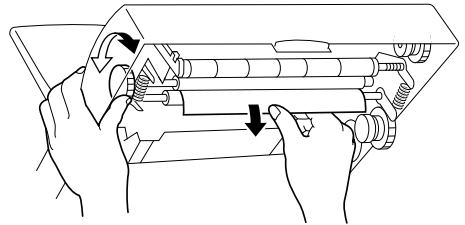

Note: Do not leave any paper scraps inside of the printer if your paper should rip.

7. After removing the jammed paper, close the top cover. You should hear a clicking sound as it closes tightly.

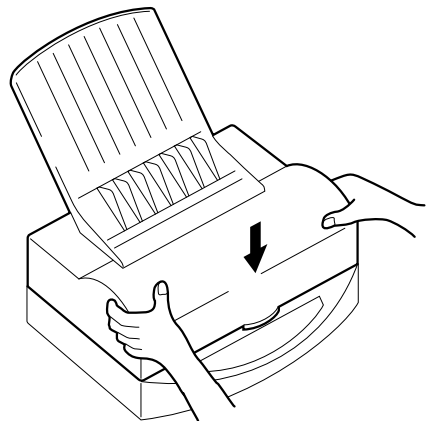

8. Turn ON the power to the printer and confirm that the **Ready** lamp is lit.

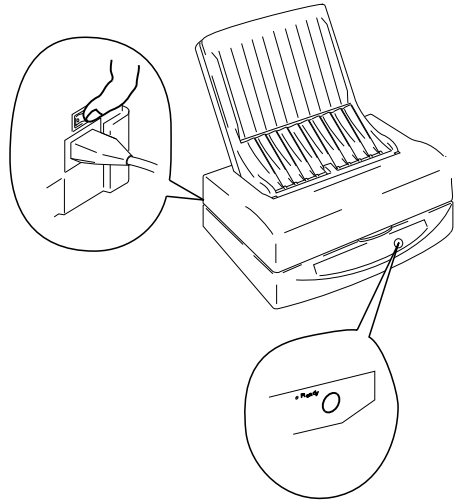

Transporting your printer

We suggest that you take the following precautions when transporting your printer to a new location to prevent damage to it.

Steps:

1. Get the original carton box and protective items out and ready for packing the printer.
2. Make sure that the printer is not printing and turn OFF the power.
3. Unplug the interface cable and the power cord.
4. Press the cover release and open the top cover and use the Top Cover Support Bar to prop open the top cover.

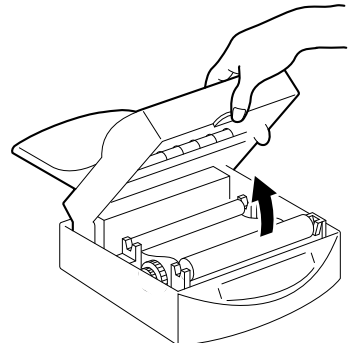

5. Remove the film roll as described on page 33.
6. Replace the protective inserts as shown in the illustration at the right.

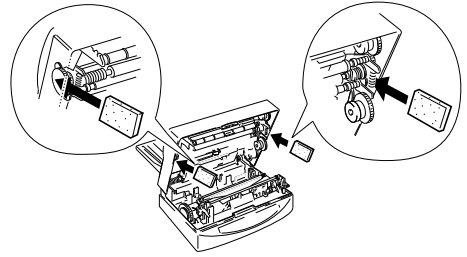

7. Replace the protective sheet.

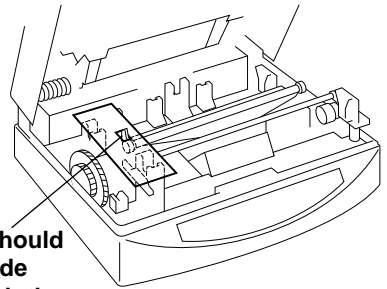

This should protrude through the sheet.

8. Lay the Top Cover Support Bar down to its original position while holding the top cover with one hand.
9. Close the cover completely while gently pressing the protective pieces toward the inside of the printer.

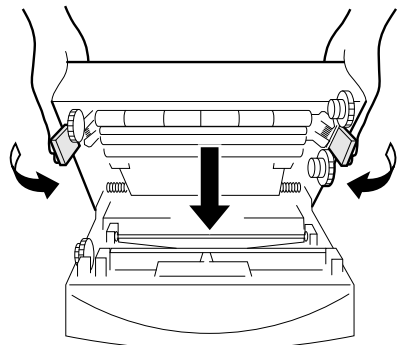

9. Remove the paper tray cover and the paper tray base.

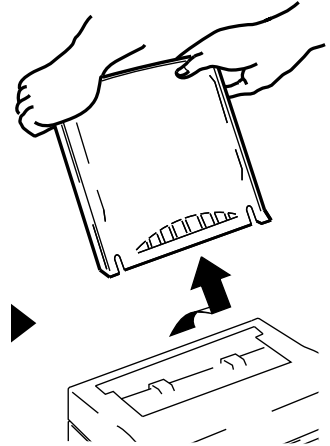
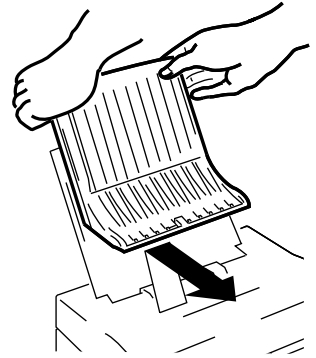

10. Wrap the printer in its original protective sheet and place it in its original box.

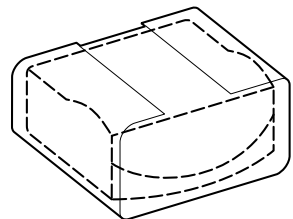
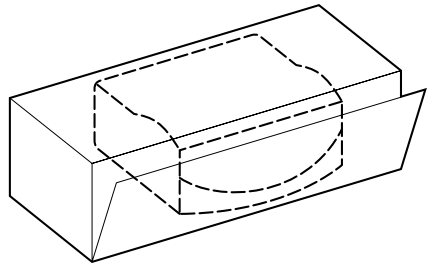

Troubleshooting

Your printer is a reliable, precisioned instrument and should not cause you any trouble if it is used and treated sensibly. However, we are providing you with this troubleshooting section to help you should you encounter any problems with your printer. Remember that your printer is a highly sophisticated device and that this section is intended to be only a brief guide. As with many other precisioned instruments, this printer contains high voltage. We request that you perform only the operations which are explained here.



Warning: Any attempt to perform troubleshooting operations other than those described here may result in electric shock, damage to the printer or both.

The following table is provided to give you an idea of where to find solutions to problems you may encounter.

Region of problem	Description
Power supply	Power is not being supplied to the printer. (Page 52)
Printing	The printer doesn't print, or it stops printing. (Page 52) The printed image has vertical lines. (Page 52) The overall print is light. (Page 52) The overall print is dark. (Page 53) Patterns appear where print density is high. (Page 53) Color variations are too large. (Page 53) Only part of the image is printed. (Page 54)
Paper feeding	Paper won't feed from the paper tray or manually. (Page 54) Paper jams occur frequently. (Page 54) Two sheets of paper are fed at the same time. (Page 54)

Power supply

Power is not being supplied to the printer.

Check	Possible remedy
Is the printer turned ON?	Check to make sure that the power switch on the back of the printer is in the ON [I] position.
Is the AC adapter properly plugged into the printer and the electrical outlet?	Turn the printer OFF. Make sure that the power cable is securely connected and then turn the printer back ON.
Is the voltage correct?	Use only the AC adapter that came with this printer.

Printing

The printer doesn't print, or it stops printing.

Check	Possible remedy
Is the interface cable connected securely?	Make sure that the interface cable is plugged securely.
Is the printer in the Ready mode?	Make sure that the Ready lamp is lit. If it is flashing, press it to enter the Ready mode.
Is paper jammed?	Make sure that there is no paper or other media jammed inside of the printer. See page 46 for an explanation on clearing paper jams.
Is the software you are using properly installed for your printer?	Check the installation settings in your software and re-install it if necessary.
Is the proper media being used?	Special A4 media must be either manually fed or rework your data for A4 size.

The printed image has vertical lines.

Check	Possible remedy
Is the thermal head dirty?	Clean the inside of the printer. See page 41 for an explanation of the proper way to clean the inside of your printer.

The overall print is light.

Check	Possible remedy
Is the media surface too rough?	Use only the recommended media with this printer. See Chapter 3 for an explanation of the proper media to use.

The overall print is light - continued.

Check	Possible remedy
Are you using the correct side?	Recommended coated paper will have the words "PRINT OPPOSITE SIDE" printed in light blue letters on the back side. The side from where you can read the silver colored letters on the recommended OHP film is the print side.
Is the media type set correctly?	Check the media type settings in the Printers Setup dialog box in Windows.
Is the print intensity set too low?	Change the Printer Setup dialog box in Windows to a higher setting. See Chapter 3 Changing intensity for an explanation.

The overall print is dark.

Check	Possible remedy
Is the media type set correctly?	Check the media type settings in the Printers Setup dialog box in Windows.
Is the print intensity set too high?	Change the Printer Setup dialog box in Windows to a higher setting. See Chapter 3 Changing intensity for an explanation.

Patterns appear where print density is high.

Check	Possible remedy
Is the print intensity set too low?	Change the Printer Setup dialog box in Windows to a higher setting. See Chapter 3 Changing intensity for an explanation.
Is the print speed too high?	Change the print speed. See Chapter 3 Changing print speed for an explanation.

Color variations are too large.

Check	Possible remedy
Are the platen and pinch rollers dirty?	Clean the inside of the printer. See page 41 for an explanation of the proper way to clean the inside of your printer.

Only part of the image is printed.

Check	Possible remedy
Is the proper media being used?	Special A4 media must be either manually fed or rework your data for A4 size.

Paper feeding

Paper won't feed from the paper tray or manually.

Check	Possible remedy
Is paper feed roller dirty?	Clean the inside of the printer. See page 41 for an explanation of the proper way to clean the inside of your printer.
Is the paper too thick or too thin?	Use only the recommended paper types.
Is the top cover completely closed?	Close it tightly if it is open.

Paper jams occur frequently.

Check	Possible remedy
Are the platen and pinch rollers dirty?	Clean the inside of the printer. See page 41 for an explanation of the proper way to clean the inside of your printer.
Is the paper too thick or too thin?	Use only the recommended paper types.
Is the top cover completely closed?	Close it tightly if it is open.
Is the film roll properly selected?	Properly select the film roll which is currently installed on the printer.
Are you using the wrong size media?	Check the media settings and the film roll settings. Using the wrong media or the wrong film will cause errors to occur.

Two sheets of paper are fed at the same time.

Check	Possible remedy
Is there static electricity built up on the media?	Fan your media before loading it into the paper tray. For iron-on transfer sheets, always place the finishing sheet in the paper tray and manually feed one transfer sheet at a time.

Other DIP switch settings

This printer has 10 DIP switches located on the back, as mentioned earlier in this manual. The following information is provided to help you should you ever need to adjust the printer's performance in the future. We recommend that switches other than 7 through 9 for print intensity ordinarily be left alone.

Print Type	Items that can be changed with the DIP switches
Normal printing ^(Note 1) (printing from Windows)	<ul style="list-style-type: none"> • Overall print intensity (7 levels from +3 to —3) • Sets slow speed mode ^(Note 2)
Test print	<ul style="list-style-type: none"> • Change of film rolls (5 types) • Change of print media/size (3 types/2 types) • Overall print intensity (7 levels from +3 to —3)

Note 1: Windows settings take priority over DIP switch settings.

Note 2: This sets Low print speed which is useful for areas with high intensity or patterns.

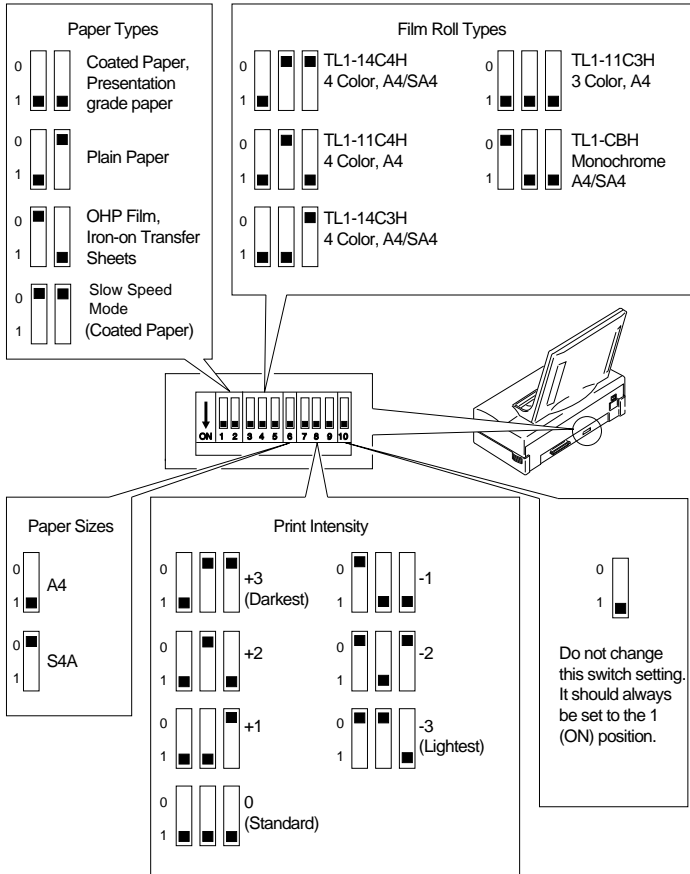

Pinout of interface connector

This printer uses a standard 8 bit parallel interface connector (Centronics interface). The following information is the pin assignment of the interface connector.

Pin	Signal
1	$\overline{\text{DATA STROBE}}$
2	DATA 1
3	DATA 2
4	DATA 3
5	DATA 4
6	DATA 5
7	DATA 6
8	DATA 7
9	DATA 8
10	$\overline{\text{ACKNLG}}$
11	BUSY
12	EOP
13	ON LINE
14	GND
15	
16	GND
17	CHASSIS GND
18	+5V (Max. 160mA)

Pin	Signal
19	GND
20	GND
21	GND
22	GND
23	GND
24	GND
25	GND
26	GND
27	GND
28	GND
29	GND
30	GND
31	$\overline{\text{INPUT PRIME}}$
32	$\overline{\text{FAULT}}$
33	GND
34	EOI
35	
36	

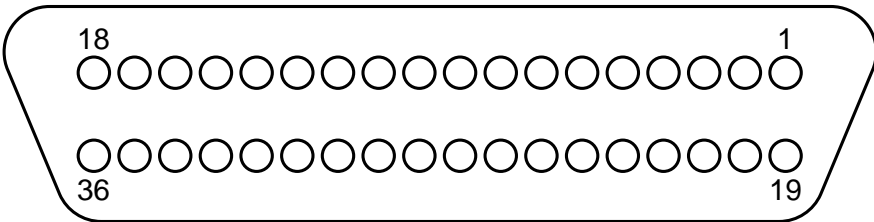

Chapter 5 Reference information

Specifications

Engine

Printing process	Thermal wax transfer
Resolution	300 X 300 dpi

Printing speed

Letter size paper	Monochrome	31 seconds/page
	3 color (YMC)	64 seconds/page
	4 color (YMxCB)	80 seconds/page
A4 size paper	Monochrome	32 seconds/page
	3 color (YMC)	67 seconds/page
	4 color (YMxCB)	85 seconds/page
Legal size paper	Monochrome	37 seconds/page
	3 color (YMC)	87 seconds/page
	4 color (YMxCB)	107 seconds/page
Special A4 size paper	Monochrome	37 seconds/page
	3 color (YMC)	87 seconds/page
	4 color (YMxCB)	107 seconds/page

Paper feed

Speed	Paper:	4, 6, 8 or 10 ms/line (depending on data transfer speed)
	OHP film:	6, 8 or 10 ms/line (depending on data transfer speed)
Paper handling	Paper tray	Capacity: 50 sheets of coated/presentation grade paper
		Paper stacker: 10 sheets
		Manual insertion: Available

Characters

	No resident font
Software fonts:	35 TrueType fonts (on floppy disk)

TrueType fonts are supplied on disk for use with Windows 3.1 applications.

Memory

Standard RAM size is 512 KB.

Interface

Centronics parallel

Power supply

120VAC, 220VAC, 230VAC, 240VAC, 50/60Hz
(varies according to the country of purchase)

Power consumption

At standby: 17W
At printing: 120W

Dimensions

14.13" (W) x 10.08" (D) x 5.04" (H)
(359mm (W) x 256mm (D) x 128mm (H))

Weight

16.5 lbs. (7.5 kg.)

Reliability information

Printer life

25,000 pages or 5 years

Printer head life

5,000 pages (A4 size, 3 color, 20% duty)

Noise level

ISO-7779
53.0 dB

Environment

Temperature

Operating: +10° to +35°C (50° to 95°F)
Non-operating: -20° to +55°C (-4° to 131°F)

Humidity

Operating: 30 to 70% RH (no condensation)
Non-operating: 30 to 90% RH (no condensation)

Printer supply accessories

Film roll

TL1-11C3H-30

Color type: 3 color (YMC) film roll

Size: Page length is less than 11" (Letter and A4)

Life: 30 pages per roll

Coated paper

A-PWC-30 (for American market)

Size: Letter

Packaging: 30 sheets

Presentation grade
paper

A4-PW-30 (except for American market)

Size: A4

Packaging: 30 sheets

Printer supply options

Film roll

TL1-11C3H	Color type:	3 color (YMC) film roll
	Size:	Page length is less than 11" (Letter and A4)
	Life:	80 pages per roll
TL1-14C3H	Color type:	3 color (YMC) film roll
	Size:	Page length is less than 14" (Letter, A4, Legal, SA4)
	Life:	69 pages per roll
TL1-11C4H	Color type:	4 color (YMxCB) film roll
	Size:	Page length is less than 11" (Letter and A4)
	Life:	59 pages per roll
TL1-14C4H	Color type:	4 color (YMxCB) film roll
	Size:	Page length is less than 14" (Letter, A4, Legal, SA4)
	Life:	47 pages per roll
TL1-CBH	Color type:	Monochrome film roll
	Size:	Page length is less than 14" (Letter, A4, Legal, SA4)
	Life:	200 pages per roll (at Letter or A4)

Coated paper

A-PWC	A4-PWC
Size: Letter	Size: A4
Packaging: 100 sheets	Packaging: 100 sheets
SA-PWC	SA4-PWC
Size: Legal	Size: Special A4
Packaging: 100 sheets	Packaging: 100 sheets

Presentation grade paper

A-PW	A4-PW
Size: Letter	Size: A4
Packaging: 100 sheets	Packaging: 100 sheets
SA-PW	SA4-PW
Size: Legal	Size: Special A4
Packaging: 100 sheets	Packaging: 100 sheets

OHP film

A-TFC	A4-TFC
Size: Letter	Size: A4
Packaging: 100 sheets	Packaging: 100 sheets
SA-TFC	SA4-TFC
Size: Legal	Size: Special A4
Packaging: 100 sheets	Packaging: 100 sheets

Iron-on transfer sheets

T90IO-LTR	T90IO-A4
Size: Letter	Size: A4
Packaging: 100 sheets	Packaging: 100 sheets

Glossary

To further aid you in the understanding of the printer and computer peripherals, we have created this glossary of terms. Some of the terms listed in this glossary appear in this User's Manual, while others are commonly used computer terminology.

A

Application

A program that you use to perform a specific task on your computer. These include programs for word-processing or graphics creation.

ATM fonts

An abbreviation for **Adobe Type Manager**. This font system was developed by *Adobe Systems*.

Attribute

The characteristics of a font. It includes orientation, symbol set, spacing, pitch, point size, style, stroke and typeface.

B

Backup

To make a copy of the original floppy diskette or a file on the hard disk. Making a backup of your disks or files ensures that you won't lose data if the originals are lost or damaged.

Bit

Binary digit. This is the smallest unit of information that a computer can hold. The value of a bit (which is either 1 or 0) represents a two-way choice (on or off, true or false, black or white).

Bitmap

A set of bits that represent a graphic image.

Bitmapped character

A character in a font that's rendered as a bitmap and drawn as a pixel pattern on the screen. See also **font** and **pixel**.

Bitmapped font

A font in a single point size made up of bitmapped characters. Some fonts stored in the computer system are bitmapped fonts.

Buffer

A "holding area" in the memory where information can be stored by one program or device and then read by another. For example, some printers have built-in memory to store text that comes from the computer faster than it can be printed. This memory, which frees the computer for other work while the printer is printing is called a *printer buffer*.

Button

An image on your screen which resembles a push-button. You can click to designate, confirm or cancel an action.

Byte

A series of 8 bits that represent one character.

C

Cancel button

A button that appears in most dialog boxes which you can use to cancel any command or option you may have chosen.

Central processing unit (CPU)

The brain of the computer. It is the microprocessor which performs the actual computations.

Centronics parallel port

A standard wiring configuration for parallel data transmission. Centronics is often used as a synonym for the parallel standard developed by Centronics Inc.

Character set

The complete set of characters available in a font.

Checkbox

A small box associated with an option in a dialog box or window. You can click on the checkbox to turn the option on or off. An option is on when there is an X in the checkbox.

Click

To position the pointer arrow on an object on your display and to press the left button of your mouse.

Color balance

This function adjusts the overall balance of the three colors of red, green and blue. This is good for enhancing some of the colors you want to use in your presentation documents.

Command

An instruction that causes the computer to perform some action.

Configuration

(1) Your computer set up. (2) Your hardware: the computer, displays, keyboard and peripheral devices.

CPI

An abbreviation for Characters Per Inch.

D

Data bits

The number of bits in a transmitted byte that actually contains data.

Default

A preset value or setting on your computer which you can change.

Dialog box

A box which contains a message or instructions for you to follow or a box containing options from which you can select.

Document

Whatever you created on your computer using an application program.

Double-click

To position your pointer arrow on an object, such as an icon, and to press the left mouse button twice in quick succession without moving your mouse.

Drag and drop

To position your pointer arrow on an object and press and hold the left mouse button, moving the mouse and releasing the button.

E

EEPROM

Electronically Erasable Programmable Read Only Memory. It has an internal switch to permit the user to erase the contents and write new contents into it by means of electrical signals.

Engine

This is the mechanical printer developer and laser portion of the printer.

Emulation

One printer's imitation of the functions of another printer.

Error Diffusion

This is a type of dithering process which results in a softer printed image. It is useful for printing photographic images.

Expansion RAM board

An available option that is easily attached to the computer to increase memory.

F

Fast Print to Port

This function of the **Options** dialog box, will send your print job directly to the LPT port without going through Windows' Print Manager.

File

A named, ordered collection of information stored on your hard disk or floppy disk.

File menu

A menu that lists commands that affect your documents. File menus typically contain commands such as Save, Print and Quit.

Film Roll

This is the thermal wax roll which contains ink used in printing documents.

Floppy disk

A disk made of flexible plastic which stores information from your computer. Floppy disks come in two types: 3.5" and 5.25."

Font

A set of letters, numbers or symbols of the same typeface design.

G

Gamma Correction

Gamma is used to adjust the mid-range color density of your image.

H

Halftone

This setting in the **Options** dialog box allows you to define how sharp you want the printed image to appear. There are three types with this printer driver: **Spiral**; **Mesh**; **Error Diffusion**.

Handshaking

In data communications, the automatic acknowledgment by the receiving device of information that has been sent to it, either by signals and the interface ("hard") or by software controls ("soft").

Hex dump

Conversion by the printer of ASCII symbols into their hexadecimal (base 16) equivalent. This is useful for programmers or other users who want to troubleshoot the communications between the computer and the printer.

I

Icon

A small pictorial representation of an item on your computer's desktop in Windows.

Interface

A hardware plug that allows cable connections of two devices. For example, a cable from a computer parallel port to a printer's parallel port.

L

Landscape

Printing on paper across its wider dimensions, such as a spreadsheet that is 11 inches wide and 8.5 inches high; landscape pictures are usually wider than they are tall.

M

Megabyte

1024 kilobytes, or 1,048,576 bytes. Also represented as **MB**.

Memory

Part of the computer system that can store information and retrieve it later.

Menu

A list of items either in the group windows or in your applications from which you can select. These are selected by clicking on them with your mouse button.

Mesh

This is a type of dithering method which is part of the Halftone setting in the printer driver's **Options** dialog box. The dithering cells are larger than Spiral which makes misregistration of color less noticeable.

Mirror

This function, in the printer driver **Setup** dialog box, will cause your image to be printed vertically reversed.

Mouse

A device that controls the pointer arrow on your display in Windows.

Mouse button

The button on the top of the mouse which you press to make selections or do some action on your screen.

MS-DOS

Microsoft Disk Operating System.

P

Parallel

A communications interface that sends or receives 8 bits of information plus control signals at a time.

Parity

A bit in a serial information that allows a computer and printer to automatically check for errors in transmission.

Point

This is the typical unit of measurement for height of a font. One point equals 1/72nd inch.

Portrait

Printing on paper across the narrower dimensions, such as a letter on paper which is 8.5 inches wide and 11 inches high; portrait pictures are usually taller than they are wide.

PostScript

PostScript is a printer page description language developed by *Adobe Systems* to communicate between software applications and printers, independent of the printer's resolution.

R

RAM

Random Access Memory. This is memory that can be used to store information temporarily such as text or printing configurations. RAM-stored information is erased when the power is turned off.

ROM

Read Only Memory. This is memory which can be stored permanently whether the power to the computer is on or off.

S

Scalable fonts

These are fonts created within the printer on a character-by-character basis ensuring high speed and print quality. In virtually limitless sizes, these fonts can be scaled from 3 points to 999.75 points in quarter-point increments.

Serial

A communications interface that sends or receives 1 bit of information at a time at a specified baud rate.

Spiral

This is a type of dithering method where the dithering cells are somewhat smaller than **Mesh**. It produces finer images for graphics and presentations.

System fonts

These are fonts that are installed and used by Windows during a normal installation.

T

Title bar

The bar at the top of your window that shows the name of the current window.

TrueType font

A type of scalable font supplied with the Star WinType 800C printer and used in Windows to create WYSIWYG (What You See Is What You Get) output. This font system was developed by Apple Computer.

U

Use Max. Memory

This is a setting in the **Options** dialog box for sending data to the printer via Windows' Print Manager.

V

Virtual memory

A method by which a computer substitutes hard disk space for **RAM**.

W

Window

An area of your display which shows information on your desktop. You can create and view documents through windows.

Windows

A graphical user interface software program developed by Microsoft Corporation for use on MS-DOS computers.

WYSIWYG

An abbreviation of What You See Is What You Get.

Index

Symbols

3-color	22, 28	Control panel	15
386 Enhanced	27		
4-color	22, 28		
A			
A4	28		
Accessories carton	1		
Auto	29		
B			
Backup copy	11		
Benzine	41		
Black Only	29		
Black Representation	29		
Brightness of tones	25		
Browse...	12		
C			
Centronics parallel interface cable	9		
Changing density	26		
Changing gamma correction	25		
Changing halftones	24		
Changing halftones and image quality	24		
Changing the film roll setting	35		
Characters	57		
Cleaning the inside of the printer	41		
Cleaning the outside of the printer	41		
Clearing paper jams	46		
Coated paper	2, 22		
Color balance	26		
Connecting the power cord	8		
Connecting the printer			
to your computer	9		
D			
Darkness			23
Description			51
Dimensions			58
DIP switch settings			23
Dispose of used film			34
E			
Electric shock			51
Engine			57
Environment			58
Error Diffusion			25
F			
Fast Print to Port			23
Features of the printer			16
Feed SA4 media			32
Feeder mechanism			46
Film			22
Film roll			28
Film roll bobbins			1, 5, 34
G			
Gamma correction			25
Genuine Star supplies			2
Glossary			61
H			
Halftone			25
High speed printing			26
High voltage			51

I

Installing the film roll	5
Installing the printer driver	11
Installing the printer driver software	11
Intensity	30
Interface	58
Interface cable	9
interface connector	56
Interface port	9
Iron-on transfer sheets	2, 21, 37

J

Jammed inside of the machine	47
------------------------------	----

L

Landscape	22
Lightness	23
Loading print media	17
Low	29
LPT1	14

M

Main group	21
Maintaining your printer	41
Maintenance & troubleshooting	41
Manual loading	19
Media type	16, 22
Medium	29
Memory	iii, 11, 58
Mesh	25
Monochrome	28

N

Not Ready mode	15
----------------	----

O

Operating the printer	17
Options button	22
Options menu	22
Organic solvents	41
Overhead projection (OHP) film	2, 21

P

Package contents	1
Paper extract rollers	44
Paper feed	57
Paper feeders	44
Paper feeding	51, 54
Paper jams	54
Paper lamp	15, 46
Paper pinch rollers	44
Paper tray	4, 17, 33
Paper tray base	1, 4
Paper tray cover	1
Parallel interface cable	3
Performance	26
Photo	30
Placing the printer	3
Plain paper	22
Portrait	22
Power cable	1
Power supply	51, 52, 58
Preparing to print	3
Presentation grade paper	2, 22
Print Monitor	27
Print speed	29, 28
Printable area	19
Printer driver	1, 11
Printers icon	21
Printing	23, 51, 52
Printing on special A4 size media	31

Printing speed	57	Text	30
Printing with iron-on transfer sheets	37	Thermal print head	34
Printing with WinType 800C	15	Thinners	41
Program Manager	12, 21	Top cover	7, 33
Protective pieces	6, 49	Top Cover Support Bar	33
Protective sheet	49	Transporting your printer	48
		Troubleshooting	51
		TrueType font samples	14
R		TrueType fonts	11, 57
RAM	iii, 11	Turning OFF the power	17
Ready button	15	Turning ON the power	17
Ready lamp	15	Type of ink	22
Ready mode	15		
Recommended coated paper	4	U	
Reference information	57	Unpacking and checking	
Region of problem	51	the package contents	1
Reliability	58	Use Max. Memory	27
Replacing the film roll	33		
Run	12	W	
		Weight	58
S		Windows	11
Sensitive information	34		
Sensor	33		
Setting up your printer	1		
Setup button	21		
Silicon	37		
Socket protective sheet	6		
Software fonts	57		
Special A4	28		
Specifications	57		
Spiral	25		
Starter 3-color film roll	1		
System requirements	iv, 11		
T			
Take-up roll	7		
Test print	8		

Customer service information

In the event that you are experiencing some technical difficulty with your Star printer, please refer to Chapter 7 Maintenance & troubleshooting. That chapter provides you with easy methods to diagnose and resolve problems which you may encounter.

For further technical support, you should first contact your Authorized Star Dealer. If you require additional support, Star Micronics offers a wide variety of technical support services. Please use the phone numbers listed below based on the country which your Star printer was purchased.

Star Micronics Technical Hotline:

North America:	1-908-572-3300	Australia:	61-2-748-4300
Hong Kong:	852-795-2335	New Zealand:	64-9-570-1470

Star Micronics FaxBack (Document Retrieval) System:

Requires access to a facsimile machine or board with receive capability

North America:	1-908-572-4004
----------------	----------------

Star Micronics Bulletin Board Service:

Requires a computer modem

North America:	1-908-572-5010
United Kingdom:	44-494-461395
France:	33-1-305807
Germany:	49-69-780929
Netherlands:	31-73-424485
Australia and New Zealand:	61-2-748-2960

Customer response

Star Micronics Co., Ltd., invites your suggestions and comments on your printer and this Users Manual. Please address your correspondence to Attn: Product Manager

Worldwide Headquarters

536 Nanatsushinya
Shimizu, Shizuoka Japan 424

North and South America Markets

STAR MICRONICS AMERICA, INC.
70-D Ethel Road West
Piscataway, NJ 08854

Australian Market

STAR MICRONICS PTY. LTD.
Unit A/107-115 Asquith Street
Silverwater, NSW 2141, Australia

Asian Market

STAR MICRONICS ASIA LTD.
18/F Tower 2, Enterprise Square
9 Sheung Yuet Road, Kowloon Bay,
HONG KONG

U.K. Market

STAR MICRONICS UK., LTD.
Star House
Peregrine Business Park
Gomm Road, High Wycombe
Bucks. HP13 7DL, U.K.

New Zealand Market

STAR MICRONICS (N.Z.) LTD.
64 Lunn Ave, Mount Wellington
P.O. Box 6255 Wellesley St.
Auckland, New Zealand

European Market

STAR MICRONICS DEUTSCHLAND GMBH
Westerbachstraße 59
D-60489 Frankfurt, F.R. of Germany