

Microsoft[®] Mouse

*Read this manual first!
Includes installation
instructions.*

Microsoft[®]

Microsoft[®] Mouse User's Guide

**For IBM[®] Personal
Computers and
Compatibles**

Information in this document is subject to change without notice and does not represent a commitment on the part of Microsoft Corporation. The software described in this document is furnished under a license agreement or a nondisclosure agreement. The software may be used or copied only in accordance with the terms of the agreement.

© Copyright Microsoft Corporation, 1984, 1985, 1986

Microsoft®, the Microsoft logo, and Multiplan® are registered trademarks, and InPort™ and MACH 10™ are trademarks, of Microsoft Corporation.

IBM® and PC AT® are registered trademarks, and PC/XT™ and 3270 PC™ are trademarks, of International Business Machines Corporation.

COMPAQ® is a registered trademark of COMPAQ Computer Corporation.

Hercules™ is a trademark of Hercules Computer Technology.

In-a-Vision™ is a trademark of MICROGRAFX, Inc.

Lotus® and 1-2-3® are registered trademarks of Lotus Development Corporation.

Reflex™ is a trademark of Borland International, Inc.

Contents

Microsoft Mouse: Compatible Devices v

Introduction vii

About This Guide viii

What You Should Read viii

MREADME.DOC ix

Installing the Mouse

2

1 Getting Started 5

What You Need 5

Mouse Versions 5

The Bus Mouse 5

The Serial Mouse 6

The InPort Mouse 6

2 Installing Mouse Hardware 7

Installing the Bus Mouse 7

Before You Start 7

Installing the Adapter in Your Computer 9

Installing the Serial Mouse 12

Installing the InPort Mouse 13

3 Setting Up Mouse Software 15

The Startup Disk 15

Running the Startup Program 16

Making Copies of the Disks in Your Mouse Package 16

Setting Up the Mouse Software 17

Running MSETUP from DOS 19

Using the Mouse

- 4 Moving the Mouse 22**
 - "Using the Mouse" Tutorial 22
 - Basic Mouse Movements 22
 - Pointing with the Mouse 23
 - Clicking the Mouse Buttons 23
 - Selecting a Portion of the Screen 23
 - Piano Demonstration Program 24
 - Starting Piano 24
 - Practicing Piano 25
 - Quitting Piano 25
 - The Control Panel 26
- 5 Cleaning the Mouse 29**
- 6 Other Sources of Information 31**
 - Prewritten Mouse Menu Programs 31
 - Mouse Menu Documentation 31
 - Using the Mouse with Other Microsoft Products 31
 - Finding Technical Information 32
- Index 33**

Microsoft Mouse: Compatible Devices

The Microsoft® Mouse is designed to be used with the following computers:

- The IBM PC family of computers (including the PC, PC/XT, Portable PC, PC AT, and 3270 PC) or computers that are *100% compatible*
- The COMPAQ family of computers
- The AT&T 6300
- The Olivetti M24

The Microsoft Mouse hardware and software support the following displays:

- IBM Monochrome Display
- IBM Color Display
- IBM Enhanced Color Display
- A display that is *100% compatible* with one of the displays listed above

The Microsoft Mouse hardware and software support the following display adapters:

- IBM Monochrome Adapter
- IBM Color/Graphics Adapter
- IBM Enhanced Graphics Adapter
- IBM All Points Addressable Adapter (for the IBM 3270 PC)
- Hercules Graphics Card
- A display adapter that is *100% compatible* with one of the adapters listed above

Note Monochrome display adapters can only be used with character-based programs. In order to run graphics-based programs, you must have a graphics display adapter.

Compatible computers

Compatible displays

Compatible display adapters

Introduction

The Microsoft Mouse is a hand-held pointing device that allows your computer to fit into your workday as easily and as quietly as the mouse glides across your desk top. With its speed, accuracy, and simplicity, the mouse will become an indispensable part of your work environment.

You can use the Microsoft Mouse with bread-and-butter products such as Microsoft Windows, Microsoft Word, Reflex, In-a-Vision, and Show Partner. And in your free time, you can use your mouse to paint a picture with Microsoft Paintbrush, or pilot your plane through turbulent skies with Microsoft Flight Simulator.

Use your Microsoft Mouse to move or delete text in an instant, insert a value into a spreadsheet cell, or select a command on a menu. All you do is point to an area on the screen and then click a mouse button.

About This Guide

The *Microsoft Mouse User's Guide* has two parts. Part 1 explains how to install the Microsoft Mouse. Part 2 explains how to use the Microsoft Mouse.

Note This guide assumes you are familiar with your computer's hardware, and with basic DOS (Disk Operating System) commands and procedures. You may want to keep your computer's user's guide and the DOS manual that came with your computer at hand to refer to while you are installing the mouse.

What You Should Read

Installing the mouse

First read Part 1, "Installing the Mouse," Chapters 1 through 3. In Chapter 2, "Installing Mouse Hardware," read only the section that applies to your version of the Microsoft Mouse.

Using the mouse

In Part 2, "Using the Mouse," you may want to skip most of Chapter 4, "Moving the Mouse," if you have used a mouse before. However, be sure to read:

- "The Control Panel" section in Chapter 4
- Chapter 5, "Cleaning the Mouse"

Read Chapter 6, "Other Sources of Information," if you are interested in prewritten mouse menus that allow you to use the mouse with applications that don't offer mouse support (such as Lotus 1-2-3), or if you would like to order the optional *Microsoft Mouse Programmer's Reference Guide*, which explains how to design your own mouse menu programs or mouse interface.

MREADME.DOC

The Startup disk in your mouse package may include a file named MREADME.DOC. You should read this file for additional information that became available after this manual was printed.

To read this file on your screen:

- 1 Start DOS. (If necessary, refer to the DOS manual that came with your computer.)
- 2 Insert the Startup disk into drive A. At the DOS prompt, type:

type a:mreadme.doc

then press ENTER.

If you want a printout of this file:

- 1 At the DOS prompt, type:

copy a:mreadme.doc prn

then press ENTER.

Installing the Mouse

This section provides instructions for installing the mouse hardware and software.

- Chapter 1, "Getting Started," lists what you need to install and use the Microsoft Mouse. It also describes each version of the mouse.
- Chapter 2, "Installing Mouse Hardware," explains how to install the Bus Mouse Adapter in your computer's system unit, and how to attach the Bus, Serial, and InPort™ versions of the Microsoft Mouse to your computer.
- Chapter 3, "Setting Up Mouse Software," explains how to make backup copies of the disks in your mouse package and set up the mouse software.

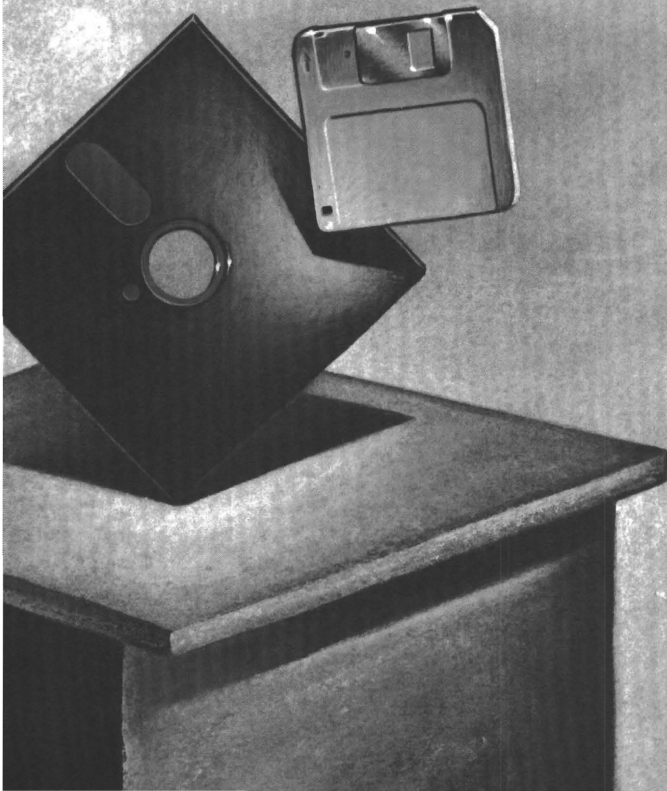

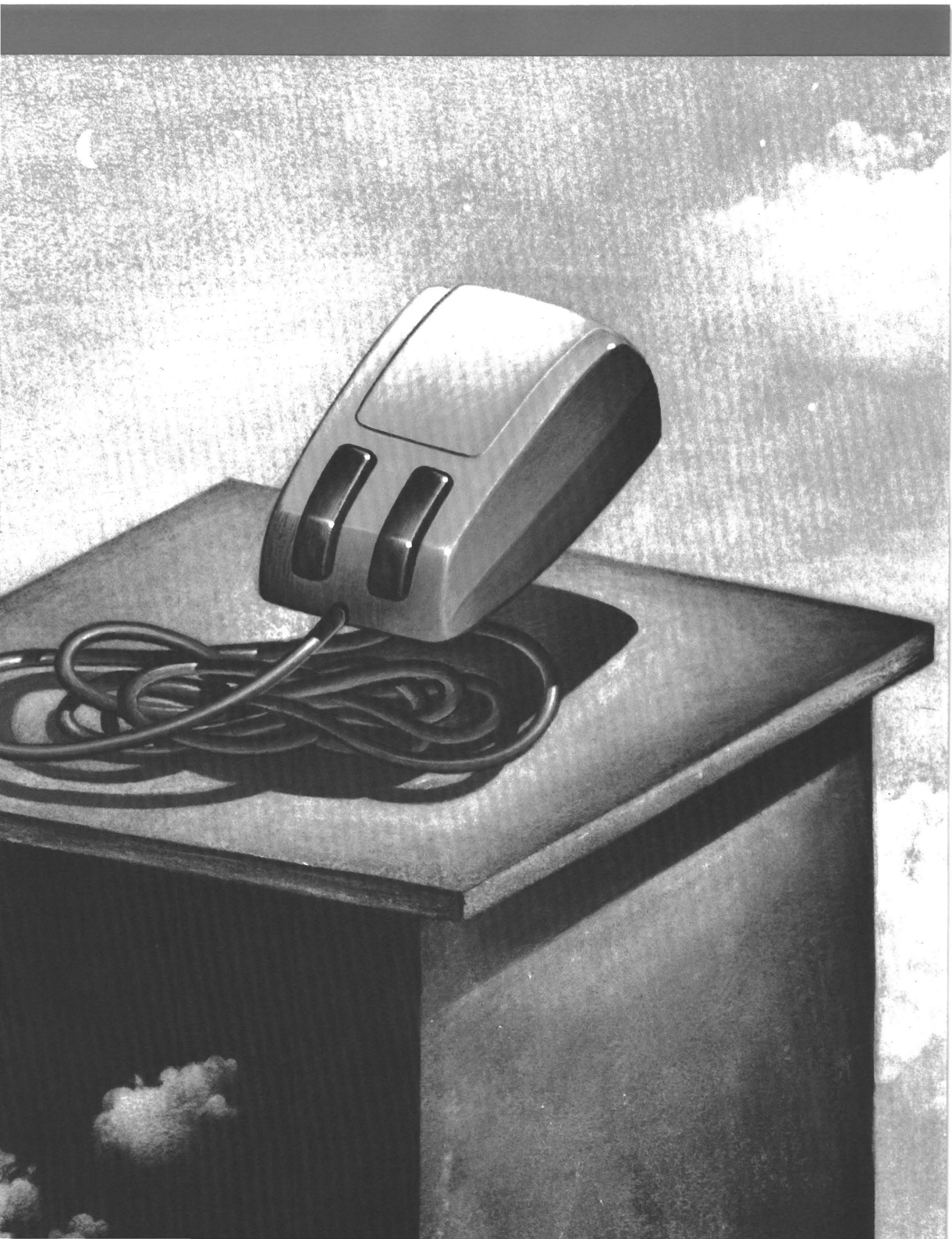

1 Getting Started

What You Need

To install and use the Microsoft Mouse, you need:

- A personal computer, display, and display adapter (see “Microsoft Mouse: Compatible Devices” at the beginning of this manual for a complete list of devices with which you can use the mouse)
- The DOS (Disk Operating System) files, version 2.0 or later
- A medium-size, flat-blade screwdriver (Bus version only)

Make sure the following items were included in your mouse package:

- A Microsoft Mouse with attached cable and connector
- A Bus Mouse Adapter (Bus version only)
- The Startup disk

You should have

Mouse Versions

The Microsoft Mouse is available in three versions:

- Bus version (Microsoft part number 037-299)
- Serial version (Microsoft part number 039-199)
- InPort version (Microsoft part number 037-399)

The Bus Mouse

The Bus version of the Microsoft Mouse consists of a Microsoft Mouse and the Bus Mouse Adapter (a printed circuit board), which you must install in an available expansion slot in your computer.

The Serial Mouse

The Serial version of the Microsoft Mouse can be connected to any available 25-pin serial port on your computer. You can use the Serial Mouse with the IBM PC AT (or a computer with a compatible 9-pin serial port) if you use the 25- to 9-pin adapter cable that comes in the Serial Mouse package.

The InPort Mouse

The InPort version of the Microsoft Mouse can be used with the Microsoft MACH 10™ or with other hardware products that support the Microsoft InPort Interface.

2 Installing Mouse Hardware

This chapter explains how to install the Bus, Serial, and InPort versions of the Microsoft Mouse. Read only the section that explains how to install your particular version of the Microsoft Mouse.

If you have a(n)	Then read	What you should read
Bus Mouse	"Installing the Bus Mouse"	
Serial Mouse	"Installing the Serial Mouse"	
InPort Mouse	"Installing the InPort Mouse"	

Installing the Bus Mouse

Before You Start

To ensure trouble-free performance of your mouse after you have installed the Bus Mouse Adapter, discharge any static electricity by touching the back of the system unit before you handle the adapter. You should also avoid contact with materials that create static electricity, such as plastic, vinyl, and Styrofoam.

Look carefully at the Bus Mouse Adapter (illustrated in Figure 2.1). The gold-striped edge at the bottom of the adapter is the connector that fits into an empty expansion slot on your computer's system board. Keep this connector free of dust and dirt to ensure a good connection when you install the adapter in the expansion slot.

The Bus Mouse Jumper

The Bus Mouse Adapter is equipped with a *jumper* that must be set so that the mouse does not interfere with the type of computer you are using or the other adapters installed in your computer. The *jumper* consists of a plastic block and a small, removable clip that fits over one of four pairs of pins on the block to specify the *interrupt* that the mouse uses.

Handling precautions

Interrupts

Interrupts are temporary breaks in the sequence of a program that are sent to the computer by various input/output devices such as printers, keyboards, and drawing devices. Since no two devices can use the same interrupt, you may need to change the default setting of the jumper block on the Bus Mouse Adapter, depending on your system's configuration.

The jumper block, shown in Figure 2.1, is labeled J4 on the Bus Mouse Adapter, and the pin pairs are labeled 2, 3, 4, and 5, from left to right. The pin pair labeled 2 is the default setting, and is covered by a jumper clip.

2.1 Microsoft Bus Mouse Adapter

Hold the adapter by this corner.

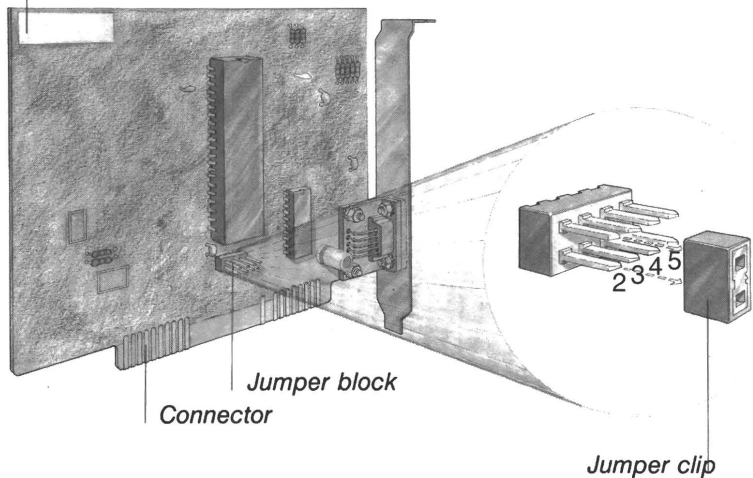

Changing the jumper setting

To determine if you have to change the jumper setting, refer to the following table. First make a list of jumper settings that *aren't* allowed for the type of computer you are using or for the other adapters installed in your system. Then use any setting that *isn't* on your list.

If you have	Do not use pair
Any PC with a hard disk (except the IBM PC AT or AT compatibles)	5
Asynchronous Communications Adapter: 1st serial port (com1)	4
Binary Synchronous Communications Adapter: 1st serial port (com1)	4
Synchronous Data Link Control Communi- cations Adapter	4 or 3
Asynchronous Communications Adapter: 2nd serial port (com2)	3
Binary Synchronous Communications Adapter: 2nd serial port (com2)	3
IBM 3270 PC (with or without a hard disk)	2
IBM Enhanced Graphics Adapter	2
IBM Network Adapter	2

When you change a jumper setting, position the jumper clip so that it covers both pins of the new pin pair.

Positioning the clip

Installing the Adapter in Your Computer

Follow these instructions to install the Bus Mouse Adapter in your computer:

- 1 Turn your computer off. Then turn off the power to any peripheral devices attached to your computer (such as printers and monitors).
- 2 Turn the system unit so that the back of the unit faces you; disconnect the power cord and any other cables from the back of the computer.
- 3 Remove the system unit cover. (If necessary, refer to your computer's user's guide.)
- 4 Locate the expansion slots at the rear of the system unit and choose any unused slot.

If you are using an IBM PC/XT, slot 8 cannot be used by the Bus Mouse Adapter.

If you are using an IBM 3270 PC, it is best to install the Bus Mouse Adapter in expansion slot 2. If the system does not have a printer adapter, however, you can install the Bus Mouse

IBM PC/XT

IBM 3270 PC

Adapter in slot 7. Or, if the system does not have a hard disk adapter, you can install the Bus Mouse Adapter in slot 5.

Note If necessary, refer to your computer's user's guide to determine how the expansion slots in your system unit are numbered.

- 5 Remove the screw that secures the expansion slot cover to the system unit, as shown in Figure 2.2. (Save the screw to secure the Bus Mouse Adapter's metal retaining bracket.) Then carefully remove the slot cover.

2.2 Removing the Expansion Slot Cover

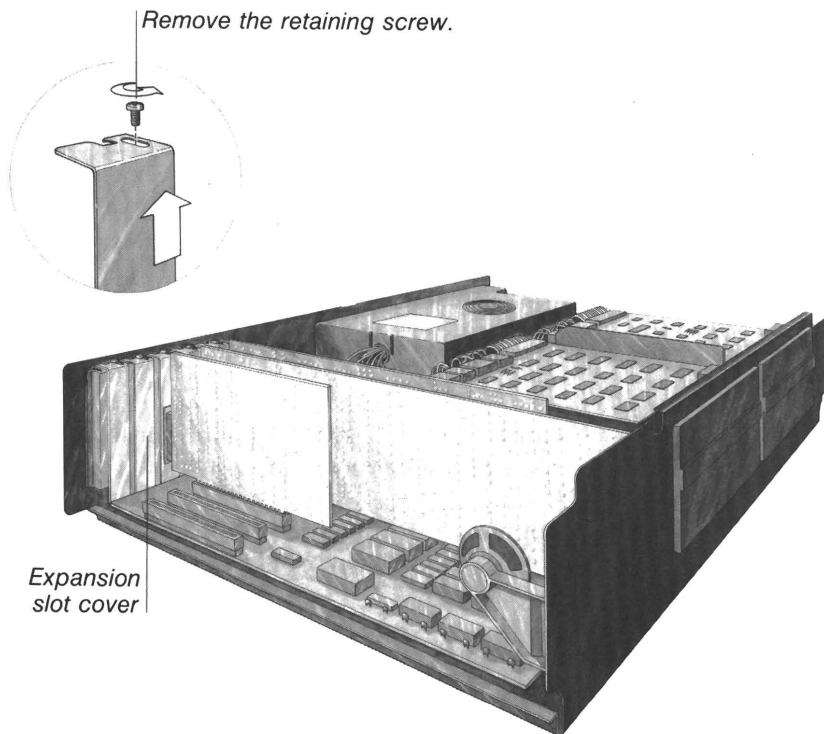

- 6 Grasp the upper edges of the Bus Mouse Adapter. Align the hole on the adapter's retaining bracket with the hole on top of the expansion slot, and align the gold-stripped connector with the expansion slot socket. Press the board firmly into the socket. (See Figure 2.3.)

Align the hole on the bracket with the hole on top of the expansion slot.

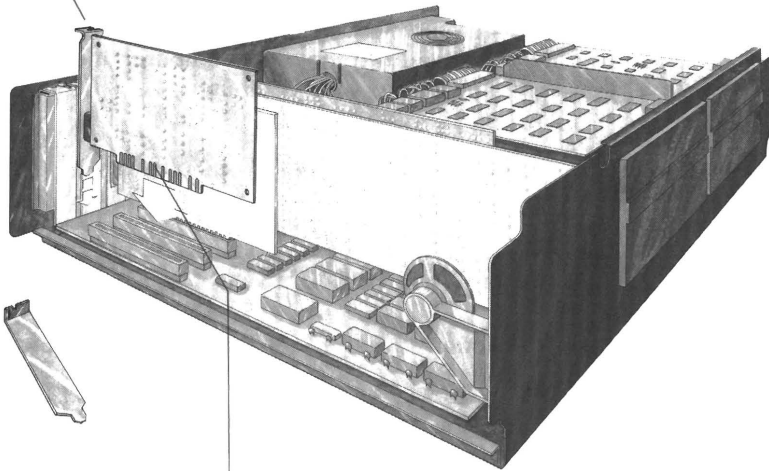

2.3 Installing the Bus Mouse Adapter

Press the adapter firmly into the socket.

- 7 Attach the mouse connector to the circular port on the Bus Mouse Adapter, as shown in Figure 2.4.

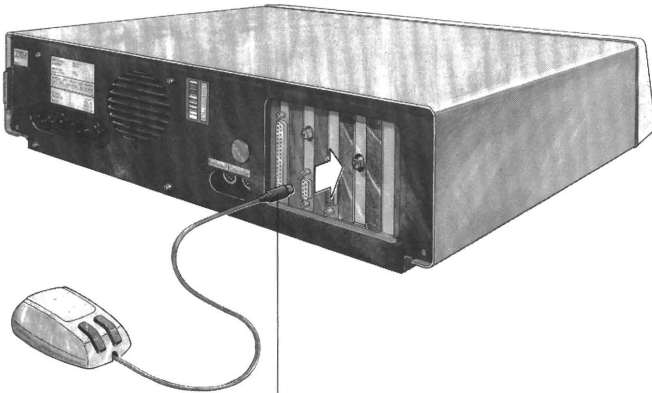

2.4 Connecting the Mouse to the Bus Mouse Adapter

Attach the mouse connector to the port on the adapter.

- 8 Make sure the slot on the top of the metal retaining bracket lines up with the hole on the top of the expansion slot. Replace the screw you removed from the expansion slot cover and tighten it so that the bracket is held in place.
- 9 Replace the system unit cover. Reconnect any cables you removed in step 2, and turn on your computer and any peripheral devices connected to your computer.

Now turn to Chapter 3, "Setting Up Mouse Software."

Installing the Serial Mouse

Follow these instructions to install the Serial version of the Microsoft Mouse:

- 1 Turn your computer off.
- 2 If you plan to attach the mouse to an adapter with a 25-pin serial port, locate the port on the back of the system unit, and insert the connector on the end of the mouse cable into the serial port, as shown in Figure 2.5. Then tighten the screws on the mouse connector.

2.5 Attaching the Mouse to a Serial Port

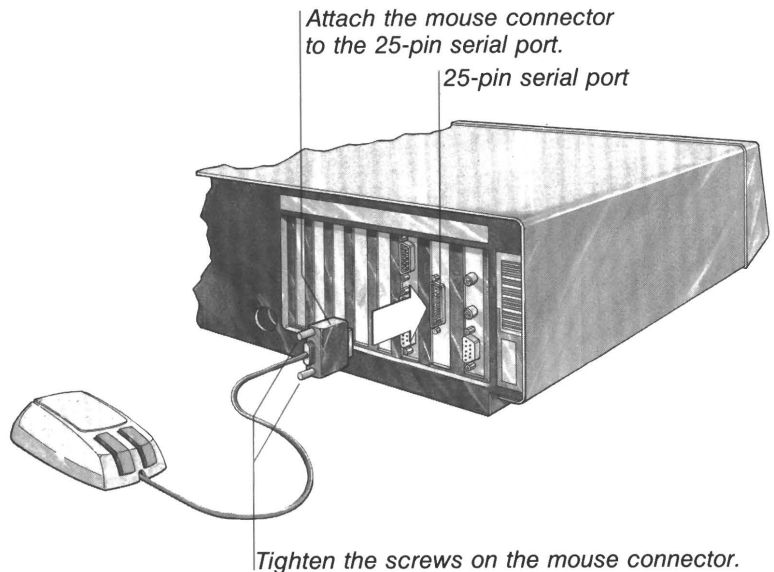

If you are installing the mouse on an IBM PC AT, you need the 25- to 9-pin adapter cable that was included in the Microsoft Mouse Serial version package. Attach the 9-pin (socket) connector on the adapter cable to a 9-pin serial port. Then attach the mouse cable to the 25-pin connector on the adapter cable.

Now turn to Chapter 3, “Setting Up Mouse Software.”

Installing the InPort Mouse

Follow these instructions to install the InPort version of the Microsoft Mouse:

- 1 Turn your computer off.
- 2 Locate the 9-pin circular port on one of the adapters installed in your computer. It should correspond to the 9-pin connector shown in Figure 2.6.

2.6 The Microsoft InPort Interface connector

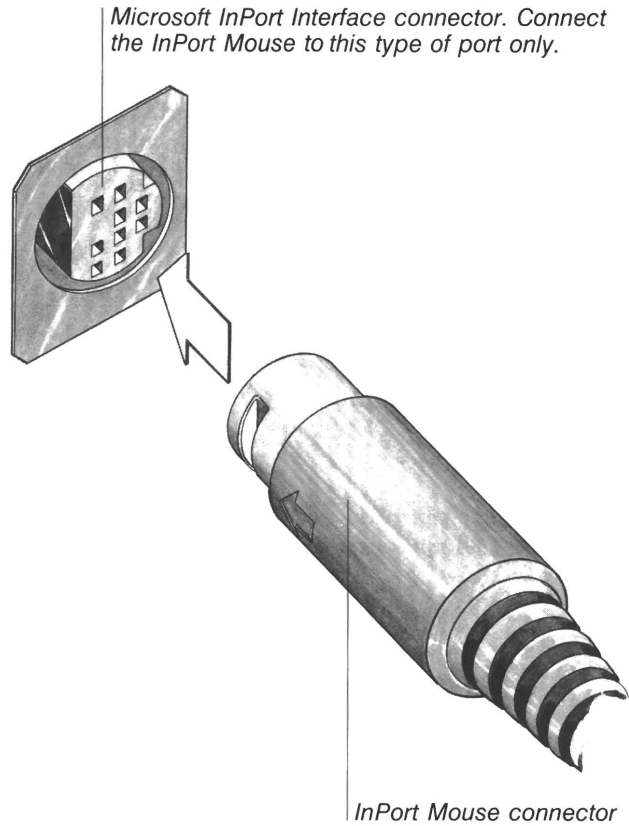

This port is the Microsoft InPort Interface connector, and is found on certain Microsoft products, and on some products of other manufacturers.

- 3 Attach the mouse cable to the Microsoft InPort Interface connector.

Note Some circular ports may look very similar to the Microsoft InPort Interface connector, but be incompatible with the connector on the InPort Mouse cable. If you can't connect the mouse cable easily, don't force it. Either locate the compatible circular port, or contact your computer dealer for assistance.

3 Setting Up Mouse Software

Like most hardware products you use with your computer, the mouse needs software to make it run. The Startup disk, one of the disks that came in the Microsoft Mouse package, includes all the software you need to set up and use the mouse.

The Startup Disk

As the name implies, the Startup disk should be the first disk you use after you have installed the mouse hardware. The Startup disk includes a Startup program that allows you to:

- Make backup copies of all the disks in your Microsoft Mouse package
- Set up the Microsoft Mouse software
- Set up the other software that is included in your mouse package
- View a demonstration that shows the features and capabilities of the Microsoft Mouse and of the other application software that is included in the mouse package
- Run the “Using the Mouse” tutorial (explained in Chapter 4, “Moving the Mouse”)
- Start the Piano demonstration program (explained in Chapter 4, “Moving the Mouse”)

Running Startup for the first time

The Startup program lists these items on the Startup menu and provides onscreen instructions for each. If you are running the Startup program for the first time, you should make copies of all the disks in your mouse package and then install the mouse software before you select any of the other items on the Startup menu.

Running the Startup Program

To load the Startup program:

- 1 Start DOS. (If necessary, refer to the DOS manual that came with your computer.)
- 2 Insert the Startup disk into drive A.
- 3 At the DOS prompt, type:

a:startup

and press ENTER. The Startup menu appears.

Making Copies of the Disks in Your Mouse Package

To make copies of the disks in your mouse package you will need a blank, unformatted disk for each disk and a copy of DOS (Disk Operating System).

To copy your disks:

- 1 Select "Make backup copies of your disks" from the Startup menu, then follow the onscreen instructions. First make a copy of the Startup disk, then make copies of the other disks in your mouse package.
- 2 Label the copy of each disk appropriately and store the original in a safe place. Use the backup disks as your working copies. After you have made copies of all the disks and you are ready to install the mouse software, make sure you are using the working copy of the Startup disk.

What you need

Setting Up the Mouse Software

A program called MSETUP is included on the Startup disk to “set up,” or install, the software the mouse needs in order to work with your computer. The MSETUP program copies the mouse driver, the software you need to load the mouse, to either your hard disk or to a floppy disk that contains the DOS system files. The program will ask you if you want to modify the disk so that the mouse driver is loaded automatically every time you start DOS. We recommend that you allow the MSETUP program to modify the disk. Otherwise, you must type *mouse* each time you start your computer.

If you are using a hard disk system, MSETUP asks you to specify to which subdirectory the mouse files should be copied. If you press ENTER without specifying a subdirectory, MSETUP automatically copies the mouse files to a directory named “MOUSE1”.

Note You should add the name of the mouse directory to the search path in your AUTOEXEC.BAT file so that you can easily access the mouse driver later, if necessary. (See the explanation of the PATH command in your DOS manual.)

If you are using a floppy disk system, MSETUP copies the mouse files onto a disk that includes the DOS system files. You will need:

- A DOS disk, version 2.0 or later, and a blank, formatted disk, if you want to create a new DOS disk that includes the mouse driver. For information about formatting disks, refer to the DOS manual that came with your computer.
- Any disks already containing the DOS system files that you want to copy the mouse driver to (such as application disks).

Note If a previous version of the Microsoft Mouse driver resides on an application disk to which you are about to copy the new mouse driver, erase the old mouse driver before running the MSETUP program.

Hard disk users

Floppy disk users

Running MSETUP

To run the MSETUP program:

- Select “Set up mouse software” from the Startup menu. Follow the onscreen instructions to install the mouse software.

Notes About MSETUP

MSETUP copies only the mouse driver from the Startup disk. To use any of the other mouse software, you must have your backup copy of the Startup disk in the current drive.

If you tell MSETUP that you want the mouse driver loaded automatically from a disk, MSETUP adds the appropriate command to the AUTOEXEC.BAT or CONFIG.SYS file that resides on the disk. If no AUTOEXEC.BAT or CONFIG.SYS file exists, MSETUP creates one. In most configurations of an IBM PC, IBM PC/XT, IBM PC AT, AT&T 6300, Olivetti M24, or a PC in the COMPAQ family of computers, MSETUP modifies or creates the CONFIG.SYS file. If you have an IBM 3270 or a PC with a network card, MSETUP creates or modifies the AUTOEXEC.BAT file.

Running MSETUP from DOS

If you decide to change your system's configuration after you have installed the mouse software, you must run MSETUP again to set up the mouse software for the new configuration. In this case, you can run the MSETUP program directly from DOS.

To run the MSETUP program from DOS:

- 1 Start DOS. (If necessary, refer to the DOS manual that came with your computer.)
- 2 Insert the Startup disk into drive A.
- 3 At the DOS prompt, type:

a:msetup

and press ENTER. Follow the onscreen instructions to re-install the mouse software.

Using the Mouse

This section explains how to use the mouse.

- Chapter 4, "Moving the Mouse," explains how to start a brief tutorial on using the mouse and describes the basic mouse techniques you will use with applications that support the mouse. It also explains how to use the Piano demonstration program and how to adjust mouse sensitivity using the Control Panel.
- Chapter 5, "Cleaning the Mouse," gives the procedure for cleaning the mouse.
- Chapter 6, "Other Sources of Information," tells you where to find information on prewritten mouse menu programs, which let you use the Microsoft Mouse with applications that do not usually support the mouse. It also explains where to find specific instructions on using the mouse with other Microsoft products, and how to obtain the technical information necessary to design your own mouse menu programs or mouse interface.

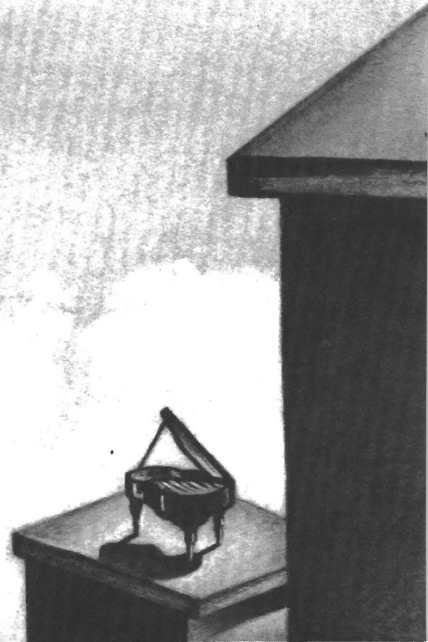
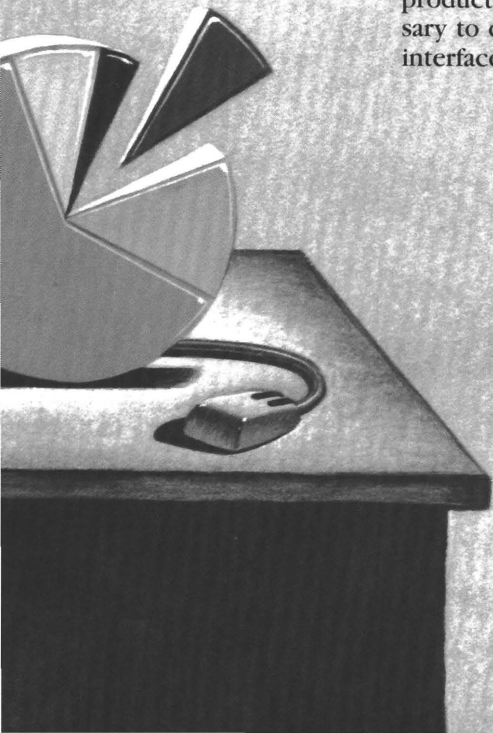

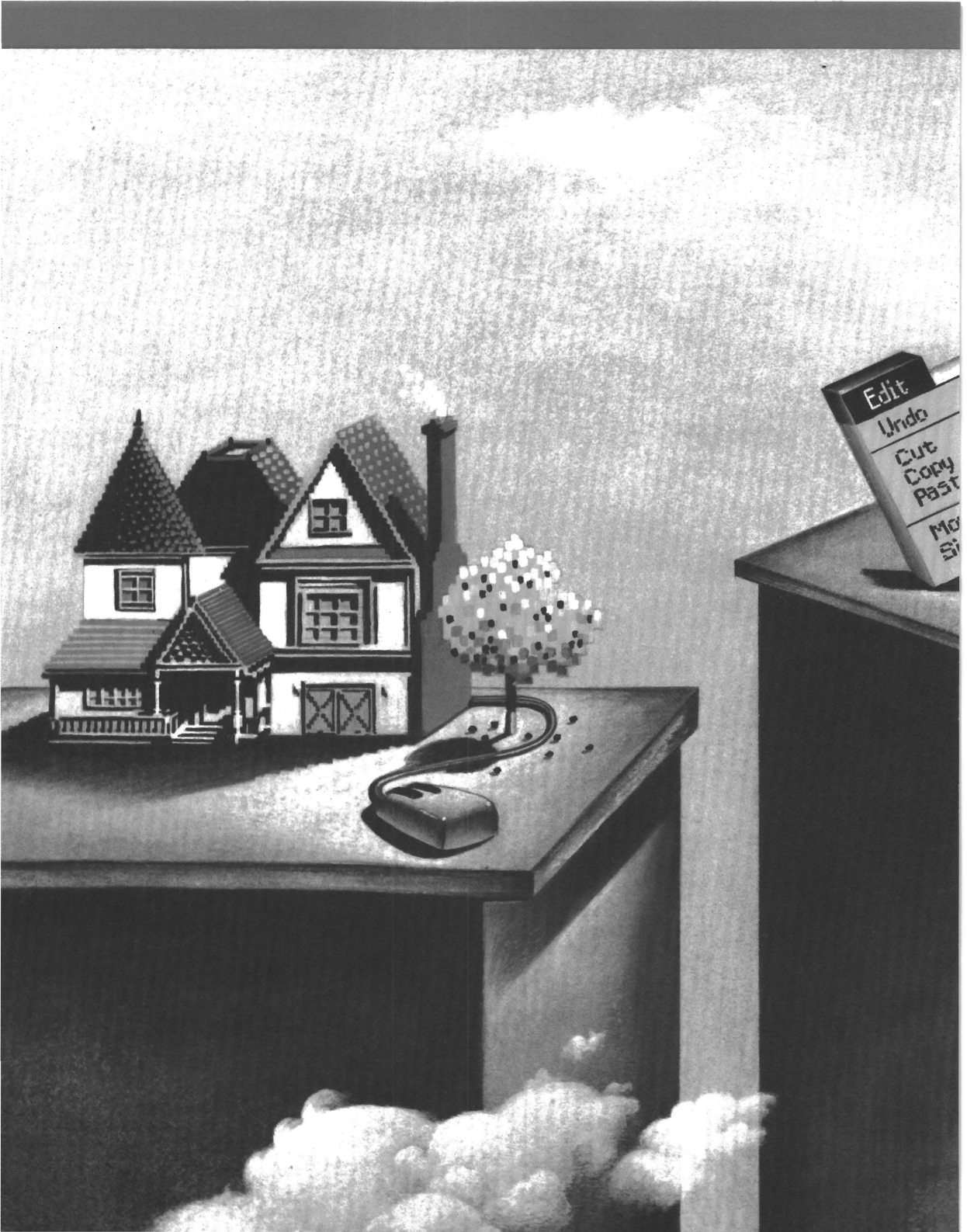

Edit

Undo

Cut

Copy

Paste

Move

Size

4 Moving the Mouse

In this chapter, you will first learn how to start a brief tutorial on using the mouse. Following this is a summary of the basic mouse techniques that you will use with all applications that support the mouse. You will also learn how to run the Piano demonstration program and how to adjust mouse sensitivity using the Control Panel.

“Using the Mouse” Tutorial

A brief tutorial called “Using the Mouse” is included on the Startup disk.

Note Before you can run the tutorial, you must install the mouse hardware and software, following the instructions provided in Chapters 1 through 3 in this guide.

To start the “Using the Mouse” tutorial:

- 1 Load the Startup program. (See “Running the Startup Program” in Chapter 3, “Setting Up Mouse Software.”)
- 2 Select “Using the Mouse” from the Startup menu.

Basic Mouse Movements

There are three basic mouse techniques that you will use with all applications that support the mouse:

- Pointing
- Clicking
- Selecting

Pointing with the Mouse

The mouse controls a cursor, or “pointer,” on your screen. The pointer can have a number of shapes. For example, if you are running a graphics-based program, such as Microsoft Windows, the pointer often appears as an arrow. If you are running a text-based program, such as Microsoft Multiplan®, the cursor appears as a blinking box.

You move the pointer on the screen by moving the mouse over your desk top in the direction you want the pointer to move. You can use the mouse to move the pointer to a particular location on your screen, or *point* at something on your screen.

Turn over your mouse

Look at the bottom of your mouse. The rubber-coated ball that you see rolls within its socket when you move the mouse across your desk top. The mouse translates the ball’s movement into signals that tell the computer how to move the onscreen pointer. The mouse doesn’t require much surface space in which to move—a circular area 5 inches in diameter will give you plenty of room.

Remember that it is the movement of the mouse that determines the movement of the pointer on the screen, not the location of the mouse on the desk top. You can pick up the mouse and move it to a different location on your desk without moving the pointer on the screen.

Clicking the Mouse Buttons

Clicking means to press and then quickly release a mouse button. By pointing to something on your screen and then clicking a mouse button, you *select* what is underneath the onscreen pointer.

Selecting a Portion of the Screen

To select a portion of your screen:

- 1 Move the mouse so that the pointer is at the beginning of the portion of the screen you wish to select. For example, if you wanted to select a paragraph of text, you would place the pointer on the first letter in the first word of the paragraph.
- 2 Press and hold down a mouse button while moving the pointer over the part of the screen you want to select, then release the mouse button. The section of the screen becomes highlighted as you move the pointer across it.

Piano Demonstration Program

The Piano demonstration program provided on the Startup disk lets you practice using the mouse by playing music on a keyboard that is displayed on your screen.

Starting Piano

You can start Piano in two ways: from the Startup program on the Startup disk, or directly from DOS.

To start Piano from the Startup program:

- 1 Load the Startup program. (See “Running the Startup Program” in Chapter 3, “Setting Up Mouse Software.”)
- 2 Select “Practicing Piano with the Mouse” from the Startup menu.

To start Piano from DOS:

- 1 Start DOS. (If necessary, refer to the DOS manual that came with your computer.)
- 2 Insert the Startup disk into drive A.
- 3 At the DOS prompt, type:

a:piano

and press ENTER.

After you have started Piano, the program prompts you to press the left mouse button if you have a color monitor, or to press the right mouse button if you have a black and white monitor. Once you have pressed the appropriate mouse button, the following screen appears:

What you see

4.1 Piano Screen

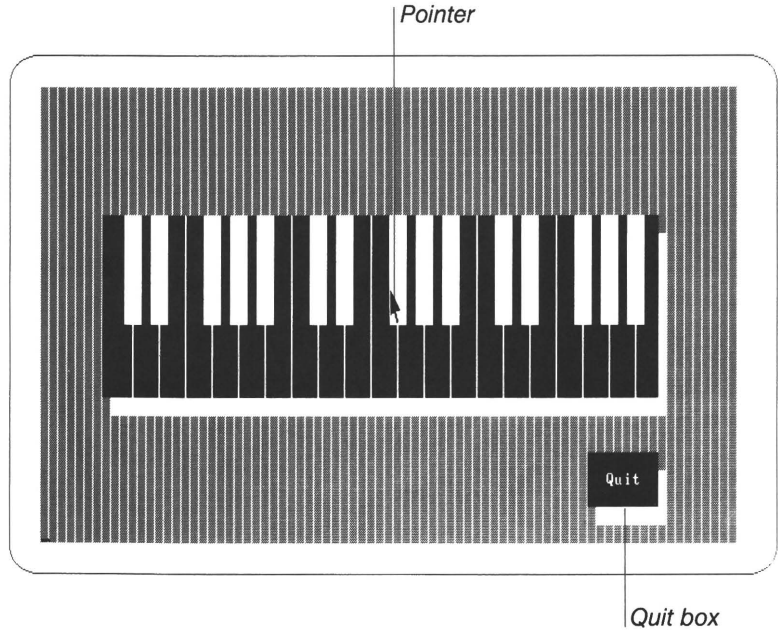

Practicing Piano

Move the pointer from side to side by moving the mouse back and forth across your desk top. When you are comfortable moving the pointer, move the mouse until the pointer rests on any key, then click the left mouse button. The computer responds by playing the note that corresponds to that key. Click the right mouse button, and the computer sounds the same note an octave higher.

Now move the pointer to any key, press either mouse button, and slide the pointer across the keyboard while holding down the mouse button. Your computer sounds a rapid series of notes.

Quitting Piano

When you have finished playing, move the pointer until it rests on the Quit box, and click the left mouse button. The DOS system prompt will appear at the top of your screen.

The Control Panel

Now that you've had some practice using the mouse, you may want to adjust the mouse's *sensitivity level*—the ratio of actual mouse movement to the onscreen pointer movement. Certain programs are more sensitive to mouse movement than others. The Control Panel allows you to control the sensitivity of the pointer to the movement of the mouse so that the sensitivity is appropriate for the program you are running.

When you ran the MSETUP program, you were asked if you wanted to install the Control Panel so that it would be loaded automatically whenever you started your computer. If you answered “yes,” MSETUP modified your AUTOEXEC.BAT file accordingly. To load the Control Panel if you specified that you did *not* want the Control Panel loaded automatically, switch to the drive or directory that contains the mouse program files and type *cpanel* at the DOS prompt.

Whenever you are using the mouse, you can view the Control Panel by pressing CTRL-ALT, and then pressing either mouse button. The following dialog box will appear on your screen:

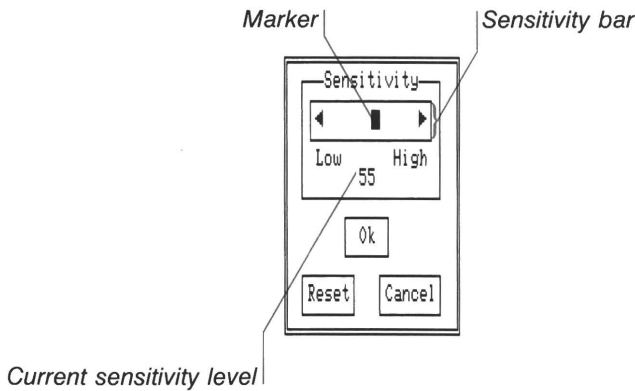

The position of the marker and the number below the sensitivity bar indicate the current sensitivity level. The sensitivity level can vary from 0 to 100. The default level is 50.

Loading the Control Panel

Viewing the Control Panel

4.2 The Control Panel

Changing the mouse sensitivity

To change the mouse sensitivity level:

- 1 Move the pointer to the left arrow on the sensitivity bar if you want to decrease the sensitivity level; move the pointer to the right arrow if you want to increase the sensitivity level.
- 2 Click the left mouse button to move the marker in increments of 5 in the direction indicated by the arrow. Press and hold down the left mouse button to move the marker continuously in the direction of the arrow. The number representing the current sensitivity level changes to reflect the movement of the marker.

Note You also can change the sensitivity level by placing the pointer directly on top of the marker, then holding down the left mouse button as you drag the marker in the desired direction on the sensitivity bar.

- 3 To save the change you've made to the sensitivity level, move the pointer to "OK," then click the left mouse button. (If you don't want to save the change, move the pointer to "Cancel" and click the left mouse button.) The level that you set will remain in effect until you restart your computer.

Resetting the Control Panel

If you want to reset mouse sensitivity to the setting that was in effect prior to the last time you invoked the Control Panel, point to "Reset" and click the left mouse button.

5 Cleaning the Mouse

Your mouse may pick up some dust or lint after an extended period of use. If you notice that the onscreen pointer is not moving smoothly, or that the mouse ball is not moving freely, use this procedure to clean the mouse:

- 1 Turn your computer off.
- 2 Disconnect the mouse cable from your computer.
- 3 Turn the mouse upside down so that the ball is face up.
- 4 Slide the mouse ball cover in the direction marked OPEN and remove the cover. (See Figure 5.1.)

5.1 Removing the Mouse Ball Cover

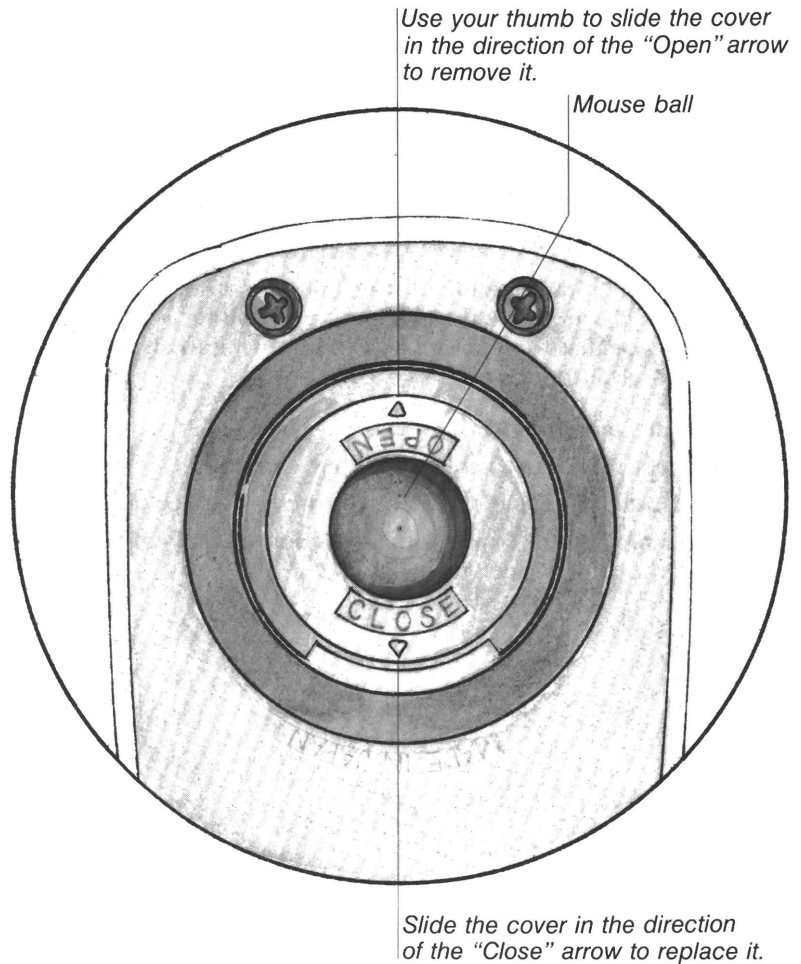

- 5 Turn the mouse right side up. The ball should drop into your hand. If it doesn't, gently shake the mouse until the ball drops out of its socket.
- 6 Once the ball is free, use adhesive tape to pick up the dust and lint on the surface of the ball. Wipe away any dirt or lint inside the mouse socket. If any lint is trapped inside the socket or on the rollers, use a cotton swab dipped in alcohol to loosen it.
- 7 Return the ball to its socket. Snap the mouse ball cover on by sliding it in the direction marked CLOSE. (This will be easier if you first insert the tab on the OPEN end into the slot in the lower-right part of the cover mounting.)
- 8 Reconnect the mouse cable, then turn your computer on.

6 Other Sources of Information

Prewritten Mouse Menu Programs

Microsoft offers prewritten mouse menu programs that enable you to use the Microsoft Mouse with applications that do not normally support the mouse. Some of these menus have been included on the disks labeled "Microsoft Mouse Menus" in your Microsoft Mouse package.

Please let us know if you are interested in receiving information on the additional prewritten mouse menus available, or have suggestions for applications you think would be enhanced by using the Microsoft Mouse. Just add any requests or suggestions to the comment section on the Registration Card that was included in the Microsoft Mouse package.

Mouse Menu Documentation

Each prewritten mouse menu program included in your Microsoft Mouse package has an accompanying online tutorial and quick reference card. If you want to use one of the prewritten mouse menus, first go through its tutorial. To start the tutorial for a prewritten mouse menu, follow the instructions on the menu's quick reference card.

Mouse menu tutorials

Using the Mouse with Other Microsoft Products

You can use the Microsoft Mouse with other Microsoft products, such as Microsoft Windows, Microsoft Word, Microsoft Project (version 2.0), Microsoft Flight Simulator, and Microsoft Multiplan (version 2.0). You should read the documentation that came with each of these products for specific instructions on using the mouse with that program.

Other Microsoft product documentation

**Microsoft Mouse
Programmer's
Reference Guide**

Finding Technical Information

If you want to design your own mouse menu program for an application that does not normally support the mouse, or want to design a mouse interface for one of your own programs, fill out the card that was included in the mouse package and return it to Microsoft. The *Microsoft Mouse Programmer's Reference Guide* includes:

- Instructions for creating your own mouse menu programs
- A description of the interface between the mouse driver and application programs, such as screen modes, graphics and text cursors, and the virtual screen
- Instructions for making mouse system calls from the BASIC Interpreter, Assembly Language programs, and high level languages
- Mouse function descriptions
- Sample source code listings
- A description of the Microsoft Mouse EGA Register Interface

Index

Asynchronous Communications Adapter 9
AT&T 6300 computer, mouse compatibility v
AUTOEXEC.BAT file 17, 18

Ball *See* Mouse

Binary Synchronous Communications Adapter 9

Bus Mouse

- adapter *See* Bus Mouse Adapter
- connection to Bus Mouse Adapter 11
- description 5
- installing 7-12
- interrupts 7-8
- part number 5

Bus Mouse Adapter

- Bus Mouse connection 11
- connector 7
- defined 5
- handling precautions 7
- installing 9-12
- jumper
 - description 7
 - setting 8-9

Cleaning the mouse 29-30

Clicking defined 24

Communications adapters 9

COMPAQ computers, mouse compatibility v

CONFIG.SYS file 18

Control Panel 27-28

Copying

- mouse disks 16
- mouse driver 17-18
- Startup disk 16

CTRL-ALT, Control Panel display 27

Cursor *See* Pointer

Disk copying 16

Display devices, mouse support v

Expansion slot 9-12

Floppy disk system, mouse files copying 17

Graphics display adapters v

Hard disk system, mouse files copying 17

Hercules Graphics Card, mouse support v

Highlighting procedure 24

IBM display devices, mouse support v

IBM Enhanced Graphics Adapter

- Bus Mouse jumper setting 9
- mouse support v

IBM Network Adapter 9

IBM PC computers

- Bus Mouse Adapter installation 9-12
- Bus Mouse jumper setting 9
- mouse compatibility v

InPort Interface connector 14

InPort Mouse

- description 6
- installing 13-14
- part number 5

Installation

- Bus Mouse 7-12
- Bus Mouse Adapter 9-12
- equipment requirements 5
- InPort Mouse 13-14
- Serial Mouse 12-13

Interrupts 7-8

Jumper *See* Bus Mouse Adapter

Loading

- mouse driver 18
- Startup program 16

Menu program 31-32

Microsoft Mouse *See* Mouse

Microsoft products, mouse use with vii, 31

Monochrome display adapters v

Mouse

ball

- cleaning 29-30
- description 24
- removing 29-30

Bus version *See* Bus Mouse

cleaning 29-30

clicking 24

compatible devices v

computer compatibility v

Control Panel 27-28

defined vii

disks copying 16

display devices, support v

driver 17-18

InPort version *See* InPort Mouse

installing

Bus Mouse 7-12

equipment requirements 5

InPort Mouse 13-14

Serial Mouse 12-13

menu programs 31-32

Microsoft products, use with vii, 31

package contents 5

pointer *See* Pointer

Programmer's Reference Guide 32

selecting portions of screen 24

sensitivity level 27-28

Serial version *See* Serial Mouse

setup program 16-19

software *See* Mouse software

space requirements 24

technical information 32

techniques 23-24

tutorial 23

versions 5

Mouse disks copying 16

Mouse driver 17-18

Mouse menu program 31-32

Mouse Programmer's Reference Guide 32

Mouse software

display devices support v

mouse driver 17-18

setup 16-19

MOUSE1 directory 17

Moving the pointer 24

MREADME.DOC file ix

MSETUP program 16-19

Olivetti M24, mouse compatibility v

Package contents 5

Piano demonstration program 25-26

Pointer

description 24

moving 24

sensitivity level adjustment 27-28

Printing MREADME.DOC file ix

Programmer's Reference Guide 32

Reference Guide 32

Selecting portions of screen 24

Sensitivity level 27-28

Serial Mouse

description 6

installing 12-13

part number 5

Software setup 16-19

Startup disk

copying 16

description 15

working copy 16

Startup program

loading 16

mouse disks copying 16

mouse software setup 16-19

Using the Mouse tutorial startup 23

Static electricity discharge 7

Synchronous Data Link Control Communications

Adapter 9

Technical information 32

Tutorial

mouse menu program tutorial 31

Using the Mouse tutorial 23

Using the Mouse tutorial 23

Microsoft Corporation
16011 NE 36th Way
Box 97017
Redmond, WA 98073-9717

Microsoft®