

**MODULAIRE 580 AM/FM
STEREO COMPONENT SYSTEM
CABINET SHEET # 1 (130-1252)
FAXBACK DOC # 10967**

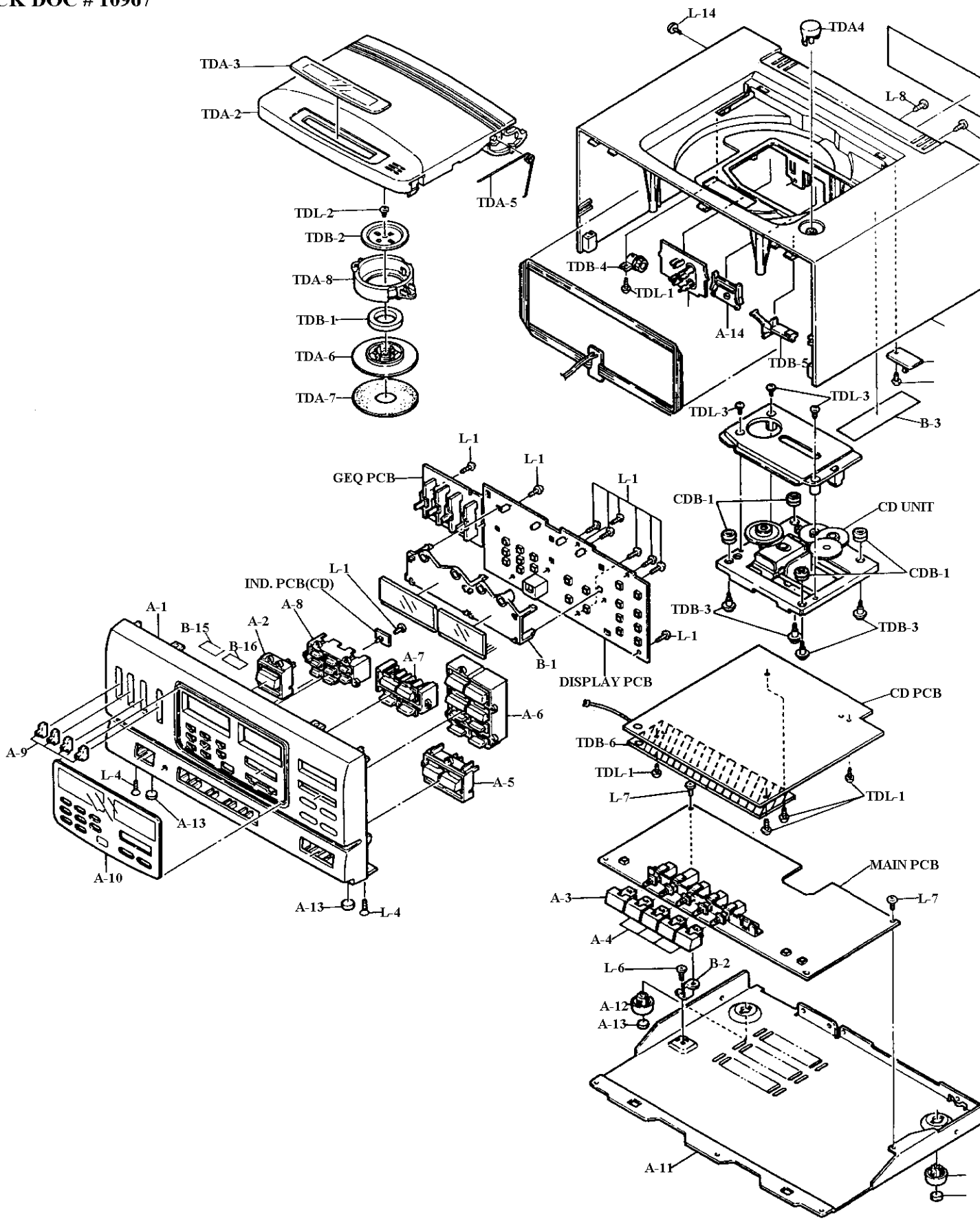

**MODULAIRE 580 AM/FM
STEREO COMPONENT SYSTEM
CABINET SHEET # 2 (130-1252)
FAXBACK DOC # 10967**

