

**MODEL STAV-3450 DIGITAL
SYNTHESIZED AUDIO/VIDEO
SURROUND RECEIVER
SHEET # 1 (310-3031)
FAXBACK DOC # 10811**

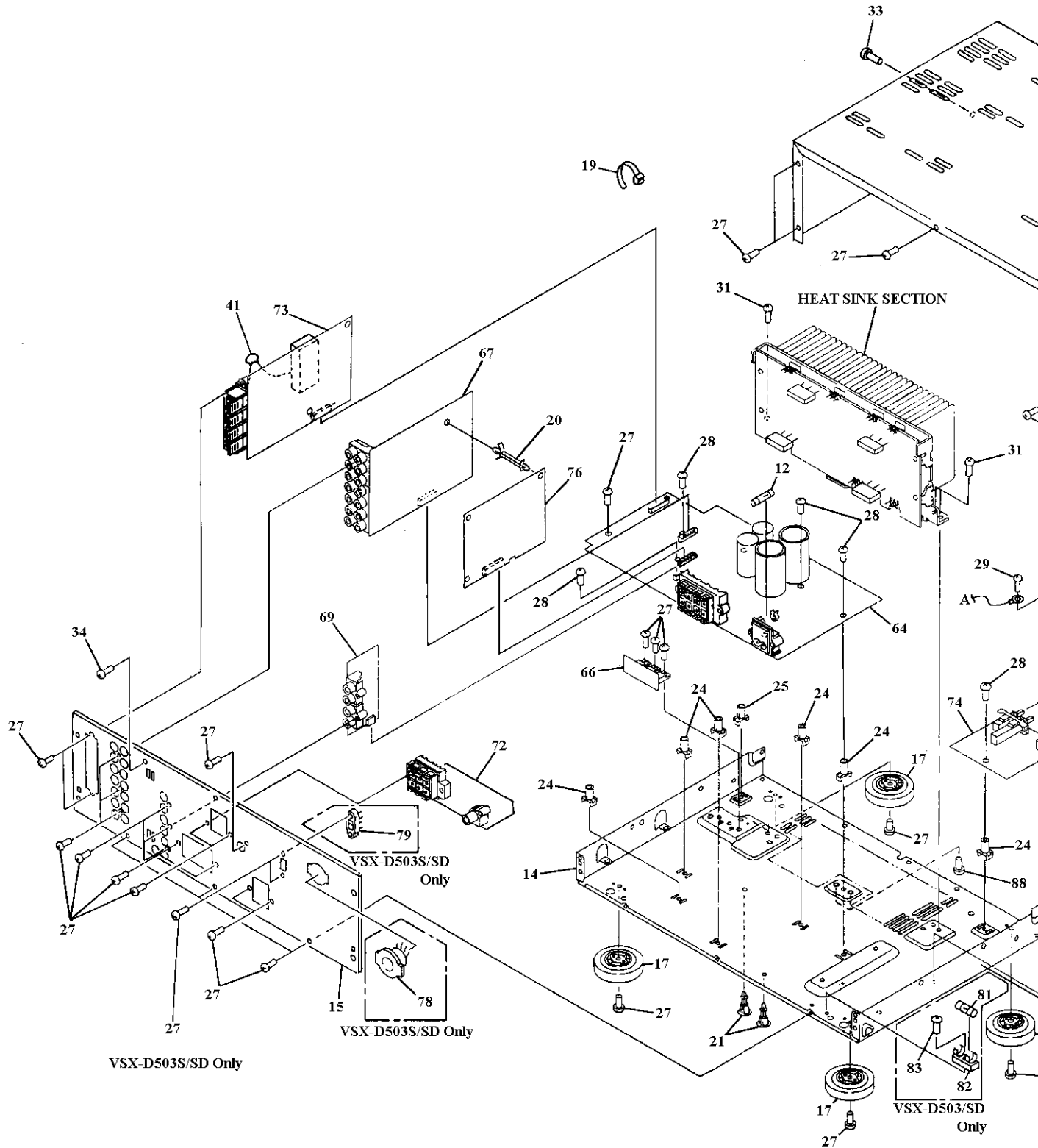

**MODEL STAV-3450 DIGITAL
SYNTHESIZED AUDIO/VIDEO
SURROUND RECEIVER
SHEET # 2 (310-3031)
FAXBACK DOC # 10811**

