

**AMX-16 AMPLIFIED SPEAKER
SYSTEM RIGHT SPEAKER
SHEET #2 (40-1363)
FAXBACK DOC # 10146**

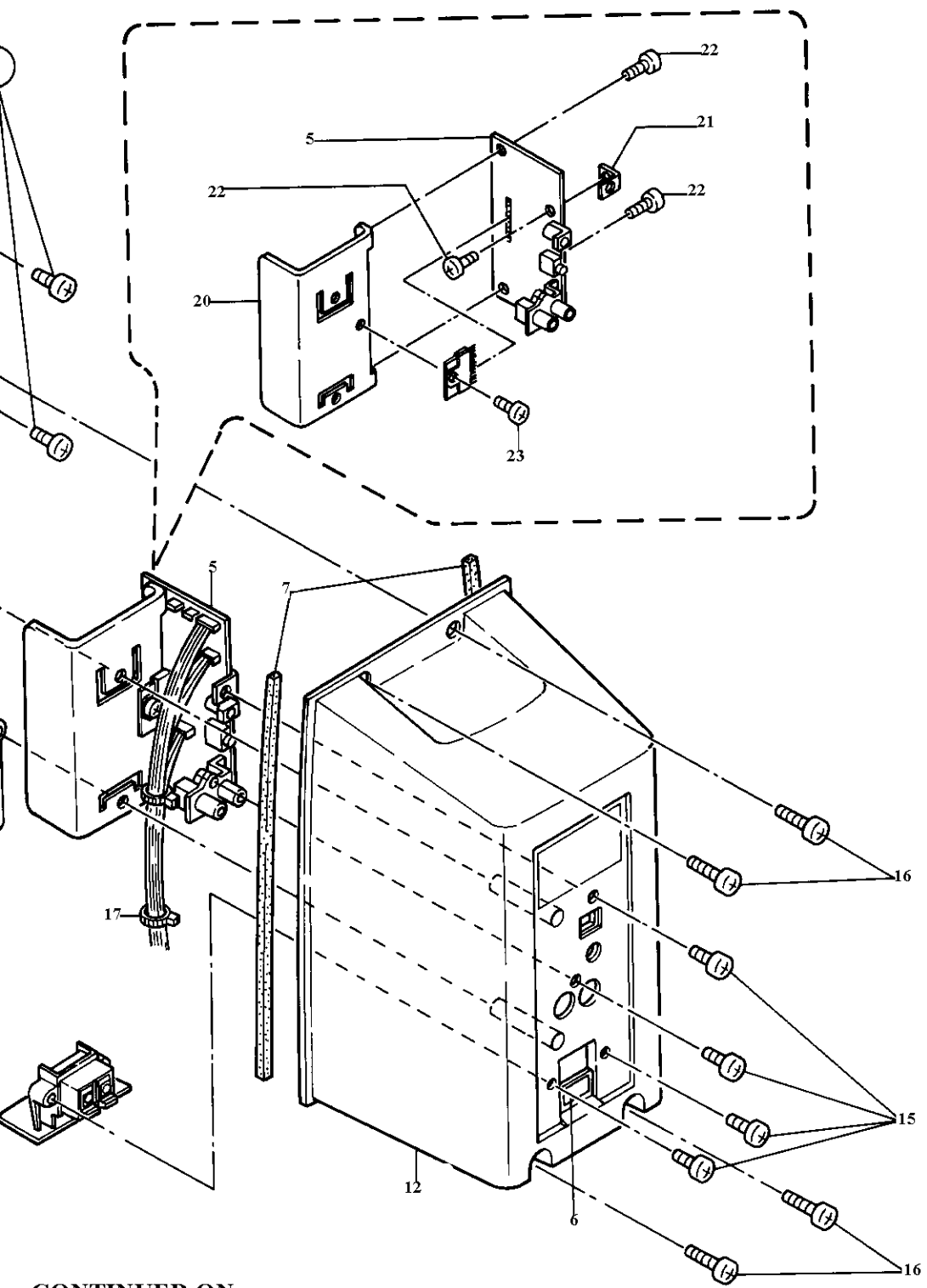

**CONTINUED ON
SHEET # 1**