

Bootable DCS Interface (250-4081)*Use with 20+20 & 20meg Internal

This board uses IRQ# 5

Switch settings (+)=default configuration

Switches #1, #2 set port address:

1 ON	2 ON	340-345 Hex (+)
1 OFF	2 ON	350-355 Hex
1 ON	2 OFF	360-365 Hex
1 OFF	2 OFF	370-375 Hex

Switch #3 selects DMA channel:

3 OFF	DMA Channel 3 (+)
3 ON	DMA Channel 1

Switch #4 selects DMA or Ported Input/Output (PIO):

4 OFF	DMA access (+)
4 ON	PIO

Switches #5,#6,#7 are reserved and remain OFF.

Switch #8 selects the number of drives:

8 OFF	two drives
8 ON	one drive (+)

JB1 selects the ROM memory location for the adapter board.

The ROM can be disabled by placing all 4 jumpers in the lower position.

Settings for MS-DOS

=====

Switch 1, and 2 On, with 3 - 8 Off for the Internal DCS. (1 Drive)

Switch 1, 2, and 8 On with 3 - 7 Off for 20+20 DCS. (2 Drive)

JB1 has 4 columns of 3 jumpers(12 total) Columns 1 & 2 should have the top 2 pins jumped. Columns 3 & 4 should have the bottom 2 pins jumped. ROM memory location CE00:1FFF

MS-DOS version 03.20.XX or greater is REQUIRED!

*Note:New ROM chip for the interface card version 4.48, this is printed on the ROM chip. Also new Tandy.sys driver 4.48 is also needed, the version number will display when the driver is loaded. The new ROM is not a mandatory upgrade for all installations, the ROM is only required if using MS-DOS 3.3.

Settings for XENIX

=====

Switch 1, and 2 On, with 3 - 8 Off for the DCS.

JB1 has 4 columns of 3 jumpers(12 total). Columns 1, 3, and 4 should have the top 2 pins jumped. Column 2 should have the bottom 2 pins jumped. ROM memory location D000:1FFF

Tandy XENIX version 01.00.02 or greater is REQUIRED! (700-3037)

SCO XENIX version 02.02.02 or greater is REQUIRED!+ Drivers (700-1502)

*NOTE: When configuring Xenix you must have the drives turned on or it will not pick them up as available and will not install them in

the Xenix configuration file!!!

TECHNICAL INFORMATION

The information included in this chapter is intended to help optimize the performance of DCS disk drives for special interface board applications. Information about the performance of the drives in the DCS as well as environmental and power requirements is also included here. All the information you need for normal and effective operation of the DCS interface board and utilities is provided in other chapters.

OPTION SWITCH SETTINGS

The option switch settings (See Chapter 1) were set at the factory for the most typical application used with your computer. However, you can change the switch configurations for special applications. Figure 5-1 shows the purpose of each switch.

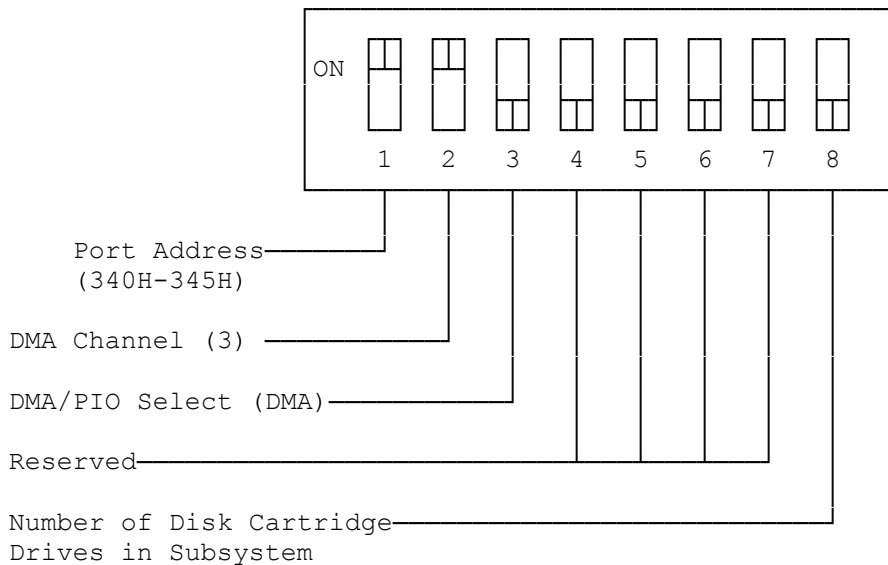

Switches 1 and 2 define the port addresses. You can select one of four groups or port addresses to communicate with DCS systems. The switches were preset at the factory for port addresses 340H through 345H.

NOTE: If you select a new group of port addresses, make certain no conflicts exist with other hardware accessing the same addresses.

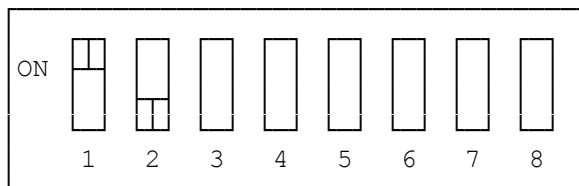

Port 340H-345H
(factory setting)

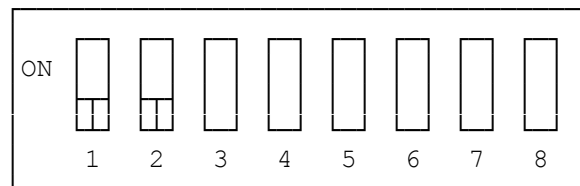

Port 350H-355H

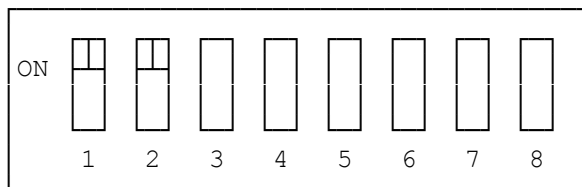

Port 360H-365H

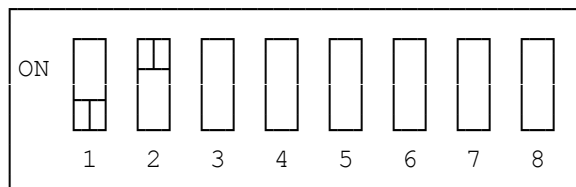

Port 370H-375H

Switch 3 selects the Direct Memory Access (DMA) channel used to communicate with your computer. You can select channel 1 or channel 3. Most networking schemes use channel 1 for communication; so if your computer is part of a network, you should use channel 3.

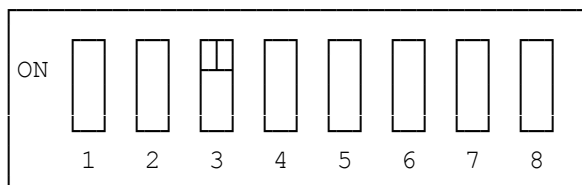

DMA channel 1

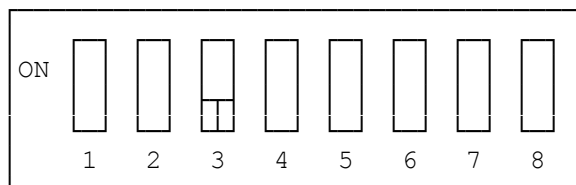

DMA channel 3
(factory setting)

Switch 4 selects DMA or Programmed Input/Output (PIO). Selecting PIO disables DMA communications and decreases transfer rates, but presents problems with other hardware using DMA.

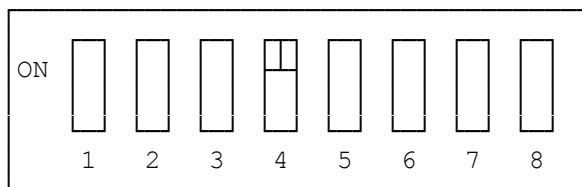

PIO enabled

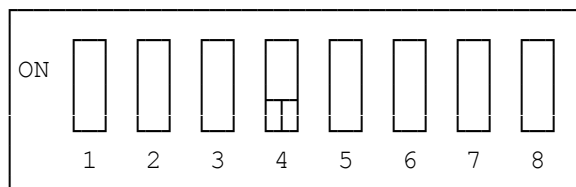

DMA enabled
(factory setting)

Switches 5,6, and 7 are reserved. Do not change these settings.

Switch 8 selects the number of disk drives in your DCS. The switch is set at the factory for two drives.

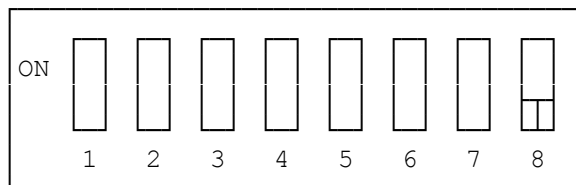
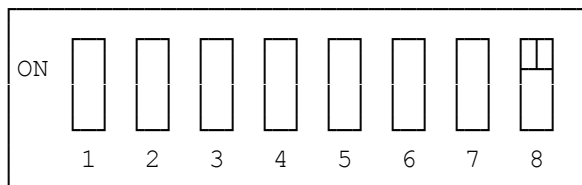

ADDRESS JUMPER SETTINGS

The address jumpers are located on the lower middle of the interface board. the jumpers consist of four connectors that enable you to select the starting address of ROM. The ROM address is the memory location where the

computer finds the DCS interface board. The interface board currently uses 8K of memory; the connectors are installed at the factory to begin that memory at address CE00:0000.

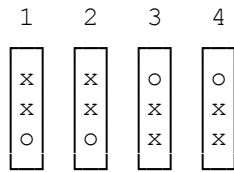

If you move the connectors from one jumper to another, you should be aware of the following possible problems.

- * The interface board will not operate properly without all four jumpers in place on the jumper posts.
- * If any other hardware accesses the same address, conflicts will occur. For example, the Tandy 1200 uses the addresses starting at C800:0000, so if you set the interface board address at that location, your 1200 and DCS drives will not operate. The Tandy 3000 reserves ROM addresses E000 and above. If you set the ROM address jumpers on the interface board at E000 or above, the DCS will not boot and other devices in or on the 3000 may be affected.

Figure 5-7 shows all the addresses that can be accessed by repositioning the address jumpers.

NOTE: Be sure to avoid address conflicts when you change the positions of the connectors!

