

You can increase memory on the main logic board to a total of 40 MB. Bank A supports one 36-bit SIMM. Banks B and C each support four 9-bit SIMMs. The computer requires SIMMs rated at 70ns or faster.

Use memory kits 25-5137, 25-5136, AX-259-7210, and AX-259-7220 to upgrade this machine:

25-5137 contains two 1MB x 9 70ns SIMM chips

25-5136 contains two 4MB x 9 70ns SIMM chips*

AX-259-7210 contains one 1MB x 36 (1 SIMM, 4 MB Total)*

AX-259-7220 contains one 2MB x 36 (1 SIMM, 8 MB Total)*

* Note: The above listed memory chips are available from National Parts.

System Memory Configurations:

NOTE: These computers can come in a variety of configurations.

The configuration will depend on the "build to order" program.

The customer will choose the options, based on a checklist provided at the time of purchase.

The following table shows the number and type of SIMMs required for each memory configuration.

Note: 36 bit SIMM's storage capacity are four (4) times the capacity of a 9 bit SIMM.

Example: a single 1 MB X 36 SIMM will provide 4 MB of memory
 a single 2 MB X 36 SIMM will provide 8 MB of memory

SIMM TYPE TO FILL EACH BANK

TOTAL MEMORY	Bank A (1 x 36 socket)	Bank B (4 x 9 bit Sockets)	Bank C (4 x 9 bit Sockets)
1 MB	(1) 256 KB x 36		
2 MB		(4) 256 KB x 9	(4) 256 KB x 9
2 MB	(1) 512 KB x 36		
4 MB		(4) 1 MB x 9	
4 MB	(1) 1 MB x 36		
5 MB		(4) 1 MB x 9	(4) 256 KB x 9
6 MB	(1) 512 KB x 36	(4) 1 MB x 9	
8 MB	(1) 1 MB x 36	(4) 1 MB x 9	
8 MB	(1) 2 MB x 36		

8 MB		(4) 1 MB x 9	(4) 1 MB x 9
10 MB	(1) 512 KB x 36	(4) 1 MB x 9	(4) 1 MB x 9
12 MB	(1) 1 MB x 36	(4) 1 MB x 9	(4) 1 MB x 9
12 MB	(1) 2 MB x 36	(4) 1 MB x 9	
16 MB	(1) 2 MB x 36	(4) 1 MB x 9	(4) 1 MB x 9
16 MB		(4) 4 MB x 9	
17 MB		(4) 4 MB x 9	(4) 256 KB x 9
18 MB	(1) 512 KB x 36	(4) 4 MB x 9	
20 MB	(1) 1 MB x 36	(4) 4 MB x 9	
20 MB		(4) 4 MB x 9	(4) 1 MB x 9
22 MB	(1) 512 KB x 36	(4) 4 MB x 9	(4) 1 MB x 9
24 MB	(1) 1 MB x 36	(4) 4 MB x 9	(4) 1 MB x 9
24 MB	(1) 2 MB x 36	(4) 4 MB x 9	
28 MB	(1) 2 MB x 36	(4) 4 MB x 9	(4) 1 MB x 9
32 MB		(4) 4 MB x 9	(4) 4 MB x 9
34 MB	(1) 512 KB x 36	(4) 4 MB x 9	(4) 4 MB x 9
36 MB	(1) 1 MB x 36	(4) 4 MB x 9	(4) 4 MB x 9
40 MB	(1) 2 MB x 36	(4) 4 MB x 9	(4) 4 MB x 9

Main Logic Board Layout:

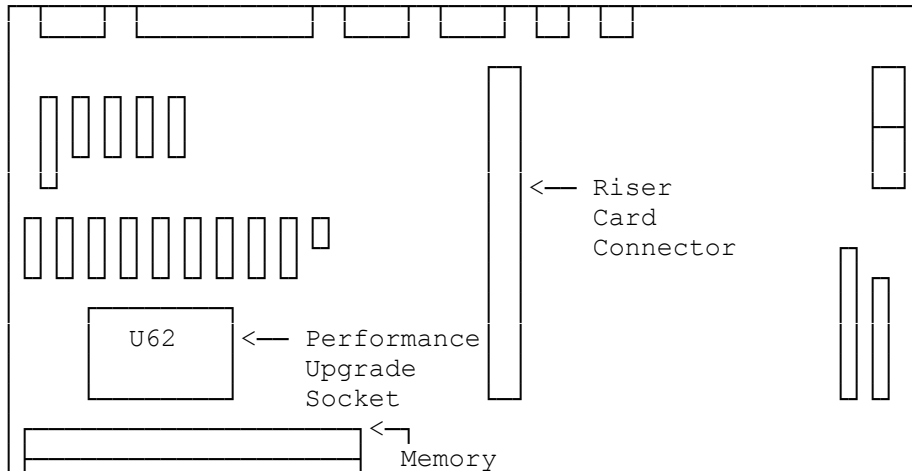

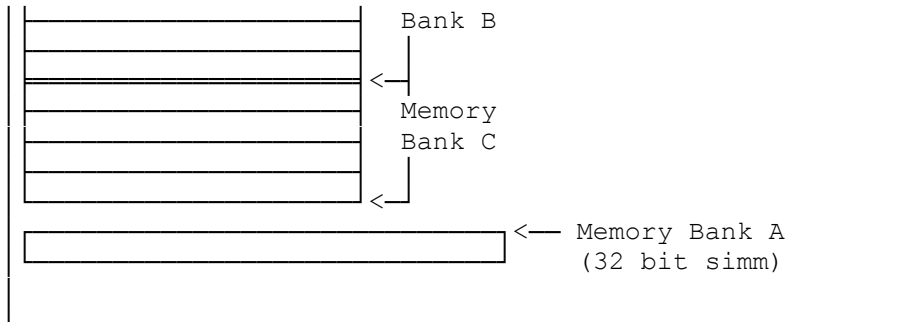

Installing SIMMs:

Note the following before installing SIMMs:

- ° SIMMs installed in Banks B and C must be single-sided, and all four sockets of a bank must be either filled or empty.
- ° Install only one type of SIMM within a single bank.
- ° Retain the antistatic packaging the SIMMs are shipped in, in case you later remove SIMMs.

Before you begin, carefully read the following steps and the documentation provided with the memory kit. To install SIMMs:

1. Turn off the computer, and disconnect all cables.
2. Discharge any accumulated static electricity from your body by touching a grounded metal object. Then, open the computer.
3. Remove any expansion adapters installed in the three-slot expansion area by removing the expansion slot screws, disconnecting any data cables, and gently moving each adapter back and forth while pulling it out of the riser card connector.
4. Install each SIMM in the appropriate socket.
To install a SIMM in Bank A, align the notch in the center of the SIMM with the raised area in the center of the socket. Holding the SIMM by the edges, tilt it to a 45-degree angle from the main logic board. Press the metal-edged connector into the socket, and firmly seat the SIMM. Then, press the top edge of the SIMM toward the retaining clips until the SIMM latches into place.

To install SIMMs in Banks B and C, begin with the socket nearest the back of the computer. Orient each SIMM so that the notched edge of the SIMM is nearer the chassis crossbar. Holding the SIMM by the edges, tilt it to a 45-degree angle from the main logic board. Press the metal-edged connector into the socket, and firmly seat the SIMM. Then, press the top edge of the SIMM toward the retaining clips until the SIMM latches into place.

5. Replace any expansion adapters you removed.
6. Be sure the internal cables are securely connected and do not cause mechanical interference. Then, close the computer.
7. Reconnect all cables.
8. Run the setup* utility to store the new memory value.

* The setup utility is started by pressing F2 during the cpu startup.

Faxback Document # 1775 will provide specific details on running the setup utility.

Removing SIMMs:

Before removing or rearranging SIMMs, be sure the new configuration is a valid configuration. Begin with socket nearest the front of the computer.

To remove a SIMM, open the retaining clips and push the top edge of the SIMM away from the clips until the SIMM is at a 45-degree angle from the main logic board. Then, pull the SIMM away from the board. Store the SIMM in an antistatic package.

Run the setup* utility to store the new memory value.

* The setup utility is started by pressing F2 during the cpu startup.

Faxback Document # 1775 will provide specific details on running the setup utility.

(rjs-06/04/93)