

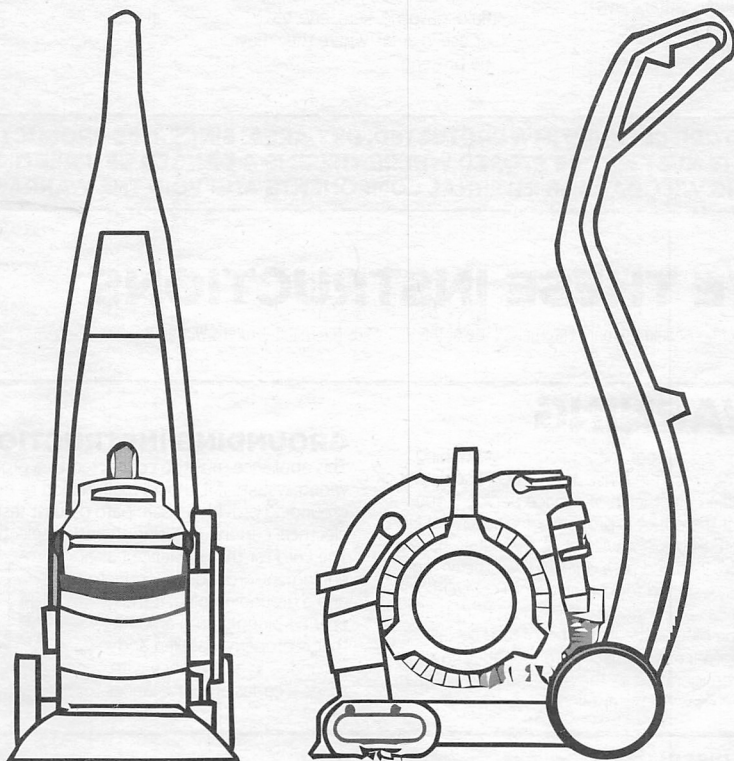

Bissell®

PROHEAT 2X[®] LIFT-OFF[®] Deep Cleaner

USER GUIDE
1560, 1564, 1565 SERIES



IMPORTANT SAFETY INSTRUCTIONS

READ ALL INSTRUCTIONS BEFORE USING YOUR DEEP CLEANER.

When using an electrical appliance, basic precautions should be observed, including the following:

⚠ WARNING

TO REDUCE THE RISK OF FIRE, ELECTRIC SHOCK, OR INJURY:

- » Connect to a properly grounded outlet only. See grounding instructions. Do not modify the 3-prong grounded plug.
- » Do not leave appliance when it is plugged in. Unplug from outlet when not in use and before servicing.
- » Do not expose to rain, store indoors.
- » Do not allow to be used as a toy. Close attention is necessary when used by or near children.
- » Do not use for any purpose other than described in this User's Guide. Use only manufacturer's recommended attachments.
- » Do not use with damaged cord or plug. If appliance is not working as it should, or has been dropped, damaged, left outdoors, or dropped into water, have it repaired at an authorized service center.

- » Do not pull or carry by cord, use cord as a handle, close a door on cord, or pull cord around sharp edges or corners. Do not run appliance over cord. Keep cord away from heated surfaces.
- » Do not unplug by pulling on cord. To unplug, grasp the plug, not the cord.
- » Do not handle plug or appliance with wet hands.
- » Do not put any object into openings. Do not use with any opening blocked; keep openings free of dust, lint, hair, and anything that may reduce air flow.
- » Keep hair, loose clothing, fingers, and all parts of body away from openings and moving parts.
- » Turn off all controls before plugging or unplugging appliance.
- » Use extra care when cleaning on stairs.
- » Do not use to pick up flammable or combustible materials (lighter fluid, gasoline, kerosene, etc.) or use in areas where they may be present.

- » Do not use appliance in an enclosed space filled with vapors given off by oil base paint, paint thinner, some moth proofing substances, flammable dust, or other explosive or toxic vapors.
- » Do not use to pick up toxic material (chlorine bleach, ammonia, drain cleaner, etc.).
- » Do not pick up anything that is burning or smoking, such as cigarettes, matches, or hot ashes.
- » Use only BISSELL cleaning products intended for use with this appliance to prevent internal component damage. See the Cleaning Formula section of this guide.
- » Unplug before connecting TurboBrush Tool.
- » Do not immerse. Use only on surfaces moistened by the cleaning process.
- » Keep appliance on a level surface.
- » Do not carry the appliance while in use.

NOTE: STORE CLEANER IN A PROTECTED, DRY AREA. SINCE THIS PRODUCT USES WATER, IT MUST NOT BE STORED WHERE THERE IS A DANGER OF FREEZING. FREEZING WILL DAMAGE INTERNAL COMPONENTS AND VOID THE WARRANTY.

SAVE THESE INSTRUCTIONS

This model is for household use only. Commercial use of this unit voids the manufacturer's warranty.

⚠ WARNING

Improper connection of the equipment-grounding conductor can result in a risk of electrical shock. Check with a qualified electrician or service person if you aren't sure if the outlet is properly grounded. DO NOT MODIFY THE PLUG. If it will not fit the outlet, have a proper outlet installed by a qualified electrician. This appliance is designed for use on a nominal 120-volt circuit, and has a grounding attachment plug that looks like the plug in the illustration. Make certain that the appliance is connected to an outlet having the same configuration as the plug. No plug adapter should be used with this appliance.

GROUNDING INSTRUCTIONS

This appliance must be connected to a grounded wiring system. If it should malfunction or break down, grounding provides a safe path of least resistance for electrical current, reducing the risk of electrical shock. The cord for this appliance has an equipment-grounding conductor and a grounding plug. It must only be plugged into an outlet that is properly installed and grounded in accordance with all local codes and ordinances.

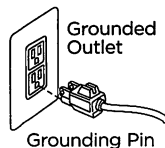

Package Contents

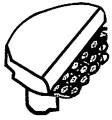

Cleaning Tool

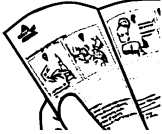

Quick Start Guide



Formula

NOTE: Standard accessories may vary by model. Additional tools may vary - check carton for contents.

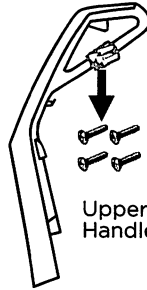

Upper Handle

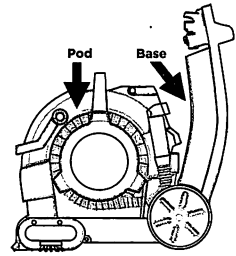

Base Unit

Thanks for buying a BISSELL deep cleaner

We're glad you purchased a BISSELL deep cleaner. Everything we know about floor care went into the design and construction of this complete, high-tech home cleaning system.

Your BISSELL deep cleaner is well made, and we back it with a limited three-year warranty. We also stand behind it with a knowledgeable, dedicated Consumer Care department, so, should you ever have a problem, you'll receive fast, considerate assistance.

My great-grandfather invented the floor sweeper in 1876. Today, BISSELL is a global leader in the design, manufacture, and service of high quality homecare products like your BISSELL deep cleaner.

Thanks again, from all of us at BISSELL.

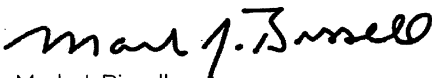

Mark J. Bissell
Chairman & CEO

Safety Instructions.....	2
Product View.....	4
Assembly	5
Cleaning Formulas.....	6
Operations	7-10
Maintenance & Care	11-13
Troubleshooting	14
Warranty.....	15
Service.....	15
Product Registration.....	16
Contact Information	16
Parts & Supplies	16

Product View

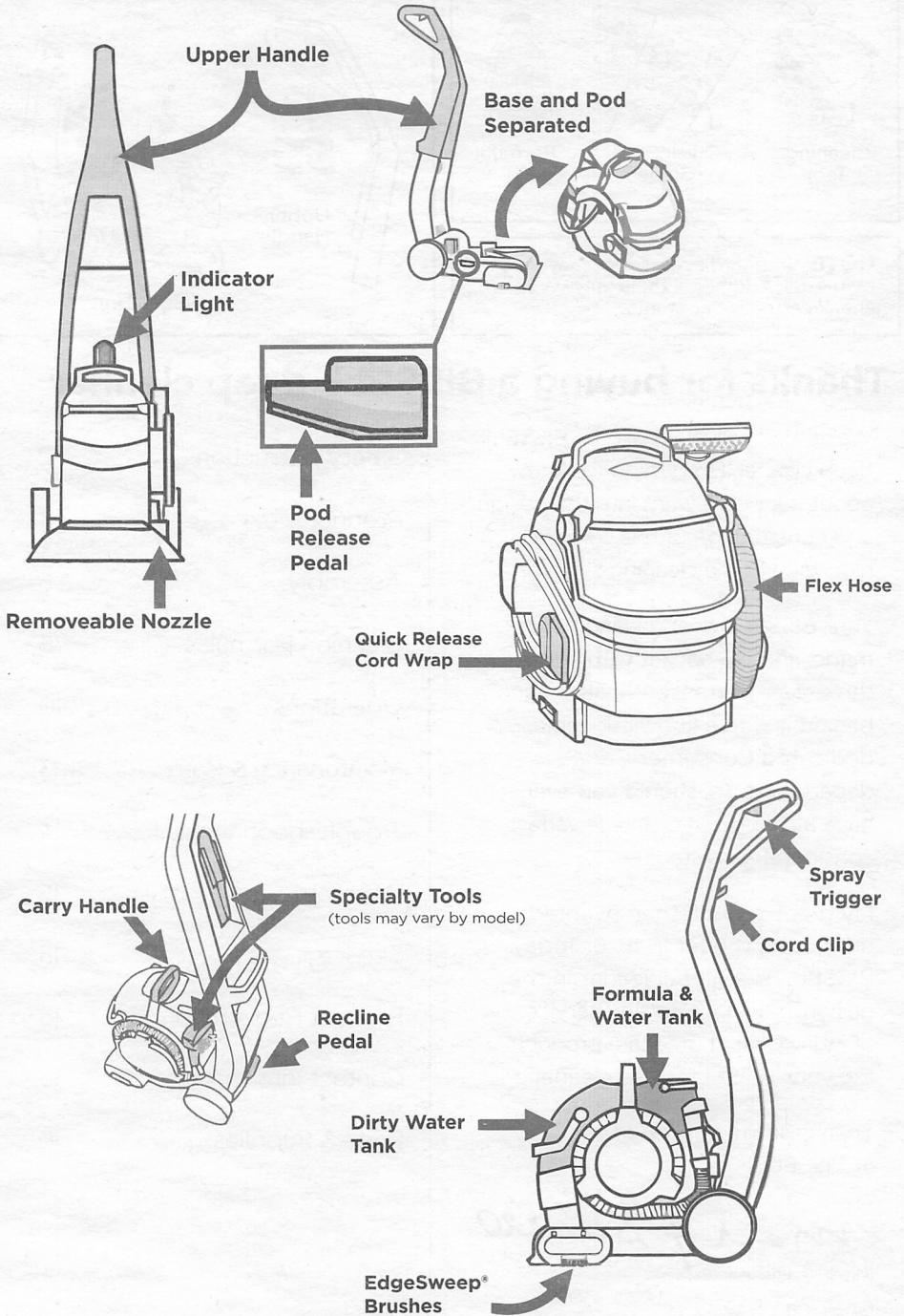

Assembly

⚠️ WARNING

Do not plug in your deep cleaner until you are familiar with all instructions and operating procedures.

Your deep cleaner comes in two easy-to-assemble components:

- Upper handle
- Portable spot cleaner/Base

The only tool you will need to assemble your cleaner is a Phillips screwdriver.



1

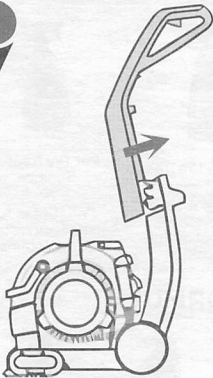

Slide handle into base

2

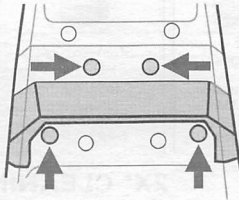

On the back, insert 4 screws in a slight upward angle

3

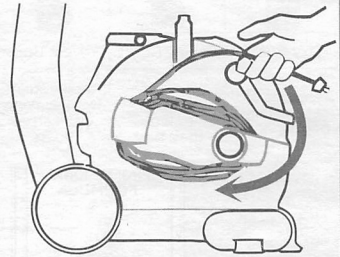

Wrap cord. Unit may come with cord already wrapped.

4

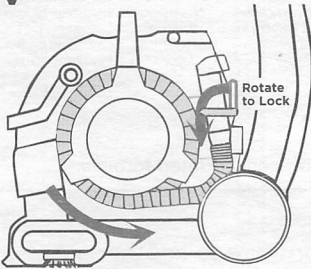

Wrap hose and lock in place by rotating latch

5



Attachments may face forward for best fit.

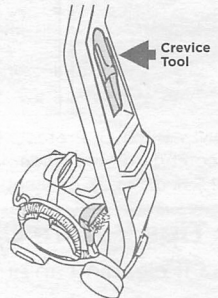

Store attachment(s) - Since attachments vary by model, see carton to see which attachments are included







Cleaning Formulas







⚠️ WARNING

To reduce the risk of fire and electric shock due to internal component damage, use only BISSELL cleaning fluids intended for use with the deep cleaner.

Keep plenty of genuine BISSELL 2X* formula on hand so you can clean and protect whenever it fits your schedule.

Always use genuine BISSELL deep cleaning formulas. Non-BISSELL cleaning solutions may harm the machine and will void the warranty.

BOOST CARPET CLEANING FORMULA ENHANCER				PRETREAT PRE TREAT SPOTS AND STAINS TO IMPROVE CARPET CLEANING PERFORMANCE		
						
Oxy Boost	Renew Boost	Prevent Boost	Pet Oxy Boost	Stain PreTreat	Pet Stain PreTreat	Pet PreTreat + Sanitize
Removes old, set-in stains permanently	Revises carpets to look their best	Repels stains from soaking into carpet fibers	Removes pet stains and odors permanently	Pretreat to penetrate and loosen tough stains	Pretreat to help remove tough pet stains and odors	Penetrates to sanitize and loosen tough stains

easy fill SYSTEM	PROFESSIONAL FORMULA	2X* CLEANING FORMULA				
						
DeepClean + Antibacterial	Professional Deep Cleaning	Pet Stain & Odor	DeepClean & Protect	Allergen Cleansing	DeepClean + Refresh	Deep Clean + Oxy
2-in-1 formula	Out cleans all other formulas <i>Includes Scotchgard™ Protector</i>	Removes tough pet stains and contains patented odor removal technology <i>Includes Scotchgard™ Protector</i>	Deep cleans carpets and protects from future stains with Scotchgard™ Protector	Helps remove pet & pollen allergens	Powerful cleaning with a refreshing scent	Removes deep down dirt, pet stains, & pet odor

ONLY BISSELL Protects from future stains with Scotchgard™ Protector.

Scotchgard™ is a trademark of 3M®.

*2.5 fl. oz. of 2X concentrated formula is equivalent to 5.0 fl. oz. of non-concentrated formula.

Tips Before Carpet Cleaning

- If cleaning an entire room, consider moving your furniture to another area.
- Use a dry vacuum cleaner over area before using your deep cleaner.
- Pre-treat stains with BISSELL PreTreat to improve performance on coffee stains and ground-in dirt.

A note about BISSELL formula

- One of the effective stain removing ingredients in Boost Oxy is Hydrogen Peroxide. Certain people may be affected by the product when it comes into contact with their skin; it may turn the skin white and/or cause tingling. Washing your hands after use and applying hand lotion will remove any possible white discoloration.

Fill Formula & Water Tank: EasyFill

1

Dirty Water Tank

Formula & Water Tank

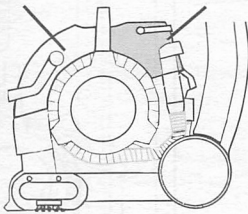

Locate the Formula & Water Tank on the back side of the Pod

2

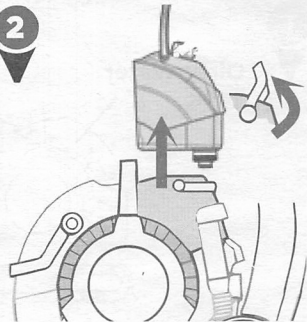

Pull handle up and lift Formula & Water Tank

3

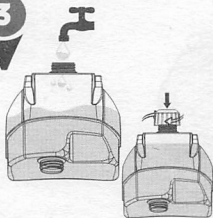

Set tank on flat surface. The tank should rest on the red cap and the plastic edge of the tank. Remove the yellow cap and fill with hot tap water to water line, then replace the cap.

4

easy fill
SYSTEM

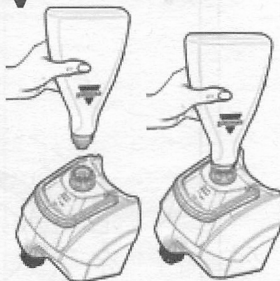

Insert bottle to color-coded opening. Press down and squeeze to add formula to the EasyFill line.

5

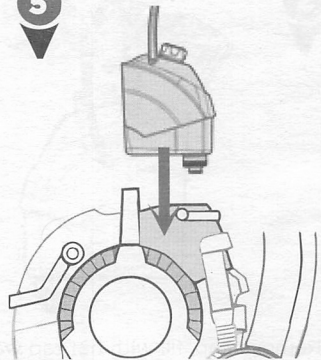

Place the tank back on the unit.

TIP: Attaching the Pod

- When the portable machine is seated correctly, the heated cleaning light will illuminate when you turn the machine on.
- If the heat indicator light does not illuminate, release the pod and re-secure by pushing firmly until both sides snap into place.

NOTE: Fill with hot (140°F/60°C MAX) tap water and add the appropriate BISSELL solution. **DO NOT HEAT WATER OR TANK IN MICROWAVE, OR USE BOILING WATER.**

NOTE: For Easy-Fill Anti-Bacterial cleaning benefits, do not add additional cleaning formulas.

ATTENTION

Do not over wet carpet. Take care not to run over loose objects or edges of area rugs. Stalling brush may result in premature belt failure.

Fill Formula & Water Tank: 2X Formula

1

Dirty Water Tank

Formula & Water Tank

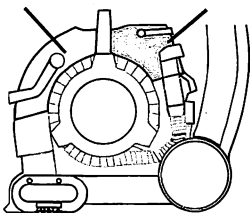

Locate the Formula & Water Tank on the back side of the Pod

2

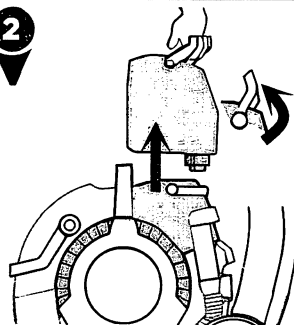

Pull handle up and lift Formula & Water Tank

3

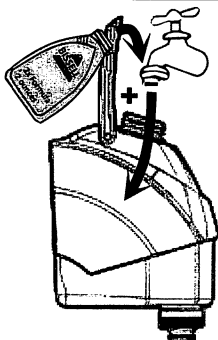

Remove cap, fill with hot tap water to the water line, and add 1.5 oz of 2X formula.

4

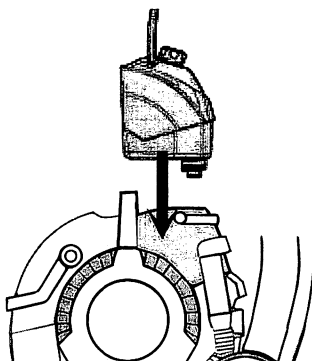

Place the tank back on the unit.

TIP: Before Carpet Cleaning

- Move furniture to another area if cleaning an entire room.
- Use a dry vacuum cleaner over area before using your deep cleaner.
- Pre-treat spots and stains in heavy traffic areas.



Pour in more power with BISSELL Boost

- Fill tank with water and 2X formula (Step 3 above)
- Add 2 ounces of any BISSELL Boost per 1 gallon of water.
- The ProHeat 2X® Lift-Off® Deep Cleaner has a .75 gallon formula + water tank.

NOTE: Fill with hot (140°F/60°C MAX) tap water and add the appropriate BISSELL solution. **DO NOT HEAT WATER OR TANK IN MICROWAVE, OR USE BOILING WATER.** Do not substitute BISSELL 2X Formula cleaning solution with other household cleaning products.

Clean Carpet: Upright Mode

1

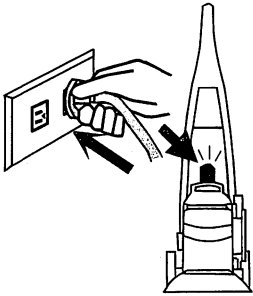

Plug into a properly grounded outlet
Indicator light turns on when unit is plugged in, power switch is pushed and Pod is seated correctly.

2

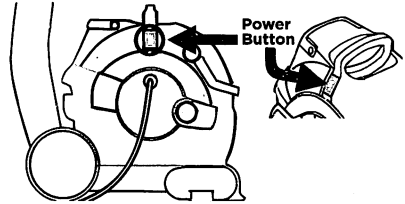

After confirming Formula & Water Tank is filled properly, press the power button, located on the Cord Wrap side

3

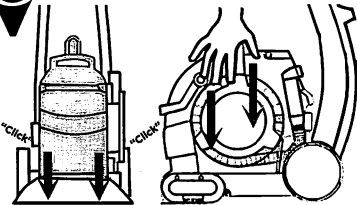

If light doesn't turn on, reset Pod

Listen for two clicks

5

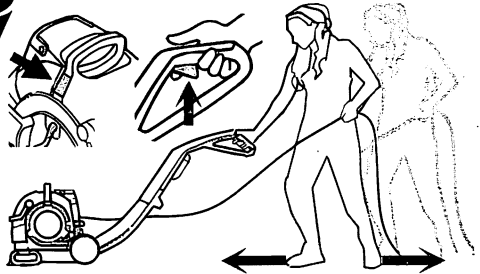

2X Formula

easy fill
SYSTEM

Press the trigger to apply solution. Slowly make 2 wet passes, one forward and one back. Release the trigger to recover the dirty solution by slowly making 2 dry passes, one forward and one back.

Press trigger to apply solution. Slowly make 3 wet passes, one forward, one back and one more forward. Release the trigger to recover the dirty solution by slowly making a final dry pass back.

4

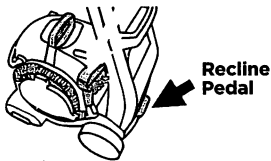

Press recline pedal to release handle.

NOTE: The ProHeat 2X® Lift-Off® Deep Cleaner may be equipped with a circuit breaker that automatically shuts off the brush if a large or loose object catches in the brush roll. If that occurs, unplug your machine, remove the foreign object, and plug the unit back in to reset circuit breaker.

ATTENTION: Some Berber carpets have a tendency to fuzz with wear. Repeated strokes in the same area with an ordinary vacuum or deep cleaner may aggravate this condition.

Clean Carpet: Portable Mode

1

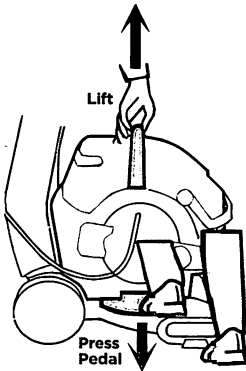

Separate Pod from Base to clean stairs or work on stained areas by stepping on pedal

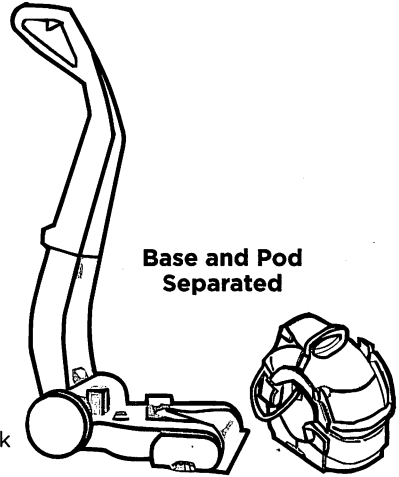

2

Refer to Upright Filling instructions on pages 7 (EasyFill) or 8 (2X Formula)

4

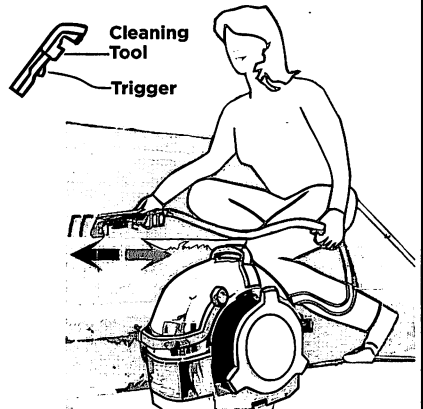

Press the trigger to apply cleaning fluid
Tilt handle slightly up to remove fluids

3

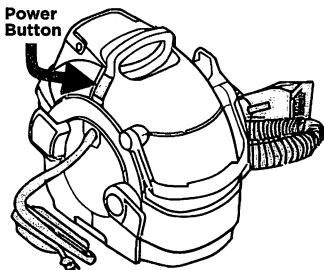

Unwrap cord and plug Pod into outlet
Unwrap the hose and press Power Button to turn unit ON

TIP: Pod Placement

- When cleaning stairs, avoid tripping by placing the Pod on same step on which you are standing or seated.
- Work your way down the stairs, moving the Pod when required.
- Always be aware of where the unit is plugged into the outlet and avoid entanglement.

Maintenance: Empty Dirty Water Tank

⚠️ WARNING

To reduce the risk of fire, electric shock or injury, turn power OFF and disconnect plug from electrical outlet before performing maintenance or troubleshooting.

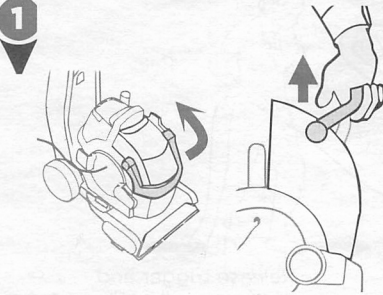

Swivel handle up and lift the Dirty Water Tank away from the Pod

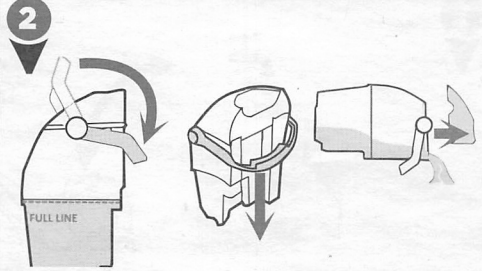

Rotate handle all the way over tank, remove top, pour out dirty water and rinse the Tank

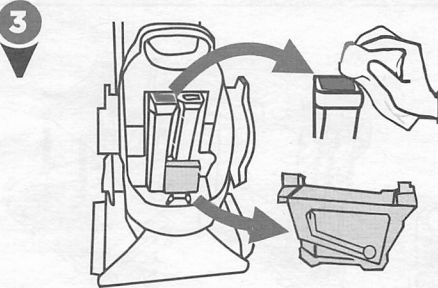

Clean the red filter and clear out any debris in the suction gate

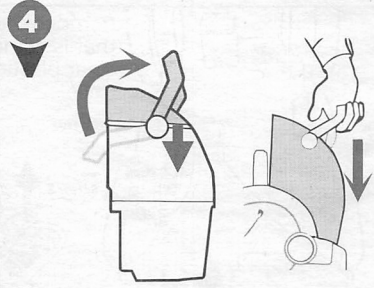

When ready, replace top and reseat the Tank back inside the Pod

NOTE: CLEAN THE MACHINE BEFORE STORING. Fill the Formula & Water Tank with hot tap water and turn on unit. Refer to section Maintenance: Cleaning Machine After Use (page 12) for further details.

Maintenance: Cleaning Machine After Use

⚠️ WARNING

To reduce the risk of electric shock, turn power switch off and disconnect plug from electrical outlet before performing maintenance or troubleshooting checks.

1

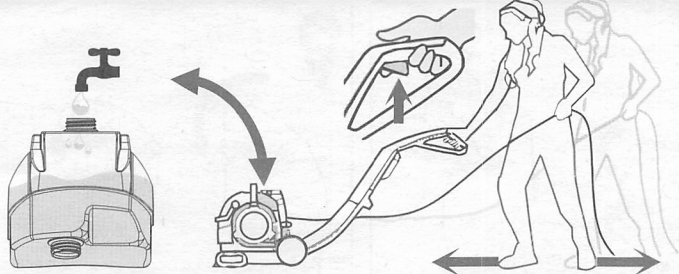

To clean machine before storing it, fill the Formula & Water Tank with hot tap water only, in order to flush out any residual formula

Turn unit on, press and hold the trigger for 15 seconds while making back and forth passes

Release trigger and suction up all of the water

2

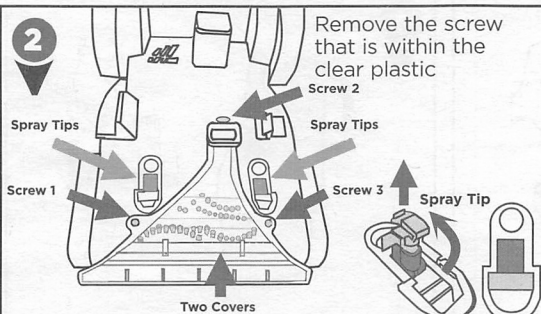

Remove the screw that is within the clear plastic
Screw 2

Remove the pod from the base. Press the tabs on the black ends of the spray tips to remove and rinse off before returning them to the base

Unscrew three screws with a Phillips screwdriver from the clear Brush Rolls covers

Before replacing clear cover, inspect the Brush Rolls and remove any debris

3

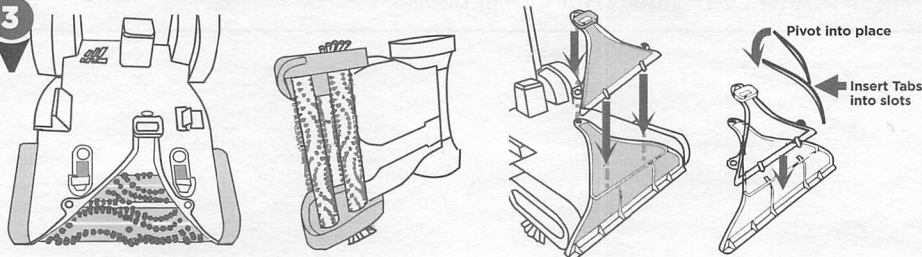

Wipe out the end caps with a clean paper towel

Rinse and replace clear Brush Covers, carefully aligning top cover tabs along front slots of bottom cover

Maintenance: Replacing Small Belt

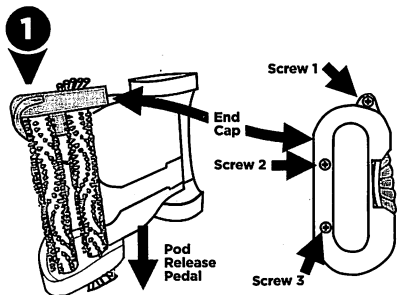

To replace **Small Belt**, flip the Base Unit to the side with the Pod Release Pedal on the bottom

Using Phillips screwdriver, remove three screws from the End Cap and set to side

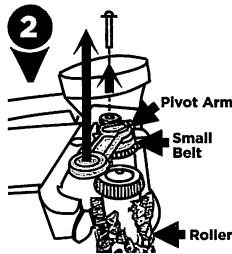

Remove the end cap first. Then, remove the only screw holding Pivot Arm, gently pull off arm to expose Roller ends

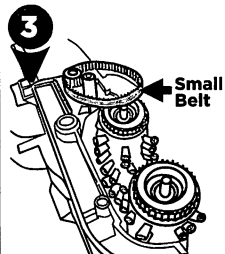

Replace the Small Belt before reversing steps to reassemble Pivot Arm and End Cap

Maintenance: Replacing Large Belts and Rollers

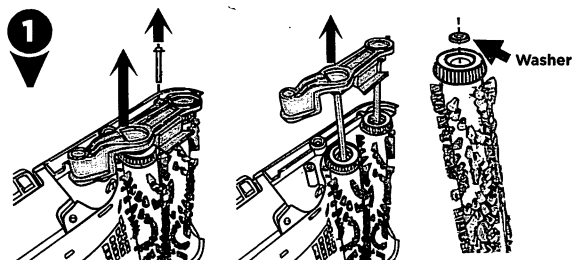

To replace **Large Belt or Rollers**, first remove small belt (see first 3 steps above). Remove the only screw holding Pivot Arm, gently pull off arm with attached Rods

IMPORTANT: Do not lose the small washers held by a magnet at both ends of the Brushroll.

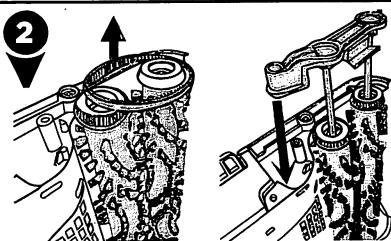

Replace Large Belt or Brush Rollers, as required, carefully reassembling the Rollers and Pivot Arm with attached rods and secure the Pivot Arm with the screw

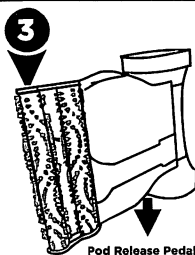

To replace the Small Belt, flip Base Unit with the Pod Release Pedal on the bottom

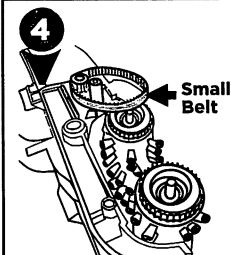

Remove screw to Pivot Arm, replace the Small Belt and reassemble the End Caps

Troubleshooting

WARNING

To reduce the risk of electric shock, turn power switch off and disconnect plug from electrical outlet before performing maintenance or troubleshooting checks.

Problem	Possible causes	Remedies
Heater indicator light does not illuminate	The power is not turned ON	The power must be ON to activate the heater indicator light
	The portable spot cleaner is not attached completely	Make sure the portable spot cleaner is attached. Push down firmly to check (see "Tip: Attaching the Pod" on page 7 OR step 3 of page 9 for detailed instructions)
Reduced spray OR no spray	Formula & water tank may be empty	Refill tank
	Formula & water tank may not be seated completely	Turn power OFF. Remove and reseal tank
	Pump may have lost prime in portable spot cleaning mode	Hold end of hose below water level in tank to prime
	The portable spot cleaner is not attached completely	Make sure the portable spot cleaner is attached. Push down firmly to check (see "Tip: Attaching the Pod" on page 7 OR step 3 of page 9 for detailed instructions)
DirtLifter® PowerBrush does not turn	The portable spot cleaner is not attached completely	Make sure the portable spot cleaner is attached. Push down firmly to check (see "Tip: Attaching the Pod" on page 7 OR step 3 of page 9 for detailed instructions)
	The unit is in the upright position	Brushes only rotate when unit is reclined using the recline pedal
	Circuit breaker on machine (if equipped) may have tripped	Turn the machine OFF and unplug from outlet. Check to see if foreign object is caught in brush roll. Remove object. Plug machine in to reset circuit breaker
	The belt is off or broken	Turn power OFF and unplug unit from outlet. Follow instructions on page 13
Loss of suction power	Tanks may not be seated properly	Pick up both tanks and reseal them so it they fit snugly on the unit
	Nozzles may not be assembled properly	Unplug the unit. Check to make sure the "lip" of the nozzle cover is securely hooked into the groove on the top of nozzle (see page 12)
	The portable spot cleaner is not attached completely	Make sure the portable spot cleaner is attached. Push down firmly to check (see "Tip: Attaching the Pod" on page 7 OR step 3 of page 9 for detailed instructions)
	Dirty tank has picked up maximum amount of dirty water and has reached full line	Empty dirty tank
	Formula & water tank is empty	Check fluid levels in formula & water tank
	Suction Gate is open	Check to make sure the suction gate is closed. Follow "Step 3" on page 11.

Warranty

This warranty gives you specific legal rights, and you may also have other rights which may vary from state to state. If you need additional instruction regarding this warranty or have questions regarding what it may cover, please contact BISSELL Consumer Care by E-mail, telephone, or regular mail as described below.

Limited Three-Year Warranty

Subject to the *EXCEPTIONS AND EXCLUSIONS identified below, upon receipt of the product BISSELL will repair or replace (with new or remanufactured components or products), at BISSELL's option, free of charge from the date of purchase by the original purchaser, for three years any defective or malfunctioning part.

See information below on "If your BISSELL product should require service".

This warranty applies to product used for personal, and not commercial or rental service. This warranty does not apply to fans or routine maintenance components such as filters, belts, or brushes. Damage or malfunction caused by negligence, abuse, neglect, unauthorized repair, or any other use not in accordance with the User's Guide is not covered.

BISSELL IS NOT LIABLE FOR INCIDENTAL OR CONSEQUENTIAL DAMAGES OF ANY NATURE ASSOCIATED WITH THE USE OF THIS PRODUCT. BISSELL'S LIABILITY WILL NOT EXCEED THE PURCHASE PRICE OF THE PRODUCT.

Some states do not allow the exclusion or limitation of incidental or consequential damages, so the above limitation or exclusion may not apply to you.

*EXCEPTIONS AND EXCLUSIONS FROM THE TERMS OF THE LIMITED WARRANTY

THIS WARRANTY IS EXCLUSIVE AND IN LIEU OF ANY OTHER WARRANTIES EITHER ORAL OR WRITTEN. ANY IMPLIED WARRANTIES WHICH MAY ARISE BY OPERATION OF LAW, INCLUDING THE IMPLIED WARRANTIES OF MERCHANTABILITY AND FITNESS FOR A PARTICULAR PURPOSE, ARE LIMITED TO THE THREE YEAR DURATION FROM THE DATE OF PURCHASE AS DESCRIBED ABOVE.

Some states do not allow limitations on how long an implied warranty lasts so the above limitation may not apply to you.

NOTE: Please keep your original sales receipt. It provides proof of date of purchase in the event of a warranty claim.

Service

If your BISSELL product should require service:

Contact BISSELL Consumer Care to locate a BISSELL Authorized Service Center in your area.

If you need information about repairs or replacement parts, or if you have questions about your warranty, contact BISSELL Consumer Care.

Website:

www.BISSELL.com/service-centers

E-mail:

www.BISSELL.com/email-us

Call:

BISSELL Consumer Care

1-800-237-7691

Monday - Friday 8am - 10pm ET

Saturday 9am - 8pm ET

Sunday 10am - 7pm ET

Please do not return this product to the store.

Other maintenance or service not included in the manual should be performed by an authorized service representative.

For any questions or concerns, BISSELL is happy to be of service. Contact us directly at 1-800-237-7691.

Register your product today!

Registering is quick, easy and offers you benefits over the lifetime of your product.

You'll receive:

BISSELL Rewards Points

Automatically earn points for discounts and free shipping on future purchases.

Faster Service

Supplying your information now saves you time should you need to contact us with questions regarding your product.

Product Support Reminders and Alerts

We'll contact you with any important product maintenance reminders and alerts.

Special Promotions

Optional: Register your email to receive notice of offers, contests, cleaning tips and more!

Visit www.BISSELL.com/registration now!

Visit us online at: **BISSELL.com**

When contacting BISSELL, have model number of cleaner available.

Please record your

Model Number: _____

Please record your

Purchase Date: _____

NOTE: Please keep your original sales receipt. It provides proof of purchase date in the event of a warranty claim. See Warranty on page 15 for details.

Parts & Supplies

For Parts and Supplies, go to BISSELL.com and enter your model number in the search field.

We can't wait to hear from you!

We really do read your comments, tweets, and posts.

Rate this product on BISSELL.com

or any of our retailer sites and let us (and millions of your closest friends) know what you think!

For cleaning tips and more visit www.BISSELL.com or find us at:



BISSELL



BISSELLClean



BISSELLClean



BISSELL



BISSELL



©2015 BISSELL Homecare, Inc
Grand Rapids, Michigan
All rights reserved. Printed in China
Part Number 160-8123 Rev 10/15 RevD
Visit our website at: www.BISSELL.com
Scotchgard is a trademark of 3M