

Guidebook for MIDI

MIDI

 Roland

Which Greatly Expands Potential of Musical Composition

GUIDEBOOK FOR MIDI

(The Third Edition)

August 1985

28th Printing November 1987 <B-4>

Printed in Japan

 Roland

Copyright © 1985 by ROLAND CORPORATION

All rights reserved. No part of this publication may be reproduced in any form without the written permission of ROLAND CORPORATION.

Contents

PART 1 What is MIDI?

1.Connections	3
2.MIDI Devices	5
3.Channels	6
4.Modes	8

PART 2 MIDI Messages

1.Channel Messages & System Messages	9
2.Channel Messages	10
3.System Messages	12
4.Function Switches	12

PART 3 MIDI Implimentation

1.Important Notes	13
2.Potentiality of MIDI	14

Introduction

MIDI is an international standard which allows communication of musical performance by means of digital signals. Without MIDI, the communication is limited and difficult. MIDI which is the international standard, enables the connections between the instruments of different manufacturers, and more, MIDI needs only one cable for the set up of two devices.

There are various kinds of MIDI devices on the market, such as synthesizer, sequencer *1, rhythm machine, etc. To make the best use of this useful MIDI, however, good comprehension of MIDI is required. This manual will greatly help you if thoroughly read.

* 1 Sequencer

Equipment which records pitch and timing values sequentially, and makes synthesizers play automatically.

PART 1 What is MIDI?

1.Connections

The MIDI equipped instruments employ 5 pin DIN *2 connectors which are indicated as "IN" "OUT" and "THRU" respectively.

"IN" is a connector for receiving a signal which contains MIDI messages from another MIDI instrument, and "OUT" is for transmitting messages.

The MIDI THRU output is provided to send a direct copy of data coming in MIDI IN.

* 2 DIN
West Germany Industrial Standards. DIN Connectors include 5P (5-pin), 7P (7-pin), etc. with different numbers of pins.

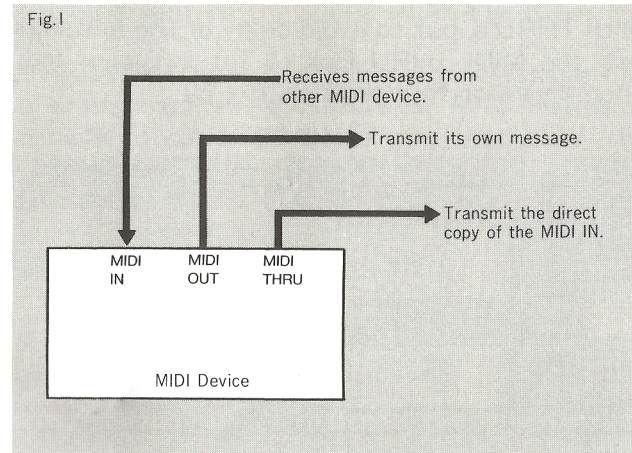
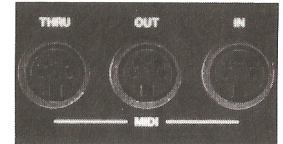

In Fig 2, three MIDI synthesizers A, B and C are set up through MIDI Connectors.

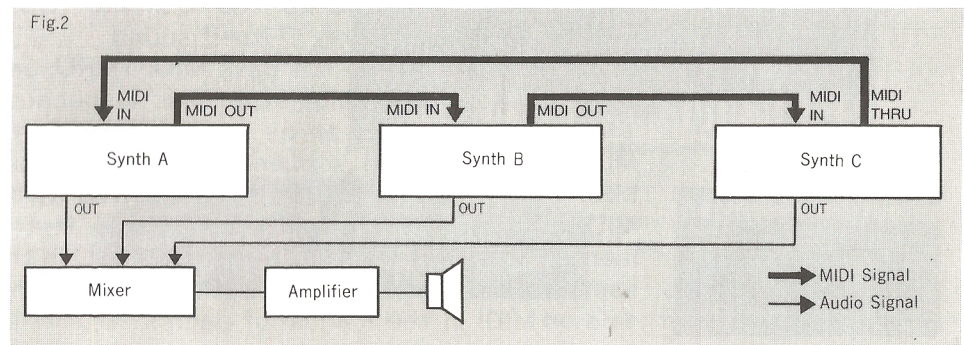

*** 3 MIDI THRU Box**

This is what may be called Channelizer which can distribute messages to several MIDI devices. A MIDI connection cable should not be made forked cord, therefore, to send messages to several MIDI IN's, this unit can be effectively used.

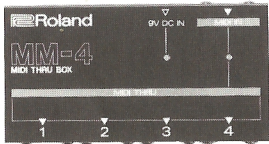

If A is played, the performance messages of A will be sent through its MIDI OUT, and B, which receives the messages, will sound. C does not sound as it is connected to the MIDI OUT of B. This is because the message fed into the MIDI IN is not sent out from MIDI OUT. Therefore, when A is played, only A and B will output sounds. If B is played, B's messages will be sent from the MIDI OUT, making the synthesizer C sound. The C's MIDI THRU will send the direct copy of the messages fed into the MIDI IN, passing the performance messages to A as well. So, playing B will make all A, B and C sound. In other words, MIDI THRU can be used to send the messages to more than one device. Theoretically speaking, as many MIDI devices can be connected using the MIDI THRU's, but to avoid delay of the messages use the MIDI THRU Box *3 for setup of more than three or four devices.(Fig 3)

Fig.3

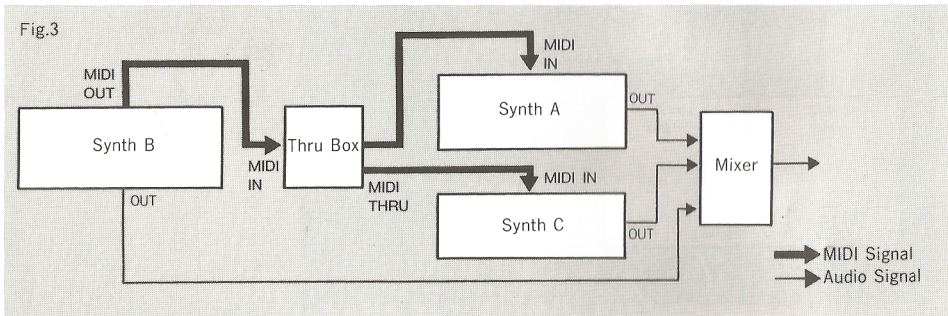

If the synthesizer, C is played, the performance messages of C will not be sent out, as there is no MIDI cable connected to the C's MIDI OUT. Playing C will make only C itself sound. Some MIDI devices do not have MIDI THRU, and some do not have MIDI OUT. This is because they are considered to be unnecessary. Some MIDI keyboards and sequencers, even without MIDI THRU, can send the signal received at its MIDI IN directly to its MIDI OUT. Some instruments can select MIDI OUT or MIDI THRU in the same MIDI Connector. Please read the explanation on MIDI in the manual of each instrument.

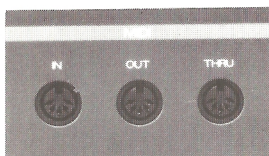

2.MIDI Devices

MIDI has opened a new way for electronic musical instruments. For instance, a synthesizer used to be a single unit, but now, it can be made of two separate parts; the keyboard controller that does not contain sound source section, and the sound module that does not feature the keyboard section. In other words, it is now possible to consider that more than one MIDI instrument makes an electronic instrument component.

Let us take an example. A synthesizer consists of the keyboard and the sound source sections. To obtain a sound from a synthesizer, keyboard information (such as MIDI Note On/Off message) should be sent to the sound source section. (Fig 4)

Using MIDI connection cable, the message can be transferred swiftly. That is, MIDI makes it possible to separate these two section of the synthesizer.(Fig 5)

Fig.4

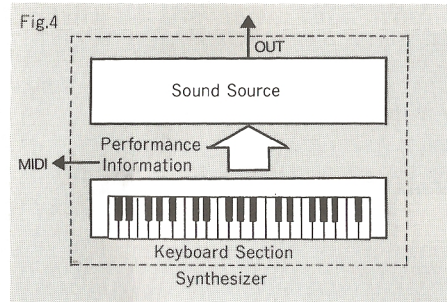
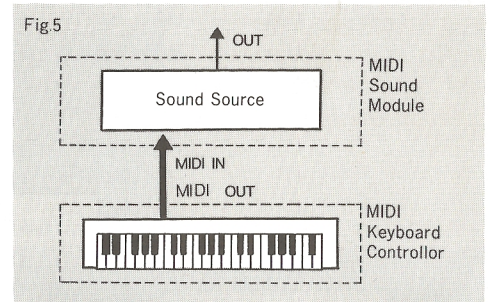
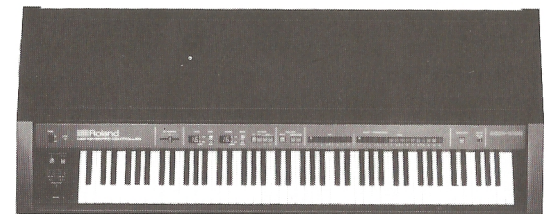

Fig.5



MIDI KEYBOARD CONTROLLER (MKB-1000)



MIDI SOUND MODULE (MKS-7)

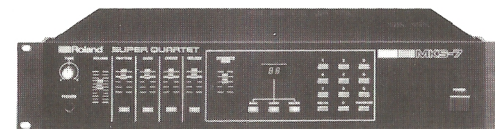

The keyboard section becomes a separate unit; Keyboard Controller, and the sound source section becomes Sound Module.
The Fig 6 shows the position of each MIDI Connector.

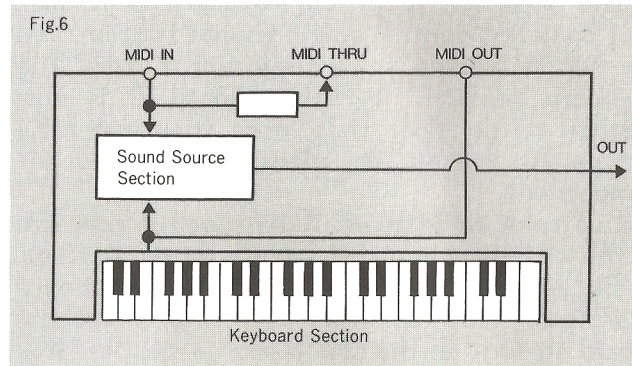

Exactly in the same way, the Fig 7 shows the case of a rhythm machine. The sequencer section is where rhythm patterns are made, and the sound source section where drum voices are stored. The dotted line in the figure is where the sync signal is sent through.

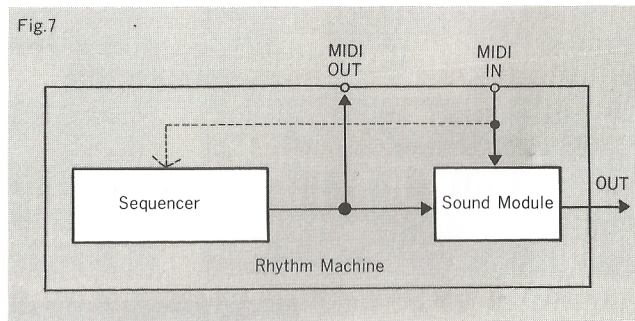

3.Channels(CH)

A single MIDI Cable can transmit different messages to several instruments. This capability comes from the concept of Channels;16 channels of 1 to 16 are available. Depending on which channel of 1 to 16 is set on the receive device, the messages received vary. For instance, in the setup as shown in Fig 8, by changing the channel number of the Mother

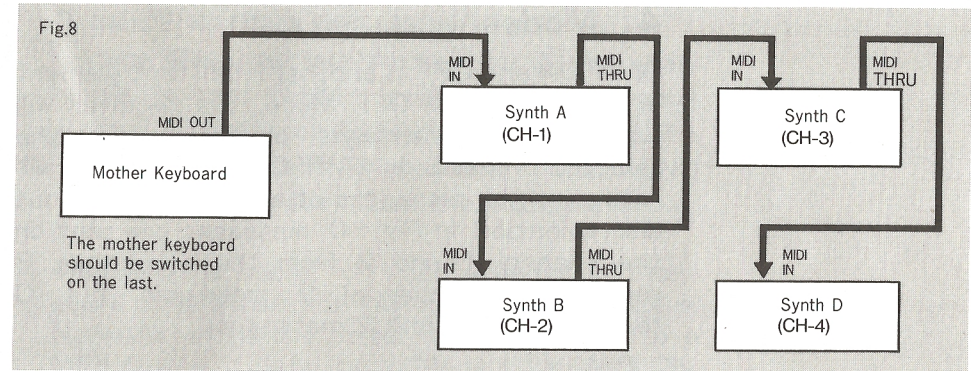

keyboard which is located at the top of connection, any of the connected instruments A to D can be controlled by the mother keyboard. If the performance information is sent on the Channel 1, the synthesizer A will sound, but other synthesizer are silent.

This concept is similar to that when television stations broadcast by transmitting wireless through different channels respectively as shown in Fig 9, a TV set which receives several waves at the same time from one antenna can select any desired broadcasting by switching over the channel selector.

As mentioned earlier, 1 to 16 channels are available, but some devices has a fixed channel. Refer to the owner's manual of each device.

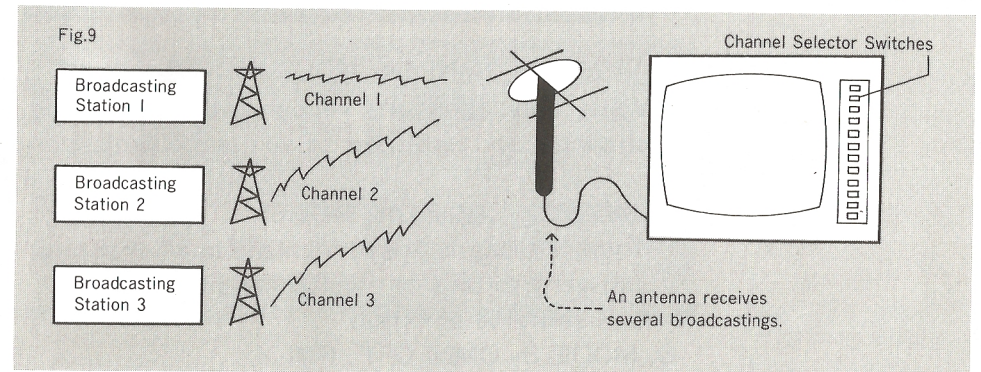

4. Modes

OMNI ON and OFF is another important element of MIDI. In OMNI OFF Mode, the receiver will accept Voice Messages exclusively on the selected channel. In OMNI ON, the receiver will recognize the messages of all channels without discrimination. In Fig 10, messages are sent on the channel 1 and 2 from the sequencer. B receives only channel 2 messages, but C receives both 1 and 2 messages.

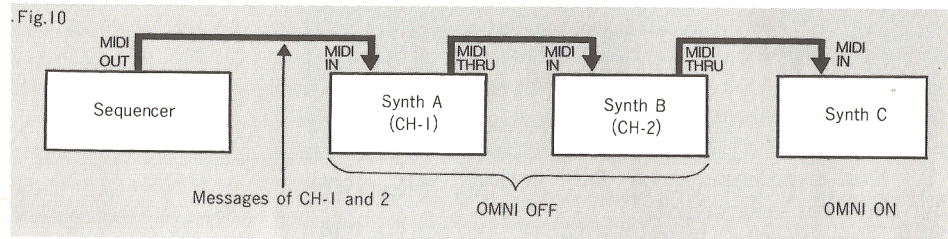

There are 4 receiver's modes with combination of OMNI ON/OFF and Poly/Mono as follows.

Fig.11

	Poly	Mono
OMNI ON	MODE 1	MODE 2
OMNI OFF	MODE 3	MODE 4

A. MODE 1- OMNI ON, POLY

Voice Messages are recognized in all voice channels and assigned to voices polyphonically.

B. MODE 2- OMNI ON, MONO

Voice Messages are recognized in all channels, and control only one voice monophonically. One sound is emitted.

C. MODE 3- OMNI OFF, POLY

Voice Messages are recognized in the Channel Matched to the receiver's channel only, and are assigned to voice polyphonically.

D. MODE 4- OMNI OFF, MONO

Voice Messages are recognized in the channels N thru N+M-1, and assigned monophonically to voice 1 thru M, respectively. The number of voice M is specified in the MONO Mode Message sent from the transmitter.

This mode is useful for when a polyphonic keyboard controls several monophonic synthesizers. Normally, when the power is first applied to a MIDI device, it defaults to Mode 1 (=OMNI ON, POLY Mode) allowing to accept messages of all channels.

PART 2 MIDI Messages

1.Channel Messages & System Messages

There are two kinds of MIDI messages ; one is Channel Messages and another is System Messages. Channel Messages are messages which have channel numbers, such as keyboard performance messages. System Messages have nothing to do with channels, and controls the entire system. System Messages include the messages that synchronize two or more instruments, and the messages which is used exclusively in each individual manufacturer. Let's have a closer look at these messages.

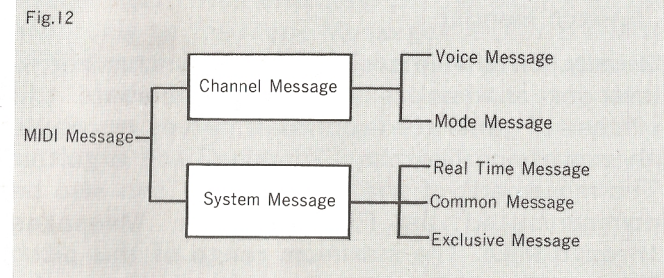

2.Channel Messages

Channel Messages include Voice Messages and Mode Messages.

■Voice Messages (Performance Information)

a.Note On/Off Messages

These most basic MIDI Messages are Note On and Note Off Messages. Note On Message include what key is how hard(velocity amount) pressed, and Note Off is what key is released. All keys have different numbers (key numbers) which can also be assigned to the drum voices of a rhythm machine.

b.Program Change Messages

Many of today's synthesizers can store the tone colors (patch program) in the memory. These patches can be called when required usually by pushing buttons on the panel. The Program Change Messages can also call the patches from memory. This applies to the patch program in the memory of the MIDI effect units as well. Each instrument, however, has a different method of assigning numbers. So, to be able to cope with the patches of all kinds of MIDI devices, MIDI Program Change numbers are simply from 0 to 127. These numbers are differently assigned to the patches of each MIDI instrument. The owner's manual of each instrument will always show how the Program Change numbers correspond to its patches in memory.

c.Pitch Bender

Usually, on the left side of the synthesizer, a lever or a wheel is provided to elevate the pitches of generated sounds. It serves to create an expression like the "choking" on a guitar. The movement of the bender lever can also be communicated as Pitch Bender Messages through MIDI. The maximum range of this pitch bender effect, however, is not included in the Pitch Bender Messages, therefore should be set on each instrument.

d.After Touch

After touching the key in a normal playing manner, you may press the key hard without releasing it. The obtained effect is that the vibrato or brilliance changes. This is called After Touch effect which can also be communicated as a part of MIDI information. Which of the vibrato or brilliance is to be controlled can be selected on each instrument.

e.Control Change

Synthesizers usually have controllers and switches which can be operated during performance. e.g. On/Off of the vibrato, portamento and hold functions, On/Off of the damper or soft pedal of an electronic piano, etc. These actions can be communicated as Control Change Messages through MIDI.

■Mode Messages

The Mode Messages work to select one of the four modes (OMNI ON:POLY, OMNI OFF:POLY, OMNI ON:MONO, OMNI OFF:MONO) which have been explained on page 8. A master MIDI device can change the modes of the slave device. In most of the Roland synthesizers, the receiver defaults to OMNI ON & Poly Mode at power up, then the transmitter sends the OMNI OFF and Poly Messages to the receiver on the set channel. So, first set up the two synthesizers with MIDI cable, and turn the receiver on, then the transmitter. This changes the receiver's mode according to the Mode Messages (POLY & OMNI OFF) transmitted if their channels are matched. The Mode Messages also serve to stop the sound caused by receive error or to internally separate the keyboard from the sound source.

3. System Messages

The System Messages are the messages which can be sent without setting a MIDI Channel. e.g. messages that synchronizes a rhythm machine with a sequencer. The System Messages also include the messages that resolve operation troubles, e.g. when the unit keeps crying because the MIDI cable is disconnected during operation.

MIDI is an international standard, but each manufacturer also has its own messages to remain originality of each product. This is called Exclusive Messages and used in the tone color data of synthesizers or for communication of the sequencer data, etc. Exclusive Messages make it possible to synthesize while watching the monitor display of a computer, and to copy tone color data to other synthesizer. To avoid confusion of the Exclusive Messages among different manufacturers, the idea of ID Numbers is introduced. An ID Number is distributed to each manufacturer, and given to its Exclusive Messages, allowing the connected instrument or computer to recognize it.

4. Function Switches

Although MIDI devices can communicate various kinds of messages, the receiver does not necessarily need to recognize all messages sent from the transmitter. Sometimes it may even be trouble to recognize all. For instance, the After Touch or Pitch Bender Messages consume too much memory when entered into a sequencer. Also, it may be sometimes necessary to ignore the Program Change Messages. In such cases, the Function Switches usually located on the back of the device can be effectively used.

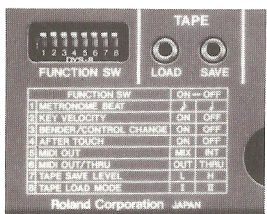
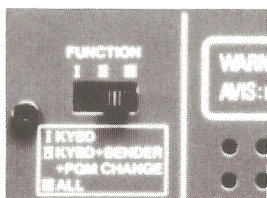

PART 3 MIDI Implimentation

1. Important Notes

MIDI is a super-connection which enables transferring all kinds of musical information by means of a single cord. However, let us provide further description not to cause misoperation.

MIDI Connectors, which are 5 pin DIN, look exactly like DIN Sync*4 connectors. These, however, are completely different things which can never be connected. Please be sure to use a specific MIDI cable, and before connecting the cable to the connectors, turn all the devices off. This is very important to avoid erasing the data of the sequencer or synthesizer.

Different MIDI instruments have different capacity of functions. For example, if one of the connected instruments is an electronic piano with touch sensitivity*5 detecting the key velocity, and the other is a synthesizer without. When the piano is played, both instrument emit sounds, but only the sounds from the piano take on touch sensitivity. However hard the key is played, there is no effect on the synthesizer's sounds. This is because the velocity messages sent from the piano cannot be recognized by the synthesizer. Likewise, when the 16 voice and the 6 voice synthesizers are set up, playing 8 keys on the 16 voice synthesizer will make only 6 notes sound on the 6 voice synthesizer.

* 4 DIN SYNC

This is a synchronizing system developed by Roland. Although the 5 - pin DIN connectors look similar to MIDI, they are only used to transmit signals for synchronization, they cannot be connected to MIDI.



* 5 Touch Sensitivity

Function which detects key touch strength when the keys are pressed. The detected touch is usually used to modify the sounds such as forte, piano, etc.



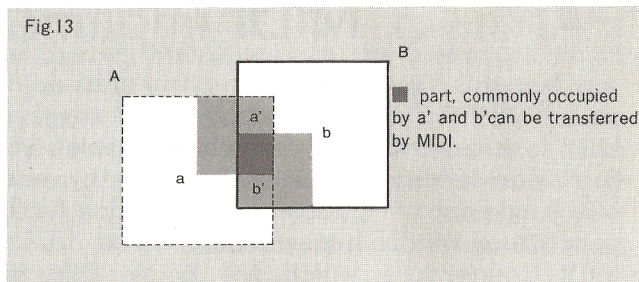

The MIDI messages sent from the transmitter are useless if not recognized by the receiver. In Fig 13, the instrument A has functions "a", and a' are the functions which can be communicated with MIDI. The instrument B has functions "b", and b' are the functions which can be communicated with MIDI. The functions of the overlapped part can be communicated between these two instruments.

2.Potentiality of MIDI

MIDI employs digital signals. That is, MIDI instruments can be set up with a computer. An interface *6, however, is needed between the MIDI instruments and the computer. The interface behaves as an interpreter who understands both the MIDI language and a computer language. e.g. The MIDI Processing Unit MPU-401 has been released from Roland. A host computer plays different roles depending on the software program used, e.g. it becomes a splendid sequencer or a real-time monitor display for synthesizing. (Fig 14) Also, the floppy disks *7 where the program and data can be saved are easy to handle.

*6 Interface

Signal intermediary equipment which is connected in between equipment of different standard or hardware.

*7 Floppy Disk

Flexible magnetic disk which memorizes programs and data.

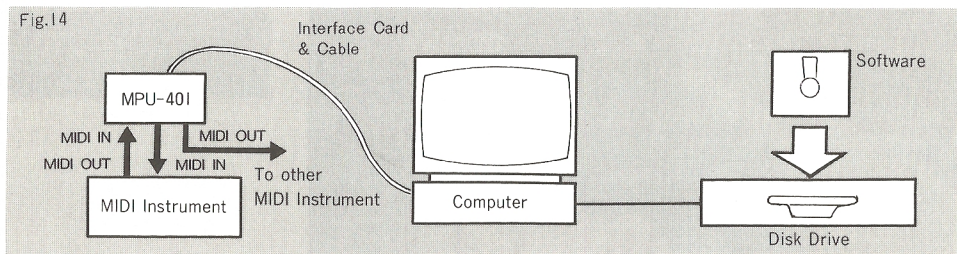

Using an appropriate interface, a MIDI device can be set up with even non-MIDI device. The device that has only DIN connectors can be interfaced with MIDI↔DIN Sync converter, and a CV/Gate type instrument such as module synthesizer requires MIDI↔CV/Gate converter. (Fig 15)

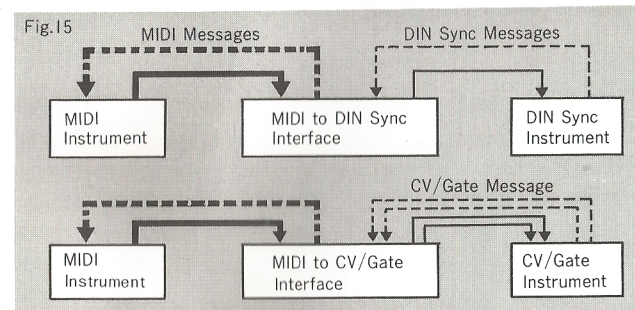

The future of MIDI is full of possibilities not only in the musical field, but also in other fields.

