

Roland

OWNER'S MANUAL

SOUND Canvas

MIDI SOUND GENERATOR SC-55

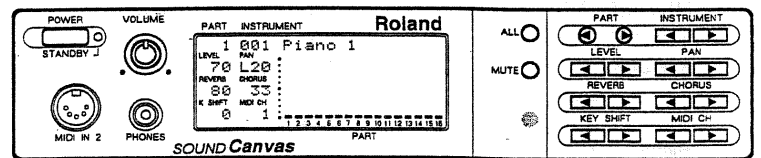

 STANDARD

Information

●When you need repair service, call your local Roland Service Station or the authorized Roland distributor in your country as shown below.

U. S. A.

Roland Corp US
7200 Dominion Circle
Los Angeles, CA. 90040 - 3647
U. S. A.
☎ (213)685 - 5141

CANADA

Roland Canada Music Ltd.
(Head Office)
5480 Parkwood
Richmond B. C., V6V 2M4
CANADA
☎ (604)270 - 6626

Roland Canada Music Ltd.
9425 Transcanadienne
Service Rd. N.,
St Laurent, Quebec H4S 1V3
CANADA
☎ (514)335 - 2009

Roland Canada Music Ltd.
346 Watline Avenue,
Mississauga, Ontario L4Z 1X2
CANADA
☎ (416)890 - 6488

AUSTRALIA

Roland Corporation
(Australia) Pty. Ltd.
(Head Office)
38 Campbell Avenue
Dee Why West. NSW 2099
AUSTRALIA
☎ (02)982 - 8266

Roland Corporation
(Australia) Pty. Ltd.
(Melbourne Office)
50 Garden Street
South Yarra, Victoria 3141
AUSTRALIA
☎ (03)241 - 1254

NEW ZEALAND

Roland Corporation (NZ) Ltd.
97 Mt. Eden Road, Mt. Eden,
Auckland 3
NEW ZEALAND
☎ (09)398 - 715

UNITED KINGDOM

Roland(UK)Ltd.
Rye Close
Ancells Business Park
Fleet
Hampshire GU13 8UY
UNITED KINGDOM
☎ 0252 - 816181

GERMANY

Roland Elektronische
Musikinstrumente
Handelsgesellschaft mbH.
Oststrasse 96,
2000 Norderstedt
GERMANY
☎ 040/52 60 090

BELGIUM/HOLLAND/ LUXEMBOURG

Roland Benelux N. V.
Houtstraat 1
B - 2431 Oevel - Westerlo
BELGIUM
☎ (0032)14 - 575811

DENMARK

Roland Scandinavia as
Langebrogade 6
Box 1937
DK - 1023 Copenhagen K.
DENMARK
☎ 31 - 95 31 11

SWEDEN

Roland Scandinavia as
DanvikCenter 28 A, 2 tr.
S - 131 30 Nacka,
SWEDEN
☎ 08 - 702 00 20

NORWAY

Roland Scandinavia
Avd. Norge
Lilleakerveien 2.
Postboks 95 Lilleaker
N - 0216 Oslo 2
NORWAY
☎ 02 - 73 00 74

FINLAND

Fazer Musik Inc.
Länsituulentie
POB 169
SF - 02101 Espoo
FINLAND
☎ 0 - 43 50 11

ITALY

Roland Italy S. p. A.
Viale delle Industrie 8
20020 ARESE MILANO
ITALY
☎ 02 - 93581311

SPAIN

Roland Electronics
de España, S. A.
Bolivia 239
08020 Barcelona
SPAIN
☎ 93 - 308 - 1000

SWITZERLAND

Musitronic AG
Gerberstrasse 5, CH - 4410
Liestal
SWITZERLAND
☎ 061/921 16 15

Roland CK (Switzerland) AG
Hauptstrasse 21/Postfach
CH - 4456 Tenniken
SWITZERLAND
☎ 061/98 60 55
Repair Service by Musitronic AG

FRANCE

Musikengro
102 Avenue Jean - Jaures
69007 Lyon Cedex 07
FRANCE
☎ (7)858 - 54 60

Musikengro
(Paris Office)
Centre Region Parisienne
41 rue Charles - Fourier,
94400 Vitry s/Seine
FRANCE
☎ (1)4680 86 62

AUSTRIA

E. Dematte & Co.
Neu - Rum Siemens - Strasse 4
A - 6021 Innsbruck Box 591
AUSTRIA
☎ (0512)63 451

GREECE

V. Dimitriadis & Co. Ltd.
2 Phidiou Str., GR 106 78
Athens
GREECE
☎ 1 - 3620130

PORTUGAL

Casa Caius Instrumentos
Musicais Lda.
Rua de Santa Catarina 131
Porto
PORTUGAL
☎ 02 - 38 44 56

HUNGARY

Intermusica Ltd.
Warehouse Area 'DEPO'
Budapest. P.O. Box 3,
2045 Torokbalint
HUNGARY
☎ (1)1868905

ISRAEL

D.J.A. International Ltd.
25 Pinsker St.,
Tel Aviv
ISRAEL
☎ 03 - 283015

BRAZIL

FORESIGHT Corporation
R. Alvarenga 591
CEP - 05509 Sao Paulo
BRAZIL
FAX: (011)210 - 0286

HONG KONG

Tom Lee Music Co., Ltd.
Service Division
22 - 32 Pun Shan Street,
Tsuen Wan,
New Territories,
HONG KONG
☎ 415 - 0911

SINGAPORE

Swee Lee Company
Bras Basah Complex #03 - 23
Singapore 0178
SINGAPORE
☎ 3367886

THAILAND

Theera Music Co., Ltd.
330 Verng Nakorn Kasem, Soi 2
Bangkok 10100,
THAILAND
☎ 2248821

MALAYSIA

Syarikat Bentley
No.142, Jalan Bukit Bintang
55100 Kuala Lumpur
MALAYSIA
☎ 2421288

INDONESIA

PT Galestra Inti
Kompleks Perkantoran
Duta Merlin Blok C/59
Jl. Gajah mada No.3 - 5
Jakarta 10130
INDONESIA
☎ (021) 354604, 354606

TURKEY

Barkat Sanayl ve Ticaret
Siraselviler Cad. 86/6 Taksim
Istanbul
TURKEY
☎ 149 93 24

CYPRUS

Radex Sound Equipment Ltd.
17 Panteli Katelari Str.
P.O.Box 2046, Nicosia
CYPRUS
☎ 453426, 466423

As of FEB 14. 1991

□ Introduction

Thank you for purchasing the Roland SC-55 Sound Canvas Sound Module. The Sound Canvas is a MIDI sound module that contains a wide variety of high quality sounds. In order to take full advantage of the SC-55's capabilities, and to enjoy long and trouble-free service, please read this manual carefully before use.

□ Main Features

- The Sound Canvas is a GS Standard sound source that is newly introduced by Roland. GS Standard was created in an attempt to standardize the way in which sound sources are used. Devices that conform to GS Standard will have the GS Standard mark on their panel.
Song data that was created by using a GS Standard device can be played on any other GS Standard compatible device.
- The Sound Canvas contains a variety of high quality musical instrument sounds and a complete drum set.
- The Sound Canvas is housed in a convenient half-rack size enclosure. Its compact size takes up little space in your effects rack and allows for easy transportation.
- Sound Canvas can function as a complete 16 part multi-timbral sound module.
- By using the internal reverb and chorus effects, it is easy to reproduce the acoustic ambience of a concert hall.
- A variety of system information can be displayed in the large display screen, including the volume level of each instrument. The large panel buttons allow for easy operation.
- The Sound Canvas comes complete with a remote control unit.
- A MIDI IN connector is provided on both the front and rear panels making it easy to connect external MIDI devices.
- An Audio Input jack is provided allowing you to mix the output of other sound modules with that of the Sound Canvas. The signal of both units will be output from the Audio Output jacks.

© Copyright 1991 by Roland

All rights reserved. No part of this publication may be reproduced in any form without the permission of Roland Corporation.

□ CONTENTS

PRECAUTIONS

IMPORTANT NOTES	4
FRONT AND REAR PANELS	5
CONNECTIONS	6
TURN THE POWER ON	9
HOW TO USE THE REMOTE CONTROL	10

LISTENING TO ROM PLAY

BASIC PROCEDURES

PLAYING THE VARIOUS INSTRUMENTS	14
CHANGING THE VOLUME LEVEL/PAN	15
HOW TO ADJUST REVERB/CHORUS	16
HOW TO TRANSPOSE ALL (KEY SHIFT)	17
SELECTING INSTRUMENTS	18
HOW TO SELECT THE DRUM SET	20
PLAYING THE SOUND CANVAS USING A DRUM PAD	22
SETTING THE PART	23

CONVENIENT PROCEDURES

MUTE	25
MONITORING THE SOUND OF A PART	26
TUNING TO THE PITCH OF ANOTHER INSTRUMENT	27
ADJUSTING THE CONTRAST OF THE DISPLAY	28
HOW TO SET THE BAR DISPLAY (Bar display/Peak hold)	29
SETTING THE SOUND CANVAS TO THE SOUND ARRANGEMENT OF THE MT-32	31
MAKING THE BASIC GS STANDARD FORMAT	33
RETURNING TO FACTORY PRESET	34

FOR IMPROVED PERFORMANCE

CHANGING THE MIDI RECEIVE CHANNEL (PART)	35
CHANGING THE TYPE OF REVERB AND CHORUS	36
CHANGING THE WAY THE SOUND IS OUTPUT	37
HOW TO USE PARTS FOR ENSEMBLE PERFORMANCE (Partial reserve)	40
SELECTING INSTRUMENT VARIATION	42
ALTERING THE SOUND	47
STORING THE SOUND CANVAS'S SETTINGS TO A SEQUENCER	50

APPENDIX

TROUBLESHOOTING	56
ERROR MESSAGES	57
ABOUT MIDI	58
ABOUT GS STANDARD	61
TABLE OF OPERATIONS	63
INSTRUMENT TABLE	66
DRUM SET TABLE	70
ROLAND EXCLUSIVE MESSAGES	72
MIDI IMPLEMENTATION	74
SPECIFICATIONS	86

IMPORTANT NOTES

Be sure to use only the adaptor supplied with the unit. Use of any other power adaptor could result in damage, malfunction, or electric shock.

Power Supply

- When making any connections with other devices, always turn off the power to all equipment first; this will help prevent damage or malfunction.
- Do not use this unit on the same power circuit with any device that will generate line noise, such as a motor or variable lighting system.
- The power supply required for this unit is shown on its nameplate. Ensure that the line voltage of your installation meets this requirement.
- Avoid damaging the power cord; do not step on it, place heavy objects on it etc.
- When disconnecting the AC adaptor from the outlet, grasp the plug itself; never pull on the cord.
- If the unit is to remain unused for a long period of time, unplug the power cord.

Placement

- Do not subject the unit to temperature extremes (eg. direct sunlight in an enclosed vehicle). Avoid using or storing the unit in dusty or humid areas or areas that are subject to high vibration levels.
- Using the unit near power amplifiers (or other equipment containing large transformers) may induce hum.
- This unit may interfere with radio and television reception. Do not use this unit in the vicinity of such receivers.
- Do not expose this unit to temperature extremes (eg. direct sunlight in an enclosed vehicle can deform or discolor the unit) or install it near devices that radiate heat.

Maintenance

- For everyday cleaning wipe the unit with a soft, dry cloth (or one that has been slightly dampened with water). To remove stubborn dirt, use a mild, neutral detergent. Afterwards, be sure to wipe the unit thoroughly with a soft, dry cloth.
- Never use benzine, thinners, alcohol or solvents of any kind, to avoid the risk of discoloration and/or deformation.

Additional Precautions

- Protect the unit from strong impact.
- Do not allow objects or liquids of any kind to penetrate the unit. In the event of such an occurrence, discontinue use immediately. Contact qualified service personnel as soon as possible.
- Never strike or apply strong pressure to the display.
- A small amount of heat will radiate from the unit, and thus should be considered normal.
- Before using the unit in a foreign country, consult with qualified service personnel.
- Should a malfunction occur (or if you suspect there is a problem) discontinue use immediately. Contact qualified service personnel as soon as possible.
- To prevent the risk of electric shock, do not open the unit or its AC adaptor.

Memory Backup

- The unit contains a battery which maintains the contents of memory while the main power is off. The expected life of this battery is 5 years or more. However, to avoid the unexpected loss of memory data, it is strongly recommended that you change the battery every 5 years. Please be aware that the actual life of the battery will depend on the physical environment (especially temperature) in which the unit is used. When it is time to change the battery, consult with qualified service personnel.
- When the battery becomes weak the following message will appear in the display: "Battery Low!". Please change the battery as soon as possible to avoid the loss of memory data.
- Please be aware that the contents of memory may at times be lost; when the unit is sent for repairs or when by some chance a malfunction has occurred. Important data should be stored in another MIDI device (eg. a sequencer), or written down on paper. During repairs, due care is taken to avoid the loss of data. However, in certain cases, (such as when circuitry related to memory itself is out of order) we regret that it may be impossible to restore the data.

FRONT AND REAR PANELS

PRECAUTIONS

● Front Panel

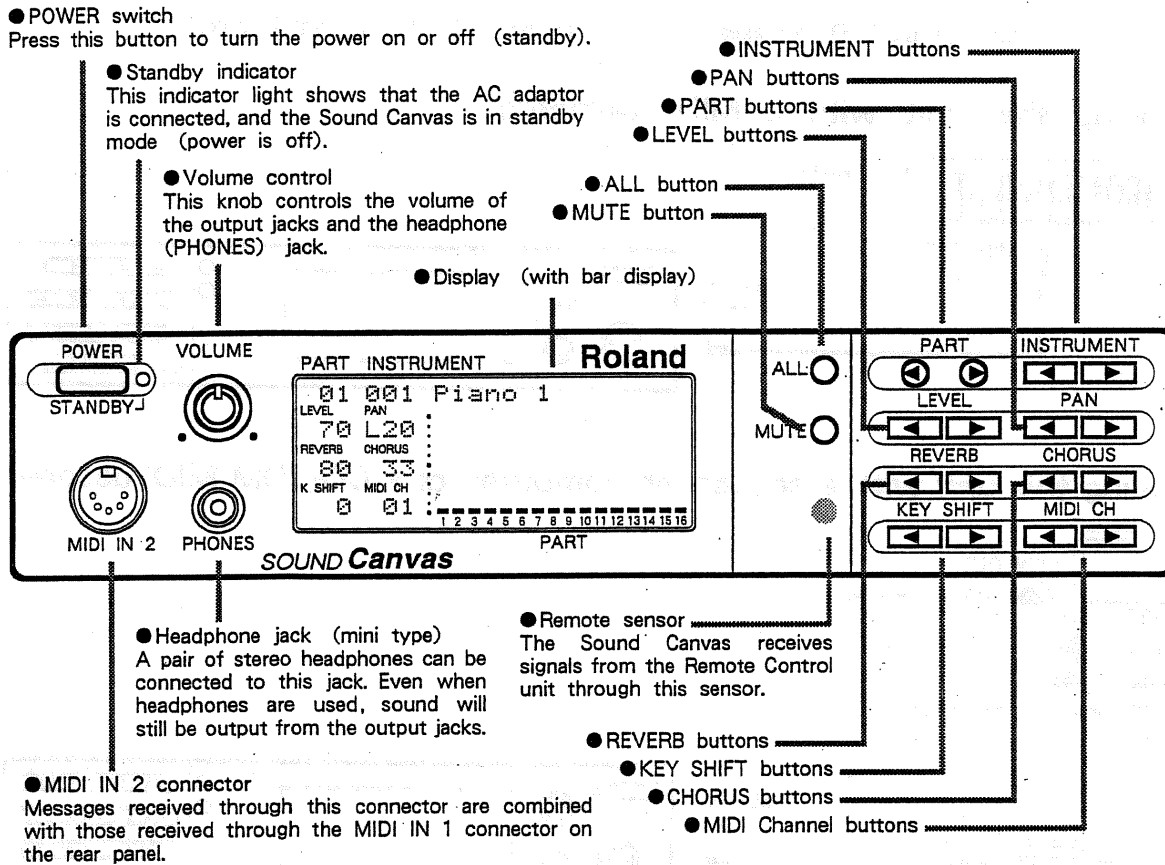

● Rear Panel

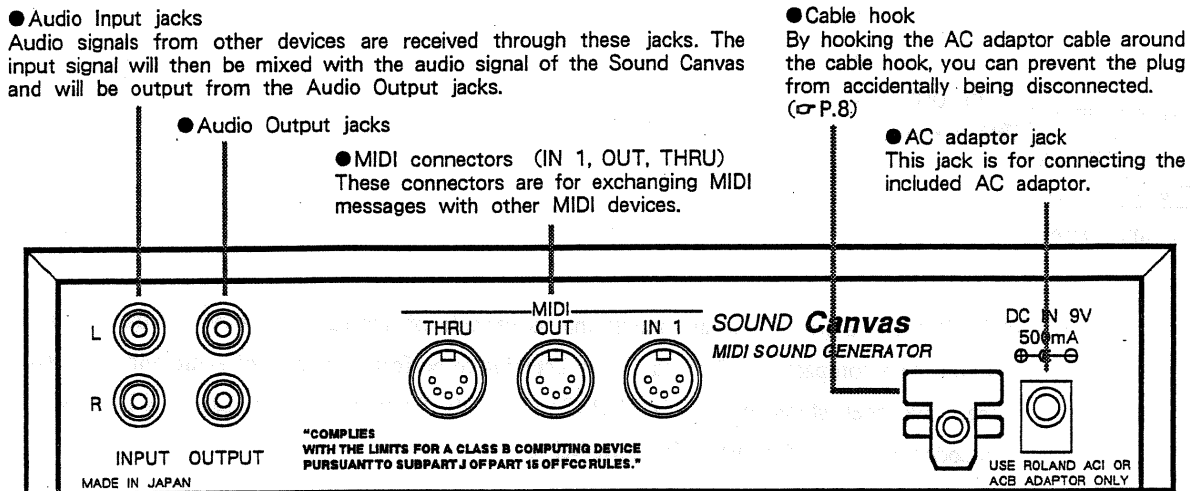

CONNECTIONS

● About the MIDI connectors

The Sound Canvas is equipped with 2 MIDI IN connectors. It makes no difference which connector you use when making MIDI IN connections. You can also connect two different MIDI devices. In this case, the MIDI messages received through both MIDI IN jacks will be mixed.

When using this unit with a MIDI keyboard

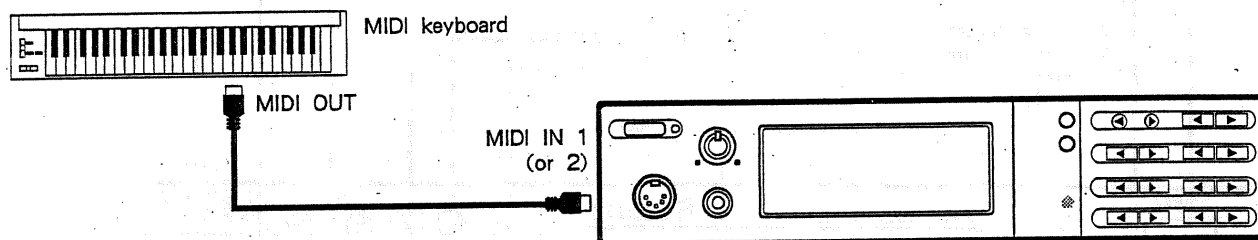

When using this unit with a sequencer, computer, or a CD-ROM MIDI decoder

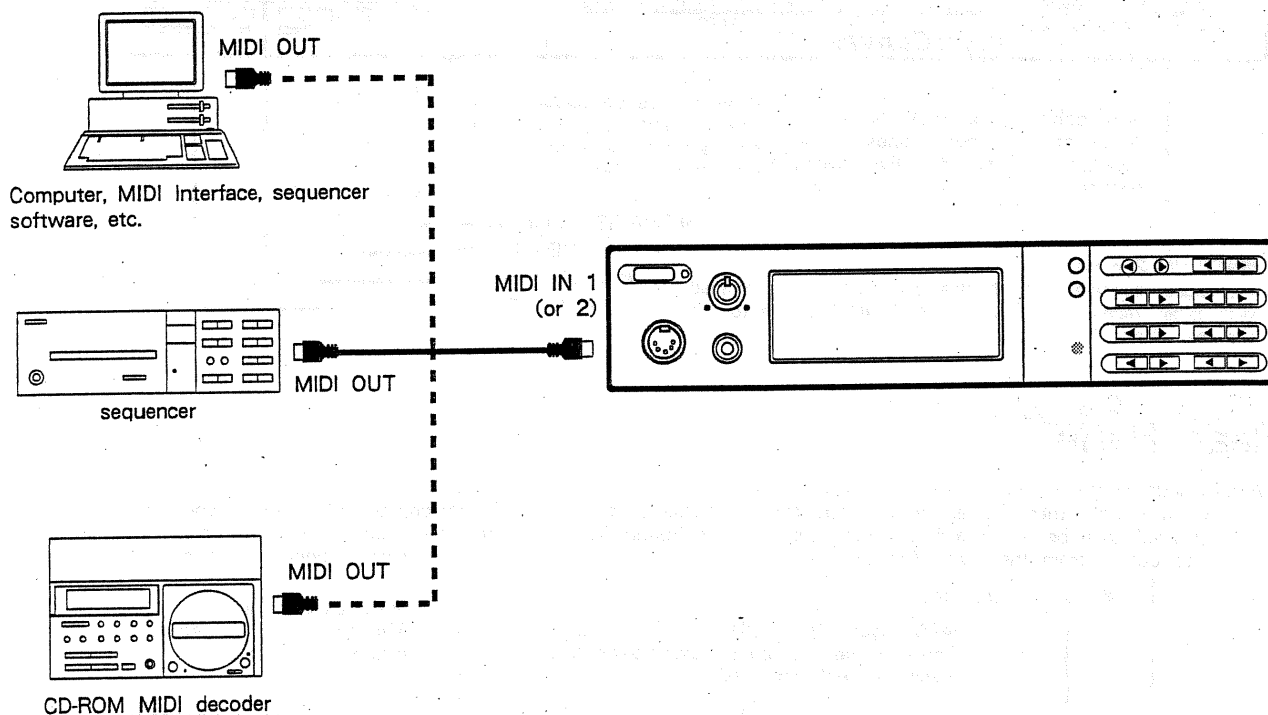

⇒ CD-ROM is a type of storage media that is capable of storing many bytes of data, on a disk, similar to a compact disc. You can enjoy listening to performance data of audio and MIDI signals that have been stored on CD-ROM (MIDIworld™) if you have a compatible CD-ROM MIDI decoder (Hyper Audio System™: CDR-M10).

* MIDIworld and Hyper Audio System are trademarks of Rittor Music and MIDIworld USA.

● Audio Output connections

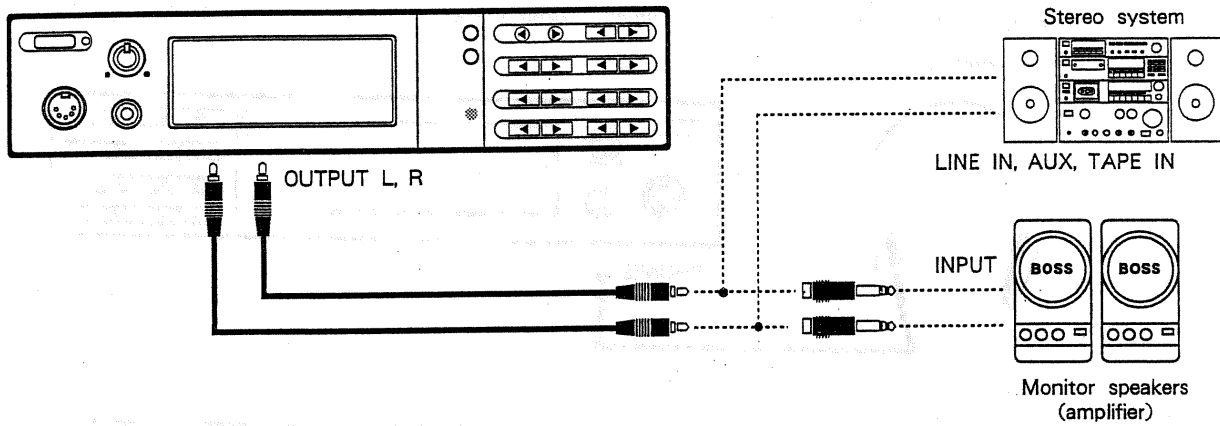

● Audio Input connections

The audio signals received through the Audio Input jacks will be mixed with the audio signals of the Sound Canvas and output from the Audio Output jacks. This function is convenient when using another MIDI sound module or a radio-cassette recorder.

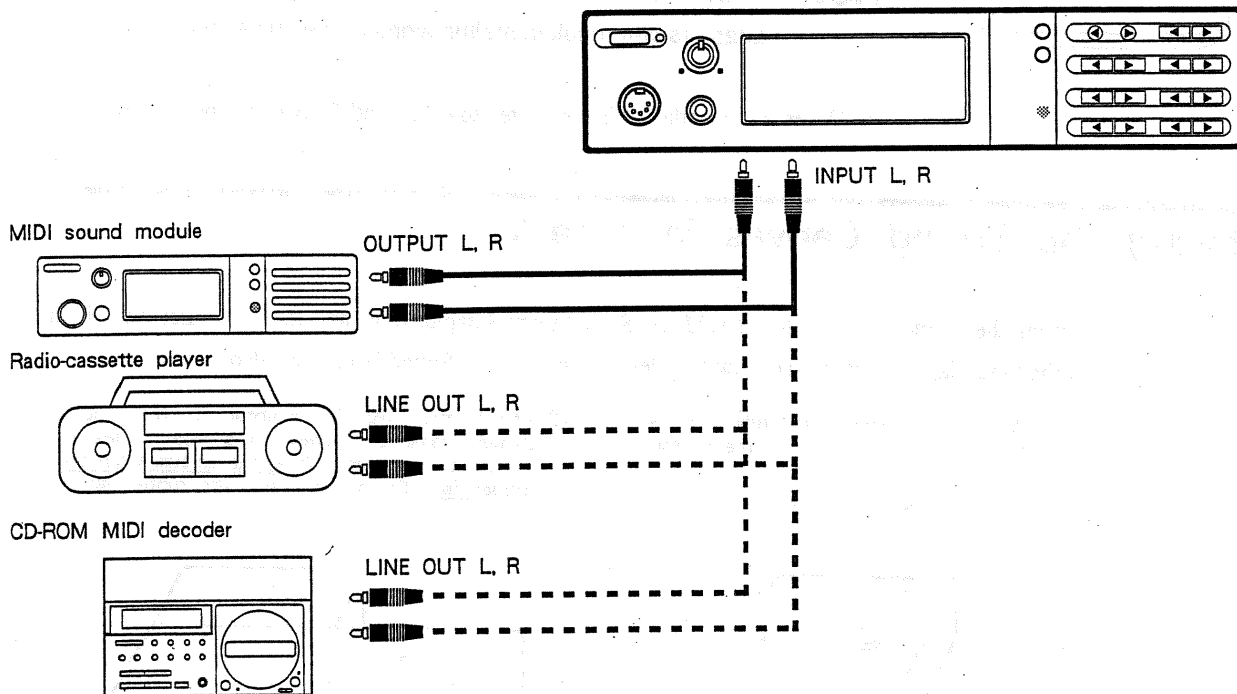

⇒ The included audio cable is equipped with a 1/4" (Phono) plug adaptor on one end and a standard RCA audio plug on the other end. If you remove the 1/4" (Phono) plug adaptor, both ends will have standard RCA audio plugs.



● Using headphones

Connect stereo headphones to the PHONES jack. For optimum performance, use headphones of an impedance from 8 to 150 ohms. Even when headphones are being used, sound will be output from the Output jacks.

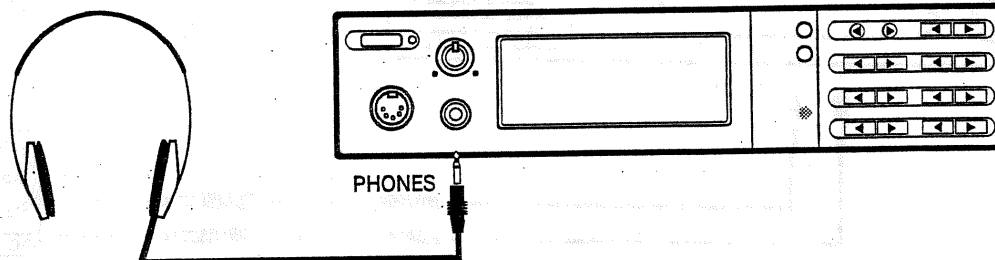

● Connecting the AC adaptor

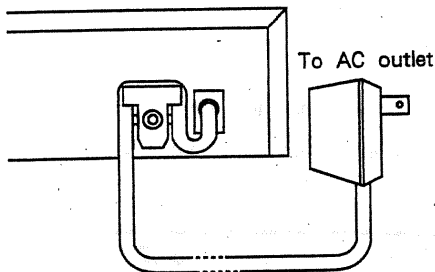

Connect the included AC adaptor to the Sound Canvas, and then plug it into an AC outlet. By looping the AC adaptor cable around the cable hook, you can prevent the plug from accidentally being disconnected.

Note: Please use only the included AC adaptor. Using other AC adaptors can result in malfunctions or electric shock.

⇒ When the AC adaptor is connected to the Sound Canvas, the power will be on.

● Installing the Sound Canvas in a rack

Install the Sound Canvas into the RAD-50 Rack Mount Adaptor (sold separately) as illustrated in the following diagram. Other half-rack size devices, such as the Sound Brush can also be installed.

① With a screwdriver, carefully remove the four rubber feet from the bottom of the unit.

② Attach the RAD-50 adaptor to the Sound Canvas using the screw holes located nearest the front of the unit, using the screws from the rubber feet. Do not re-attach the rubber feet.

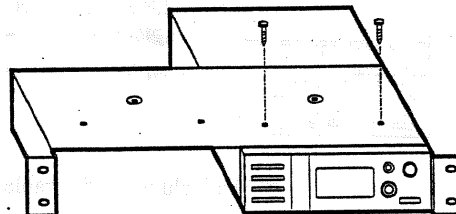
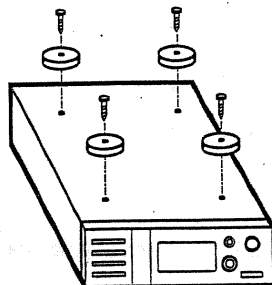

* When re-attaching the rubber feet to the unit, be sure to use the same screws that you used to attach the unit to the rack mount. Use of a different type of screw could result in damage or malfunction.

■ TURN THE POWER ON

- ① Before you turn the power on, check the following points:

Is the Sound Canvas correctly connected to the external devices?
Is the volume of the amplifier or sound system turned down?

- ② Turn the external devices and the Sound Canvas on.

The STANDBY indicator of the Sound Canvas will be off and the display will show the following:

PART	INSTRUMENT	
01	001	Piano 1
LEVEL	PAN	
70	0	
REVERB	CHORUS	
80	33	
K SHIFT	MIDI CH	
0	01	
		1 2 3 4 5 6 7 8 9 10 11 12 13 14 15 16
		PART

* The STANDBY indicator will be lit when the power is off. (when the AC adaptor is connected)

- ③ Turn on the power to your external audio equipment.

Adjust the volume of the amplifier or stereo system to the appropriate level.

Caution: High volume levels can damage speakers.

Ordinary audio speakers, as in a stereo system, are more sensitive than musical instrument amplification speakers. Take care when using ordinary audio speakers, sudden loud signals may damage them.

* Depending on the unit's location or the lighting conditions, the Sound Canvas's display may not always be clearly visible. If such is the case, adjust the LCD contrast. (☞ P.28).

< How to turn the power off >

- ① Before turning the power off, make sure that the volume of the amplifier is turned down.
- ② Turn the power of each device off in the following order.
Audio device → Sound Canvas and MIDI device

* Refer to P.34 for information about returning to the factory preset.

HOW TO USE THE REMOTE CONTROL

● Before using

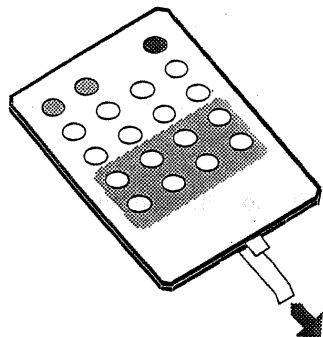

The remote control unit contains a lithium battery. An insulation sheet is inserted to keep the battery from discharging. You must remove this insulation sheet before using the remote control. Grasp the tab and pull the sheet out.

● How to use the remote control

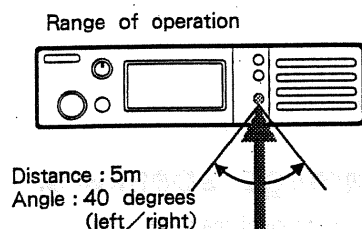

When using the remote control do not exceed the specified range of operation (5m). Always aim it towards the Remote Sensor on the front of the Sound Canvas. The remote control can also be used to control the SB-55 (Sound Brush MIDI sequencer, sold separately).

Each button on the remote control has the following function:

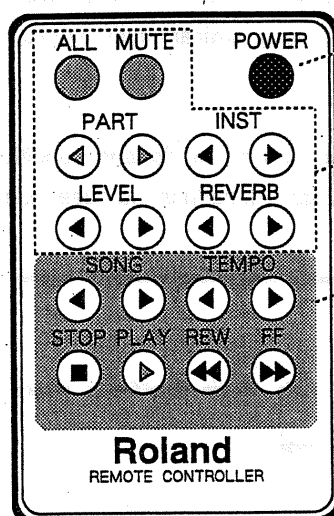
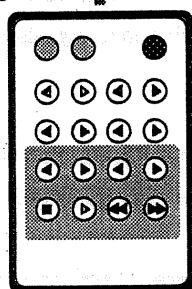

Power Button :
This button simultaneously controls the power for the Sound Canvas and the Sound Brush.

Sound Canvas Buttons :
These buttons duplicate the functions of the Sound Canvas's front panel buttons.

Sound Brush Buttons :
These buttons various functions of the Sound Brush.

Note: The remote control is able to transmit only one button operation at a time.

- * The remote control may not operate even within the range of operation if there is an obstacle between it and the main unit.
- * Using the remote control near other equipment that uses remote control systems may result in operational errors.
- * The life of the lithium battery depends on the amount and conditions of use. If after a while the operational range of the remote control decreases, change the lithium battery.
- * If you will not be using the remote control for a long period of time, remove the lithium battery.

< Using the Sound Canvas together with the Sound Brush Sequencer >

When you use the Sound Canvas together with the Sound Brush sequencer, the remote control of the Sound Canvas can turn the power to both units ON and OFF simultaneously. When you use the remote control with both units, be sure they are placed within the range of operation.

When you want to control only one of the units, turn off the remote control receiving switch of the unit that you do not want to control.

*When using the remote control to operate both units, be sure that both units are ON or OFF. If only one unit is ON when you begin, one units will always be ON while the other is OFF.

● When you don't want to use the Card Remote Control (Setting the remote control receiving switch)

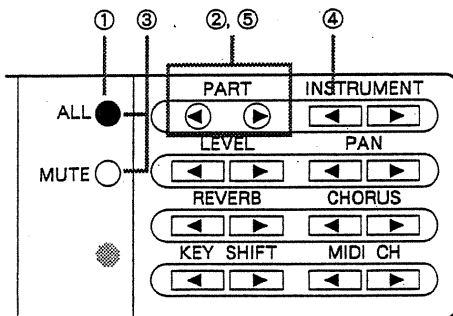

- ① Press **ALL** to turn the indicator light on.
If the button is already on, there is no need to press the button.
- ② Press the PART buttons (◀ and ▶) simultaneously.
- ③ Select "Rx Remote" with the **ALL** and **MUTE** buttons.
- ④ Press INSTRUMENT ◀ to turn the remote control receiving switch off.
Press INSTRUMENT ▶ to turn it back on.
- ⑤ After setting, press the PART buttons (◀ and ▶) simultaneously to finalize the setting.

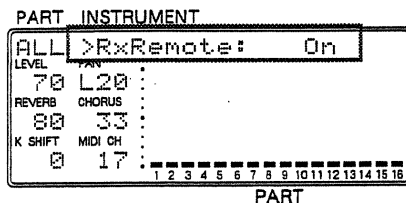

● How to change the lithium battery.

- ① Insert a fingernail into the groove on the back of the remote control and pull out the battery holder.
- ② Put the new lithium battery into the battery holder (positive "+" side up) and insert the battery holder back into the remote control.

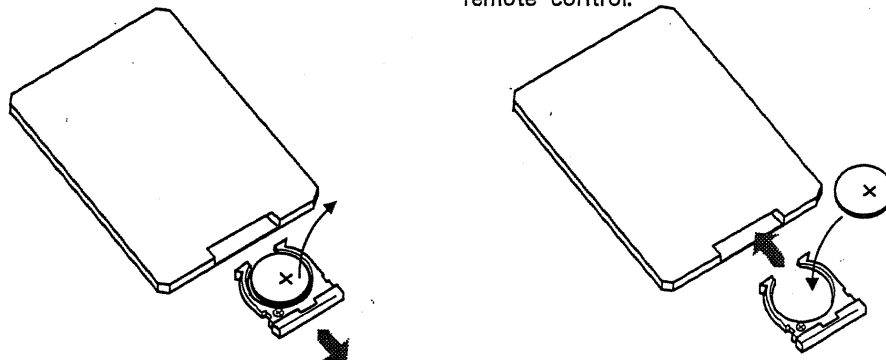

Note: Improper use of the lithium battery may cause leakage or explosion. Observe the following precautions:

- Use only the specified lithium battery (CR 2025).
- Ensure the polarity is correctly set (positive "+" side up).
- Do not short circuit the battery, attempt to dismantle it, or throw into a fire.

■ HOW TO LISTEN TO ROM PLAY

Demo songs that make the best use of the internal Multi-timbre sounds are stored within the Sound Canvas. Refer to the included information sheet for details about the Demo songs. The process of auto-playing these demo songs is called ROM play.

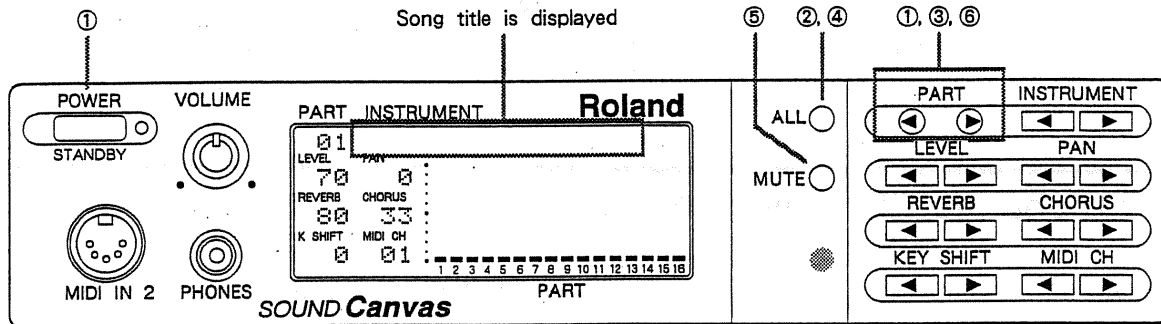

ROM
PLAY

Note: the Sound Canvas will be formatted to the GS Standard basic setting. Therefore, any parameters that have been edited will be lost.

- ① While holding PART ◀ and ▶, turn the power on.
When "Init GS, Sure?" will be shown in the display.
- ② Press [ALL] to execute (Press [MUTE] to stop the operation).
- ③ Select a song with the PART ◀▶ buttons.
- ④ Press [ALL] to start the song.
The volume level of each instrument will be shown on the bar graph display. All songs will be played in order beginning with the song you chose.
- ⑤ Press [MUTE] to stop playback.
- ⑥ Press [ALL] and [MUTE] simultaneously to return to normal playing status.

PLAYING THE VARIOUS INSTRUMENTS

The Sound Canvas contains various special effect sounds such as warble, and telephone, as well as many musical instrument sounds such as organ, piano, guitar, etc. Using these sounds, the Sound Canvas can reproduce to the performances of many types of music ranging from classical to rock to jazz. This manual refers to these sounds as "Instruments". If the Sound Canvas is connected to a MIDI keyboard, you can try out the sound of each instrument.

⇒ Refer to the Instrument Table (☞ P.66) for the various kinds of instruments.

⇒ The Sound Canvas also contains a drum set with various percussion instrument sounds. For more details, refer to "Drum set Table" (☞ P.70).

● How to change the instruments

Currently selected part number

Displayed instrument and name

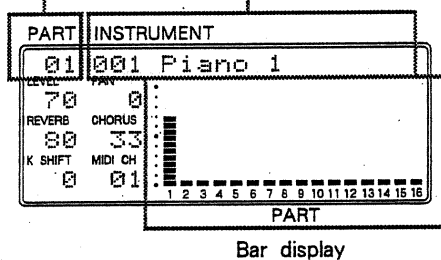

When you play your MIDI keyboard, the display will show the volume level of the instrument that is being heard.

① Before changing instruments, press **ALL** to turn the button indicator off.

② Play the sound, and by using the PART **◀ ▶** buttons, select the part number that corresponds to the number on the bar display showing a volume level.

③ Change instruments by using the INSTRUMENT **◀ ▶** buttons.

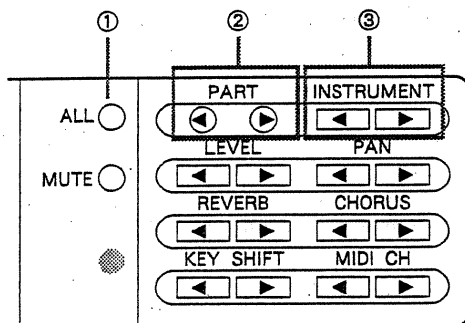

■ CHANGING THE VOLUME LEVEL/PAN

How to set the correct volume level and make the necessary pan settings.

● Changing the volume level of ALL (0—127)

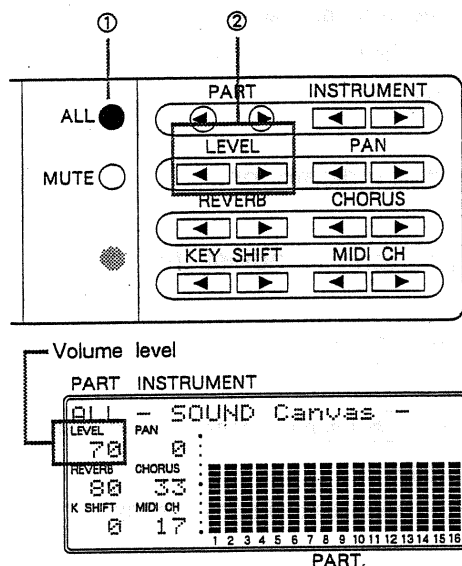

① Press **ALL** to turn the button indicator light on.

② Use the **LEVEL** buttons to adjust the volume level.

Higher values indicate higher volume levels.

⇒ When you press **LEVEL** and simultaneously, the current setting will be shown on the Bar display.

Press **LEVEL** and again to return to the previous display.

⇒ You can adjust the overall volume level by using the volume knob. However, if the volume knob is turned all the way down, no sound will be heard, regardless of the adjustments made using the above procedure.

● Changing the pan level of ALL (L63—0—R63)

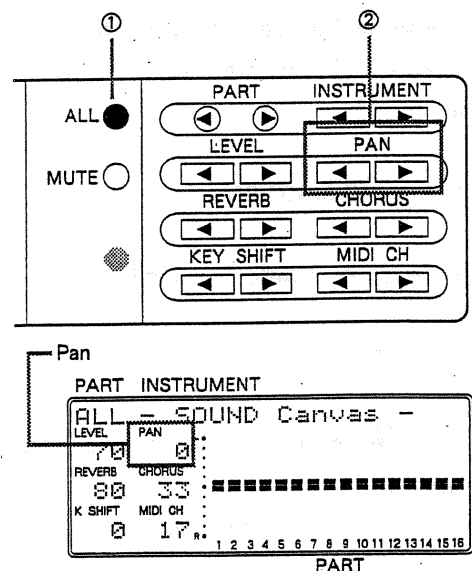

ALL pan adjusts the stereo location of all sounds.

① Press **ALL** to turn the button indicator on.

② Use the **PAN** buttons to adjust the pan level.

“0” indicates that sounds will be heard equally from the left and right speakers. Higher “L” values indicate that more sound will be heard from the left speaker. Higher “R” values indicate that more sound will be heard from the right speaker.

⇒ When you press **PAN** and simultaneously, the current setting will be shown on the Bar display.

Press **PAN** and again to return to the previous display.

* According to the instrument, even if you position pan to all the way left (or right) a small amount of sound might leak from the other speaker.

* When the Sound Canvas is connected to a monaural audio system, some effects cannot be properly attained.

HOW TO ADJUST REVERB/CHORUS

By adding Reverb and Chorus effects, instrument sounds will be enhanced. Use and adjust them according to your taste.

● How to adjust the Reverb level (0—127)

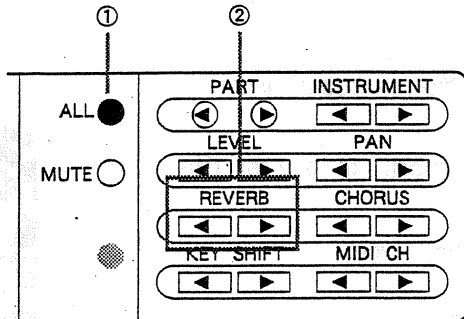

Reverb adds a spacious quality to the instrument sound. Listening to a sound containing Reverb is similar to listening in a concert hall. This adjustment determines how reverb is applied.

- 1 Press **ALL** to turn the button indicator on.
- 2 Use the REVERB **◀▶** buttons to adjust the reverb application.
Higher values indicate higher levels of Reverb.

⇒ When you press REVERB **◀** and **▶** simultaneously, the current setting will be shown on the Bar display.

Press REVERB **◀** and **▶** again to return to the previous display.

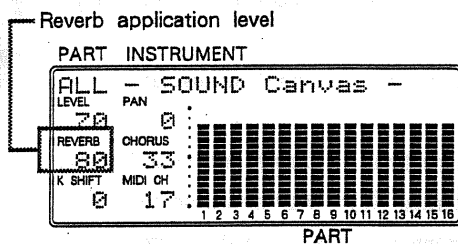

● How to adjust the Chorus level (0—127)

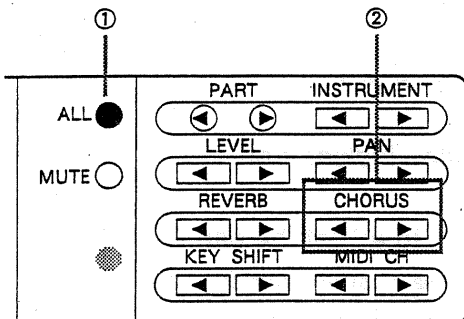

Chorus adds depth and warmth to the sound. This adjustment determines how Chorus is applied. Chorus is especially effective when used with instrument sounds such as organ, strings, etc.

- 1 Press **ALL** to turn the button indicator on.
- 2 Adjust the applied Chorus level by using the CHORUS **◀▶** buttons.
Higher values indicate higher levels of Chorus.

⇒ When you press CHORUS **◀** and **▶** simultaneously, the current setting will be shown on the Bar display.

Press CHORUS **◀** and **▶** again to return to the previous display.

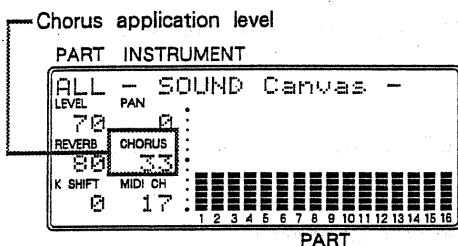

■ HOW TO TRANSPOSE ALL (KEY SHIFT)

Key shift is a function that changes the pitch of notes in semitone steps. For example: When using a sequencer to play the Sound Canvas, you can transpose to a different pitch without changing the settings of the sequencer.

* Changing pitch using the Key shift function will not affect the pitch of the drum set.

● How to Key shift (-24-0-+24 : in semitone steps, ± 2 octaves)

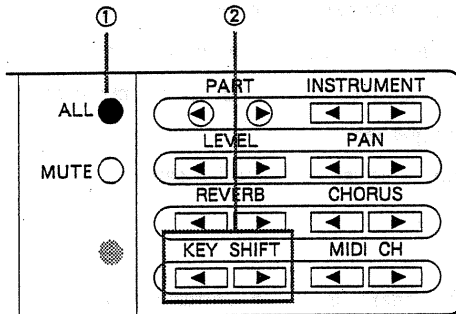

① Press **ALL** to turn the button indicator light on.

② Change Key shift values by using the KEY SHIFT **◀▶** buttons.

As the value goes up (down) by 1, the pitch goes up (down) by one semitone. As the value goes up (down) by 12, the pitch goes up (down) by one octave. A setting of "0" indicates standard pitch.

⇒ When you press KEY SHIFT **◀** and **▶** simultaneously, the current setting will be shown on the Bar display.

Press KEY SHIFT **◀** and **▶** again to return to the previous display.

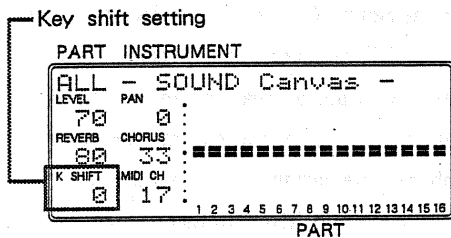

SELECTING INSTRUMENTS

How to select an instrument for each part.

● Part and Instrument

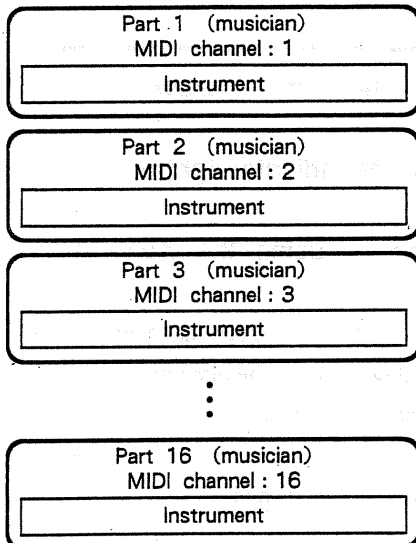

The following section briefly explains the relationship between Part and Instrument.

The Sound Canvas has 16 parts, and a different instrument can be assigned to each. You can think of a Part as being a musician playing an instrument, and in this way, the Sound Canvas can be thought of as 16 musicians playing many different instruments together.

A sound module such as the Sound Canvas is generally called a Multi-timbral sound module.

In an external MIDI device, MIDI channels 1—16 correspond to parts 1—16 of the Sound Canvas. When the Sound Canvas left the factory, it was preset so that part 1 corresponds to MIDI channel 1, part 2 corresponds to MIDI channel 2 and so on. When you want to hear the instrument of a particular part, set the MIDI transmit channel of the external device (i.e. MIDI keyboard) to match the number of the part that you want to hear.

Most MIDI keyboards have only one or two MIDI transmit channels so there is a limit to the number of parts you can use at once. To make the best use of the Sound Canvas's functions, combine it with a device that was designed to transmit many channels of MIDI data, such as a sequencer.

⇒For more details about MIDI refer to "About MIDI" (☞ P.58).

⇒When you want to change the MIDI channel of a part, refer to "Changing the MIDI receive channels" (☞ P.35).

< About the playable range of some instruments >

There are some notes that cannot be heard above or below a certain point depending on the particular instrument. This is because the instruments of the Sound Canvas are created based on the actual playable range of each acoustic instrument. Please consider the individuality of each instrument carefully before using it in a composition.

● How to change instruments

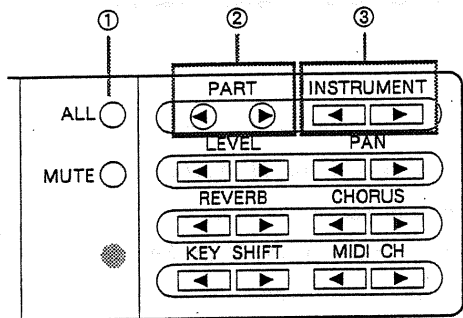

Currently selected part Instrument name and number of the displayed part

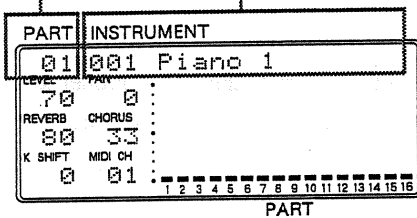

① Before changing instruments, press **ALL** to turn the button indicator off.

② Select the part number by using the PART **◀▶** buttons.

The name of the current instrument will be shown in the display.

③ Press INSTRUMENT **◀▶** to select an instrument.

⇒ Part number 10 is preset for the drum part and its various percussion sounds. For further details about the drum part, refer to the next page.

● How to change instruments using an external MIDI device

Part 1 (MIDI receive channel 1) will be changed to the instrument of program number 1.

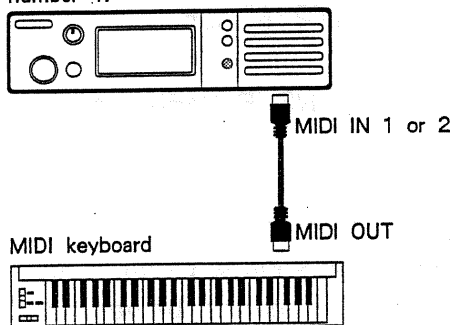

Transmitting program number 1 (MIDI transmit channel 1)

When you change instruments using a MIDI keyboard, the change information (program change message) will be transmitted from the MIDI OUT jack. When the message is received by the Sound Canvas, the instrument of the specified part (the same MIDI channel) will be changed.

The program number of the program change message determines which instrument will be selected. For example, if you select program number 1 on the MIDI keyboard, the Sound Canvas will also be changed to the instrument of program 1. Please check how the program numbers of the two MIDI devices correspond.

⇒ In the Sound Canvas, the instrument number corresponds to the program number.

⇒ Refer to the owners manual of your MIDI keyboard for information concerning its program numbers and sounds.

⇒ If you don't want to change instruments from the external MIDI device, turn the instrument receiving switch of the Sound Canvas off (P.46).

HOW TO SELECT THE DRUM SET

Try out the sounds of the various percussion instruments.

● Drum Set and drum part

The Sound Canvas contains a Drum Set with various percussion sounds. There are ten different combinations of percussion sounds to choose from. When you use the Drum Set, a part must be set for the drum part. Part 10 (MIDI receive channel 10) is the factory preset for the Drum Set. When you use part 10 for the Drum Set, set the MIDI transmit channel of the external MIDI device to 10. If you want the Drum Set to be heard without changing the MIDI transmit channel of the external MIDI device, set the same MIDI receive channel to the drum part.

⇒ When using a sequencer, adjust the note number setting of the sequencer beforehand to the percussion sound note number of the drum set that you are using.

● How to change the Drum Set

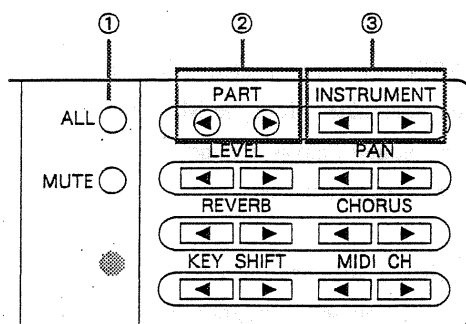

Currently selected Drum Set name and number

PART	INSTRUMENT
10	001*STANDARD
LEVEL	
70	0
REVERB	CHORUS
00	0
K SHIFT	MIDI CH
0	10
	1 2 3 4 5 6 7 8 9 10 11 12 13 14 15 16

- ① Press **ALL** to turn the button indicator light off.
- ② Select part 10 by using the PART **◀▶** buttons.
- ③ Select Drum Set by using the INSTRUMENT **◀▶** buttons.
- ④ If your MIDI keyboard is connected now, you can hear the various percussion instrument sounds by pressing the keys. (There are some keys that cannot be heard.)

⇒ Refer to the "Drum Set table" (P.70) for a list of each Drum Set's percussion instruments.

⇒ When you select the drum part, a "*" mark will appear before the Drum Set name. This will enable you to quickly check which part is set to the drum part.

● How to change the Drum Set using an external MIDI device

You can change the Drum Set, as well as the instrument (☞ P.59), with an external MIDI device. The Drum Set number corresponds to the program number.

⇒ If you don't want to change the Drum Set from the external device, turn the instrument receiving switch of the Sound Canvas off (☞ P.46).

● When you want to change the drum part number

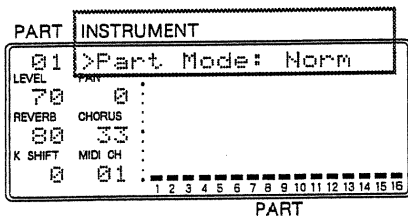
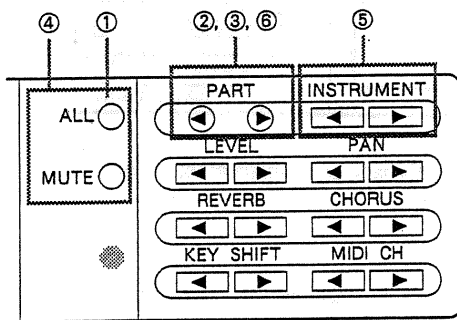

- ① Press **ALL** to turn the button indicator off.
- ② Select the part number that you want to assign the drum part to by using the PART **◀▶** buttons.
- ③ Press INSTRUMENT **◀▶** simultaneously.
- ④ Use **ALL** **MUTE** to select "Part Mode".
- ⑤ Press INSTRUMENT **◀** to select "Drum 1" or "Drum 2".
Select "Norm" to return to the regular part.
- ⑥ After setting, press PART **◀▶** simultaneously to finalize.

* Numerous parts can be set in the drum part however the two Drum Set types, "Drum 1" and "Drum 2" can be changed simultaneously. For instance for setting the drum parts as shown below, when you change the part 1 Drum Set, the part 3 Drum Set is also changed.

- Part 1 (Drum 1) : STANDARD
- Part 2 (Drum 2) : Jazz Set
- Part 3 (Drum 1) : STANDARD

PLAYING THE SOUND CANVAS USING A DRUM PAD

If you'd rather, you can play the Sound Canvas's drum sounds using a Roland PAD-5 (sold separately). The PAD-5 is an external MIDI device that has five drum pads that can be played by hand or with drum sticks. The PAD-5 also has a simple auto-play function that allows you to play a keyboard from the drum pads.

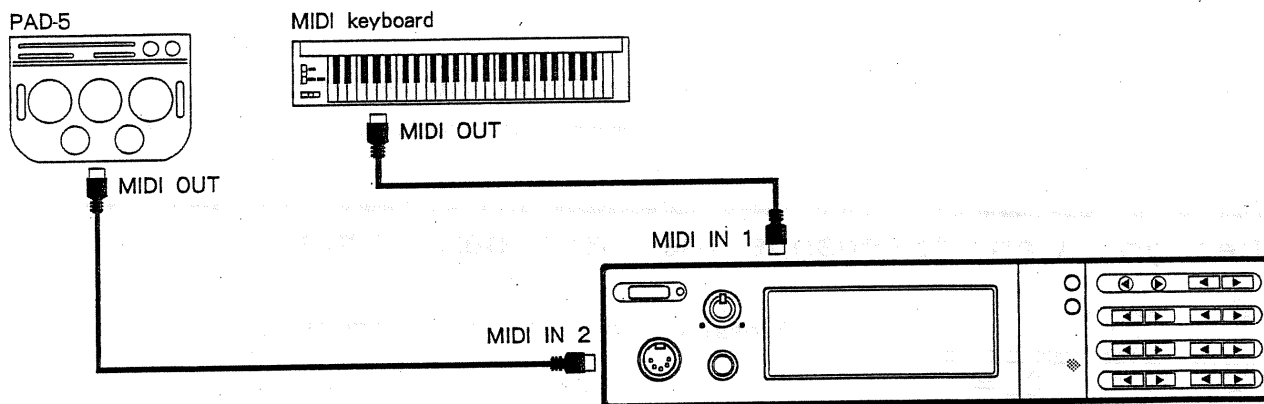

⇒ It makes no difference which MIDI IN jack each instrument is connected to.

⇒ The PAD-5's MIDI transmit channel is preset to 10. Likewise, part 10 (MIDI receive channel 10) of the Sound Canvas is preset to the drum part, so it isn't necessary to change the setting.

SETTING THE PART

You can set the volume level, pan, reverb, chorus and key shift for each part. You should make these settings with regard to the balance of each part.

□ The performance of each function

● LEVEL (volume level) : 0—127

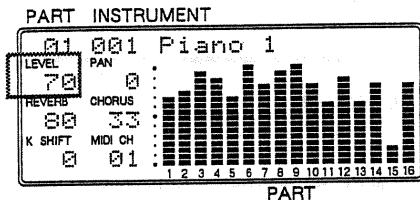

Adjusting the volume level of each part.

Use the LEVEL buttons to adjust the volume level. Higher values indicate higher volume levels.

● PAN : L63—0—R63, Rnd

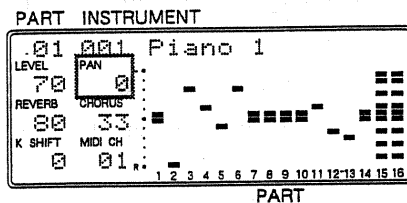

The pan setting of each part determines the stereo location of each instrument. One example of pan setting is shown in the illustration. The bass and Drum Set are in the center while the keyboard is on the left side and the guitar is on the right side.

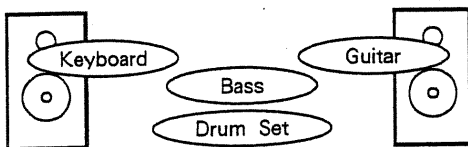

Use the PAN buttons to set pan levels.

“0” indicates a central stereo location. Higher “L” values indicate that more sound will be heard from the left speaker. Higher “R” values indicate that more sound will be heard from the right speaker. When “Rnd (random)” is selected, the sound will be moved to a different stereo location every time the instrument is heard. This random panning creates a unique effect.

⇒ The Drum Set has a preset stereo location for each percussion sound. If you change the pan level of the drum part, the stereo location of the entire Drum Set will be moved.

* According to the instrument, even if you position pan to all the way left (or right) a small amount of sound might leak from the other speaker.

* When the Sound Canvas is connected to a monaural audio system, some effects cannot be properly attained.

● REVERB : 0—127

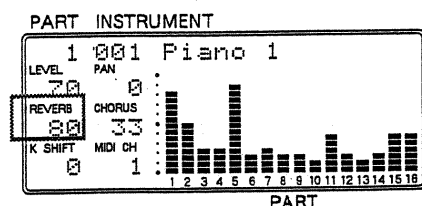

Use the REVERB buttons to adjust the reverb application.

Higher values indicate higher levels of reverb.

* If the reverb level (P.16) of all parts is small, the effect will not be greatly noticeable.

● CHORUS : 0—127

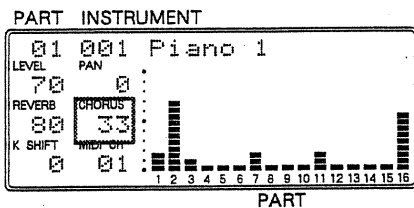

Use the CHORUS buttons to adjust the chorus application. Higher values indicate higher levels of chorus.

* If the chorus level () of all parts is small, the effect will not be greatly noticeable.

● KEY SHIFT : - 24—0—+ 24 in semitones steps, ± 2 octaves

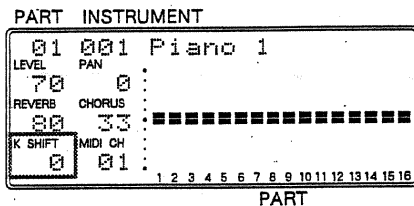

Set the key shift of a part when you want to transpose only a specified instrument.

Use the KEY SHIFT buttons to set the amount of key shift.

As the value goes up (down) by 1, the pitch goes up (down) by one semitone. As the value goes up (down) by 12, the pitch goes up (down) by one octave. A setting of "0" indicates standard pitch.

* Changing pitch using the Key shift function will not affect the pitch of the drum part.

□ How to set

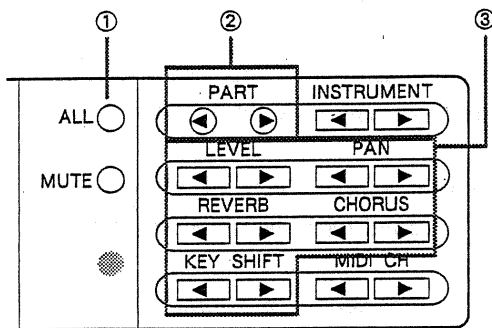

① Make sure that the **ALL** indicator is off. If the indicator is on, press the button to turn it off.

② Use the PART buttons to select the part that you want to transpose (key shift). Each setting of the current part will be shown on the display.

③ Use the following buttons to set each function:

LEVEL : Volume level

PAN : Pan

REVERB : Reverb

CHORUS : Chorus

KEY SHIFT : Key shift

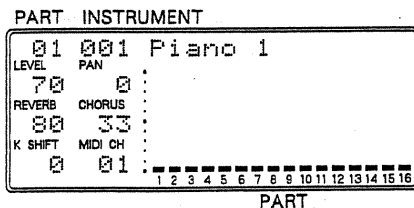

⇒ When you press and of a specified function simultaneously, the setting of each part will be shown on the bar display. Press and of the specified function simultaneously again to return to the previous display.

MUTE

Mute is a function that temporarily mutes the sound of a part. "ALL mute" temporarily mutes the sound of all parts and "PART mute" temporarily mutes the sound of a specified part. The Mute function is used when you don't want sound (ALL or PART) to be heard for a moment.

● Mute all parts (ALL mute)

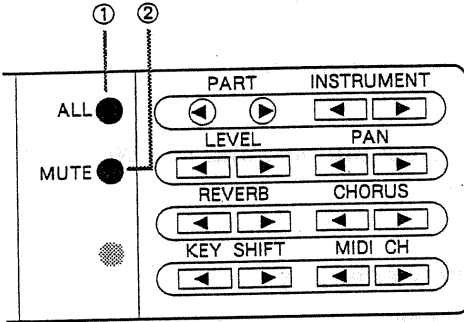

① Press **ALL** to turn the button indicator on.

② Press **MUTE** to execute the function.

When the Mute function is operating, the button indicator will be lit. Press the button again to return to the previous state.

● Mute a specified part (PART mute)

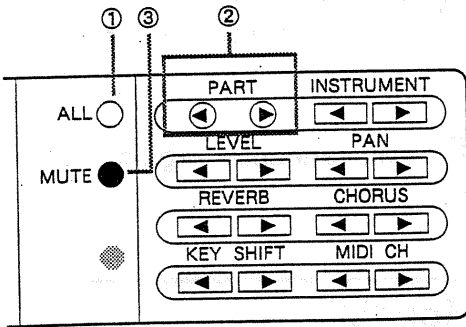

① Press **ALL** to turn the button indicator off.

② Use the PART **◀▶** buttons to select the part that you want to mute.

③ Press **MUTE** to execute the function.

When the Mute function is operating, the button indicator will be lit. Press the button again to return to the previous state.

PART	INSTRUMENT
01	001 Piano 1
LEVEL	PAN
70	0
REVERB	CHORUS
00	33
K SHIFT	MIDI CH
0	01

PART

⇒The **MUTE** indicator light will be lit only when the muted part is selected.

⇒The segment at the bottom of the bar display will be off, indicating a muted part.

MONITORING THE SOUND OF A PART

The monitor function has a Part Monitor that monitors the sound of one specified part, and All Monitor that monitors the sound of all parts regardless of the setting of Part Mute.

When you use ensemble performance with a sequencer, etc., Part Monitor is used to monitor the performance of one part. When some parts are muted by Part Mute, All Monitor is used to monitor the sound of all parts for a short while.

● Monitoring the sound of a part (Part Monitor)

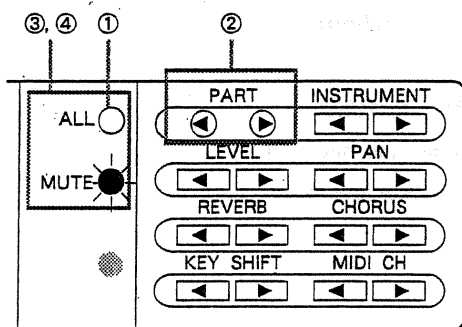

- ① Press **ALL** to turn the button indicator off.
- ② Use **PART** **◀** and **▶** to select the part that you want to monitor.
- ③ Press **ALL** and **MUTE** simultaneously. Mute indicator will blink. Only the current part can be monitored in this status.

⇒ If you change parts in the monitor status, the sound of the part that you selected can be monitored (even if you select the part that is muted by Part Mute).

- ④ Press **ALL** and **MUTE** simultaneously again to return to the previous status.

● Monitoring the sound of all parts (All Monitor)

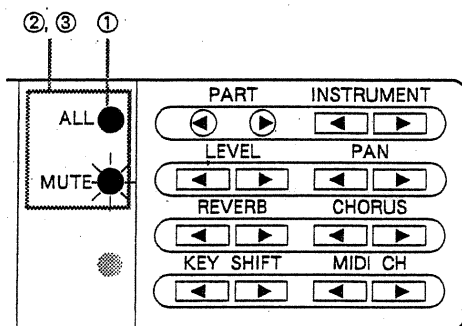

- ① Press **ALL** to turn the button indicator on.
- ② Press **ALL** and **MUTE** simultaneously. Mute indicator will blink. The sound of all parts can be monitored in this status regardless of the setting of Part Mute.
- ③ Press **ALL** and **MUTE** simultaneously again to return to the previous status.

TUNING TO THE PITCH OF ANOTHER INSTRUMENT

Adjust Master Tune when you want to play along with another instrument with a slightly different pitch, or when you want to adjust the Sound Canvas's pitch to match that of another instrument.

● Master Tune : 415.3—466.2Hz

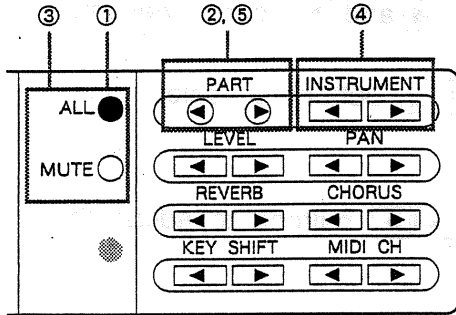

- ① Press **ALL** to turn the button indicator on.
- ② Press the **PART** buttons (**◀** and **▶**) simultaneously.
- ③ Use the **ALL** and **MUTE** buttons to select "M.Tune".
- ④ Use the **INSTRUMENT** **◀▶** buttons to adjust the pitch.

The displayed value (440.0) is the frequency of A4 on a keyboard.

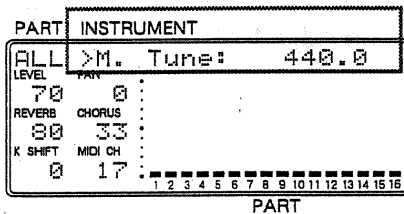

- ⑤ After tuning, press the **PART** buttons (**◀** and **▶**) simultaneously to finalize the setting.

■ ADJUSTING THE CONTRAST OF THE DISPLAY

In some cases, depending on placement or lighting conditions, the display screen may not be seen clearly. In such a case adjust the contrast of the display screen.

● LCD Contrast : 1—16

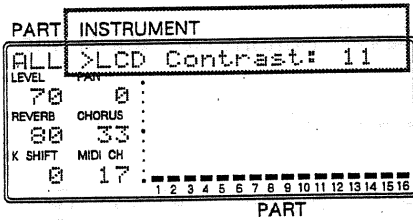
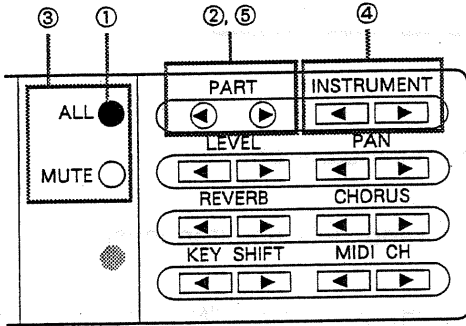

- ① Press **ALL** to turn the button indicator on.
- ② Press the PART buttons (**◀** and **▶**) simultaneously.
- ③ Use the **ALL** and **MUTE** buttons to select "LCD Contrast".
- ④ Use the INSTRUMENT **◀▶** buttons to adjust the contrast.
- ⑤ After adjusting, press the PART buttons (**◀** and **▶**) simultaneously to finalize the adjustment.

HOW TO SET THE BAR DISPLAY

(Bar display/Peak hold)

< Bar display >

You can select which type of display will be used to indicate the volume level. There are eight display types to choose from:

Type 1: Bar display (normal)

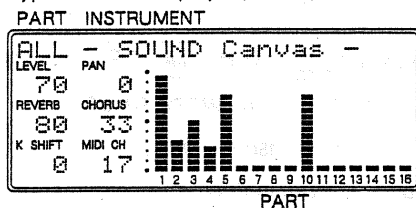

Type 5: Reverse 1

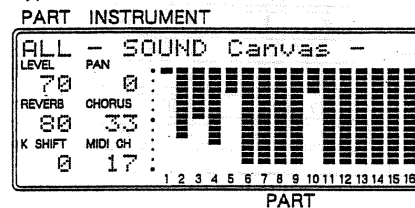

Type 2: Single segment display

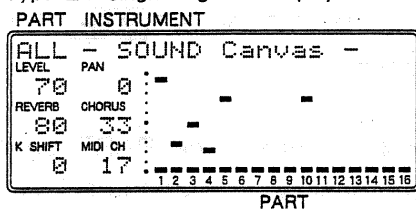

Type 6: Reverse 2

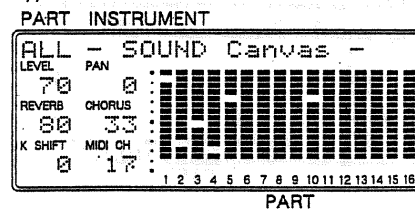

Type 3: Top to bottom Bar display

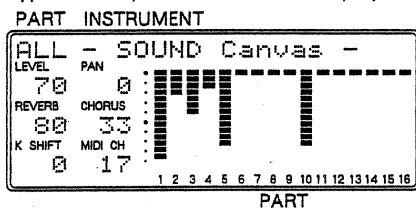

Type 7: Reverse 3

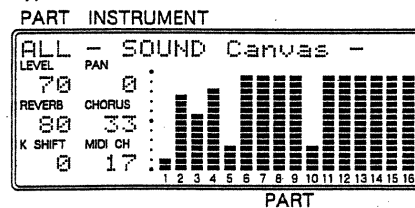

Type 4: Top to bottom Single segment display

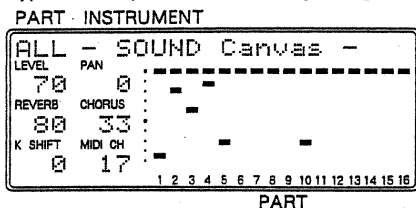

Type 8: Reverse 4

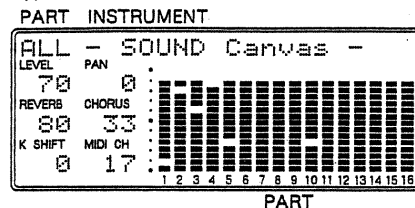

< Peak hold >

The Bar display holds the peak level segment for a few moments even if the volume level goes down. This will allow you to easily check the peak level (maximum value). You can select one of the four following types of peak level display:

Off : Peak level hold is not in effect.

Type 1 : The peak level segment goes down after holding the peak level (normal)

Type 2 : The peak level segment goes off after holding the peak level

Type 3 : The peak level segment goes up after holding the peak level

*When Type 1 or Type 3 is selected for Bar Display types 3, 4, 7, and 8, the Peak Level dot will be inverted.

● Setting instructions

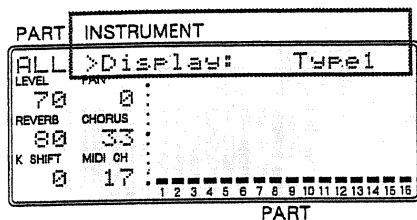
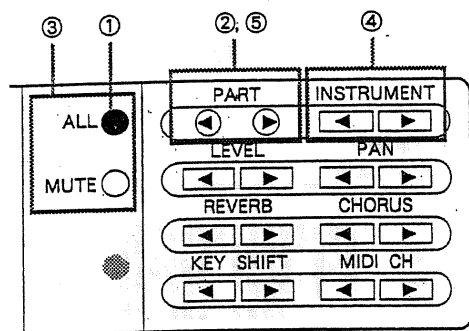

- ① Press **ALL** to turn the button indicator on.
- ② Press the PART button (**◀** and **▶**) simultaneously.
- ③ Use the **ALL** and **MUTE** buttons to select the display function you want to set.
 - "Display" : Bar display type
 - "Peak Hold" : Peak hold type
- ④ Use the INSTRUMENT **◀▶** buttons to set the display types.
- ⑤ After setting, press the PART button (**◀** and **▶**) simultaneously to finalize the selection.

■ SETTING THE SOUND CANVAS TO THE SOUND ARRANGEMENT OF THE MT-32

The Sound Canvas can be set to the sound arrangement of the MT-32 (Multi-Timbral Sound Module) which is a standard sound producing device for computer music applications. If you want to hear song data that was created for the MT-32, set the Sound Canvas according to the instructions below.

● Initial settings

When you set the Sound Canvas to the sound arrangement of the MT-32, The Sound Canvas settings will become identical to the power on settings of the MT-32. The following illustration shows these settings.

< Part settings >

Part	MIDI Receive channel	Instrument (Instrument number)	Volume level	Pan	Reverb	Chorus	Key Shift
1	1	Acou Piano 1 (1)	100	0	64	0	0
2	2	Slap Bass 1 (69)	100	L10	64	0	0
3	3	Str Sect 1 (49)	100	L10	64	0	0
4	4	Brs Sect 1 (96)	100	L10	64	0	0
5	5	Sax 1 (79)	100	L10	64	0	0
6	6	Ice Rain (42)	100	L46	64	0	0
7	7	Elec Piano 1 (4)	100	R27	64	0	0
8	8	Bottle Blow (111)	100	L63	64	0	0
9	9	Orche Hit (123)	100	R63	64	0	0
10 (Drum)	10	CM-64/32L Set (128)	100	0	64	0	0

* Parts 11 — 16 are factory presets.

< Setting of all parts >

Volume level	Pan	Reverb	Chorus	Key Shift
127	0	64	64	0

● Differences of the MT-32

If you set the Sound Canvas to the sound arrangement of the MT-32, you will be able to play in the same manner as if you were playing the MT-32, however, since the sound module of the MT-32 is organized differently from the Sound Canvas, you will not be able to perfectly duplicate the operations of the MT-32. Please consider the following differences:

< Changing the sound >

When you change the sound of an instrument using velocity, modulation, aftertouch, etc., delicate changes in the sound will appear differently than those of the MT-32.

< Exclusive messages >

The Sound Canvas and the MT-32 cannot exchange exclusive messages. Therefore if exclusive messages of the MT-32 are received by the Sound Canvas, the settings of the latter will not be changed. For example, if the sound data of the MT-32 (exclusive message) is stored to song data, the same data cannot be perfectly reproduced when using the Sound Canvas.

< Pan >

Pan movement is opposite from an actual MT-32. To rectify this, connect the L/R of the Audio Output jacks conversely.

< Maximum simultaneous notes >

The MT-32 has a higher number of maximum simultaneous notes (MT-32: 32 tones, Sound Canvas: 24 tones) but the Sound Canvas uses a lower number of partials to create instrument sounds. So in actuality, the Sound Canvas makes better use of note number.

Note: When you set the Sound Canvas to the sound arrangement of the MT-32, all prior settings will be lost.

⇒ The maximum number of simultaneous notes will differ depending on the number of partials being used. For more details, refer to P.40.

⇒ When you want to return to the previous sound arrangement after setting the Sound Canvas to the MT-32 arrangement, refer to "Returning to Factory Preset" on the page 34.

● Setting the sound arrangement of the MT-32

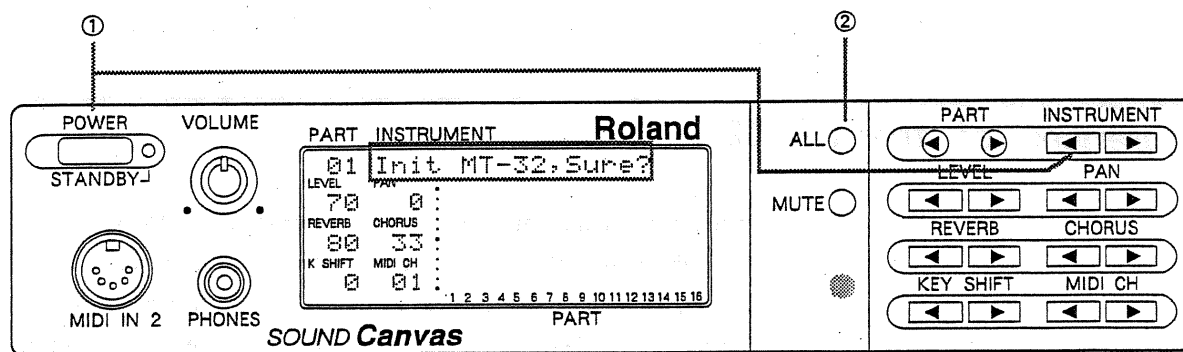

① INSTRUMENT , turn the power on.
"Init MT-32, Sure?" will be shown in the display.

② Press **ALL** to execute. (Press **MUTE** to stop the operation)

■ MAKING THE BASIC GS STANDARD FORMAT

When you want to play song data that is conformed to GS Standard, format the unit to the basic setting of GS standard. When you format to the basic setting of GS standard, all settings of the Sound Canvas will be returned to the factory preset except the system functions (☞ P.63).

● Making the basic GS Standard format

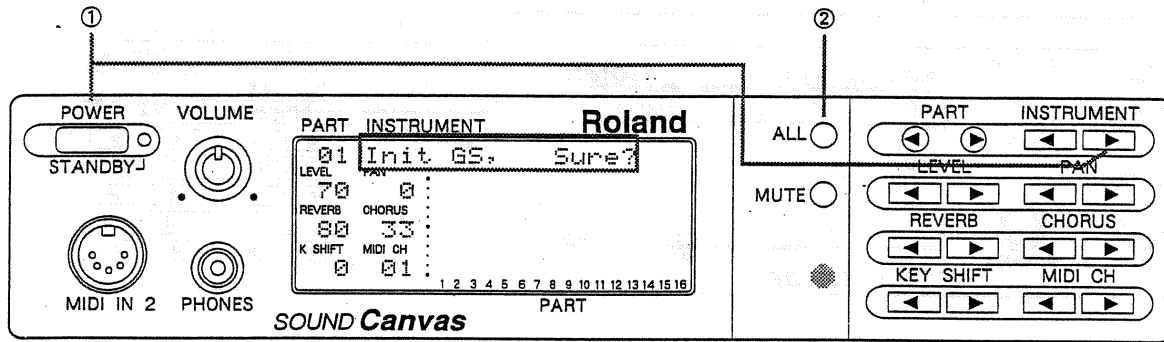

① While holding INSTRUMENT , turn the power on. "Init GS, Sure?" will be shown in the display.

② Press **ALL** to execute. (Press **MUTE** to stop the operation)



Note: Setting the unit to the basic GS Standard format.
The above procedure will set the Sound Canvas to the GS Standard format even if the backup switch (☞ P.34) is on.

< GS Reset Switch On/Off >

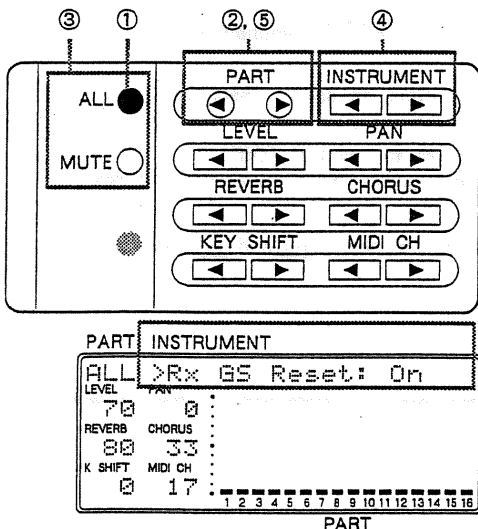

If the Sound Canvas receives an All Reset message, it will return to the basic setting of GS Standard format. (An "all reset" message is stored to the demo song of the separately sold Sound Brush sequencer.) If you don't want the Sound Canvas making the GS standard setting when receiving an all reset message, turn the GS Reset switch off (when the factory settings are on.).





① Press **ALL** to turn the button indicator light on.

② Press the PART buttons ( and ) simultaneously.

③ Use the **ALL** and **MUTE** buttons to select "Rx GS Reset".

④ Press INSTRUMENT  to turn the switch "Off".
When you want to turn the switch "On", press INSTRUMENT .

⑤ After setting, press the PART buttons ( and ) simultaneously to finalize.

RETURNING TO FACTORY PRESET

Use the following procedure for things like returning the Sound Canvas to the factory preset after changing the settings of various functions, or for returning to the original sound arrangement of the MT-32 after having changed it.

● Returning to factory preset

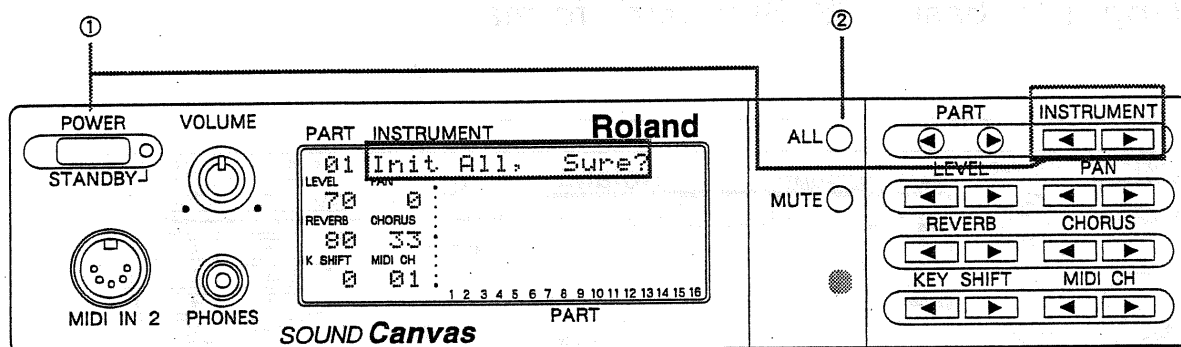

- ① Set the power to ON while pushing INSTRUMENT and .
- "Init All, Sure?" will be displayed.
- ② Press **ALL**. (Press **MUTE** to stop the operation.)

< Backup Switch On/Off >

There is a backup switch contained in the Sound Canvas for storing previous settings even after the power is turned off. Usually, this switch is set to on, but when you want to turn the power back on or if you want to reset the Sound Canvas to the basic setting of GS Standard, turn the backup switch off using the following procedure.

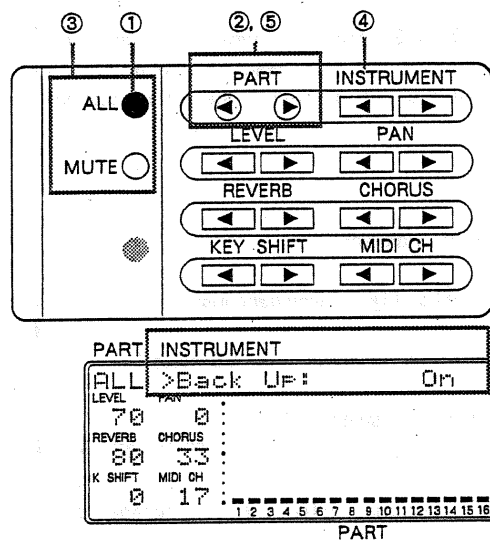

* The System function setting will be stored regardless of the on/off setting of the Backup switch.

- ① Press **ALL** to turn the button indicator light on.
- ② Press the PART buttons (and) simultaneously.
- ③ Use the **ALL** and **MUTE** buttons to select "Back Up".
- ④ Press INSTRUMENT to turn the switch "Off".
When you want to turn the switch "On", press INSTRUMENT .
- ⑤ After settings, Press the PART buttons (and) simultaneously to finalize.

■ CHANGING THE MIDI RECEIVE CHANNEL (PART)

Use the following procedure to change the MIDI receive channel of each part.

● Changing the MIDI receive channel (Part) : 1—16, Off

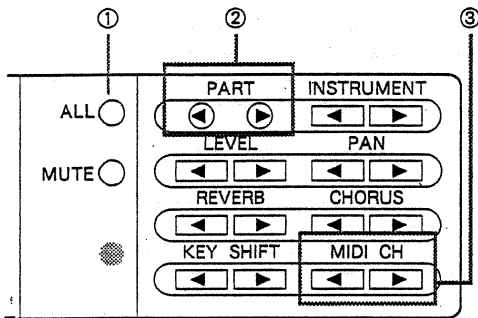

① Press **ALL** to turn the button indicator off.

② Use the **PART** buttons to select the part.

The MIDI receive channel of the selected part will be shown in the display.

③ Use the **MIDI CH** buttons to change the MIDI receive channel.

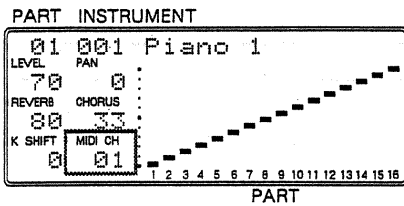

⇒ If you press **MIDI CH** buttons simultaneously, the MIDI receive channel setting of each part will be shown on the Bar Display. Press **MIDI CH** buttons again to return to the previous display.

CHANGING THE TYPE OF REVERB AND CHORUS

You can select one of eight types of both Reverb and Chorus effects. Make these selections according to your preference. The effect that is chosen will be applied to all parts, therefore when changing the type, please consider how the effect will affect each part. (☞ P.23)

< Reverb type >

Type	Effect
Room 1—3	Reverb that simulates the natural echo of a room. Sharply-defined reverb with a broad spread.
Hall 1—2	Reverb that simulates the natural echo of a hall. Smooth reverb, with greater depth than room.
Plate	This effect simulates Plate Echo (a type of reverb that uses the vibration of metal plates to produce a metallic echo).
Delay	Standard delay effect.
Panning Delay	Delay repetitions pan to left and right. This effect can be used if the unit is connected to a stereo audio device. It is effective when the Sound Canvas is connected to a stereo system.

< Chorus type >

Type	Effect
Chorus 1—4	Standard chorus effect.
Feedback Chorus	Chorus effect that simulates a flanger with soft sound.
Flanger	An effect that is sometimes used to simulate the takeoff and landing of a jet.
Short Delay	A delay repeated in a short time.
Short Delay (FB)	A short delay repeated many times.

● How to change the Reverb and Chorus type

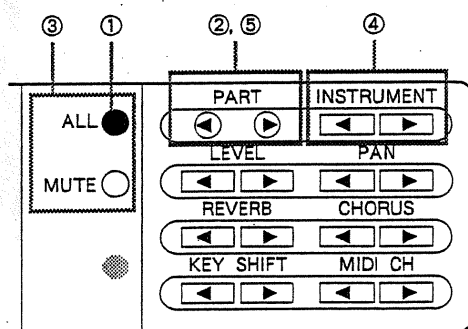

- Press **ALL** to turn the button indicator light on.
- Press the PART buttons (◀ and ▶) simultaneously.
- Use **ALL MUTE** to select the function that you want to set.
Reverb
Chorus
- Use the INSTRUMENT (◀ ▶) buttons to select the type.
- After setting, press the PART buttons (◀ and ▶) simultaneously.

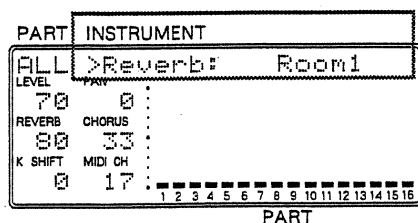

■ CHANGING THE WAY THE SOUND IS OUTPUT

Bend Range, Modulation Depth, Key Range, Velocity sens Depth, Velocity sens Offset, and M/P mode functions can be set according to your own taste. These functions affect the way the sound of each part is output.

□ The operation of each function

● Bend Range : 0—+24 (semitone steps, +2 octaves)

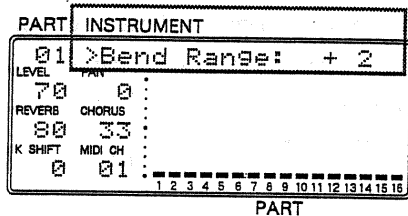

Bend Range determines the range over which the pitch can change by using the pitch bend lever or wheel (pitch bend message) on a MIDI keyboard.

⇒ The pitch bend lever (wheel) is often used to create vibrato effects and to emulate the sound of a violin or the bending of strings on an electric guitar.

● Modulation Depth : 0—127

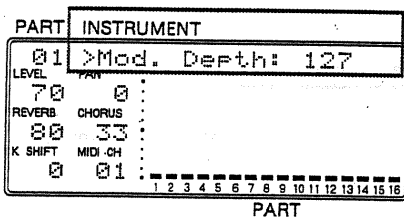

The Modulation Depth value determines the depth of the modulation (vibrato effect etc.) which is applied using the modulation lever or wheel (modulation message).

● Key Range : C-1—G-9

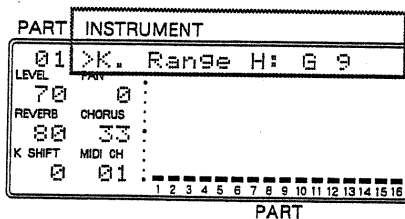
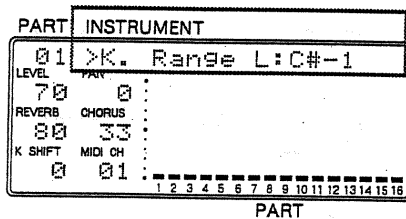

Key Range is a function that determines the range over which a particular sound will be heard. This range is determined by the settings of Key Range L (the lowest note) and Key Range H (the highest note). The value is displayed using the name of the note that shows the position of the key. Middle C is C4. You can set this function within the range of C1—G9.

Set Key Range when you are using a MIDI keyboard to play the Sound Canvas.

For example: Set parts 1 and 2 to the same MIDI receive channel. Then set the Key Range of part 1 to C-1—B3, and the Key Range of part 2 to C4—G9. Then, by assigning a different instrument to parts 1 and 2, you can play two different instruments on one MIDI keyboard with C-4 as the dividing point.

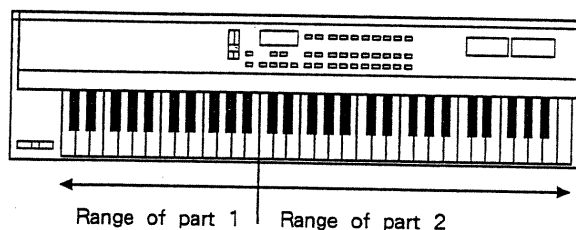

- Velocity Sens Depth : 0—127
- Velocity Sens Offset : 0—127

Changing the velocity value of the note message that is received by the Sound Canvas will determine how the volume will be changed.

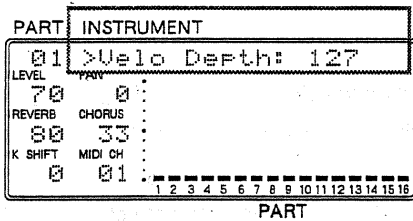

< Depth >

Higher Velocity Sens Depth values result in larger inclination of volume change. When you set the value to "0", the volume will not change regardless of how strongly you play the keyboard.

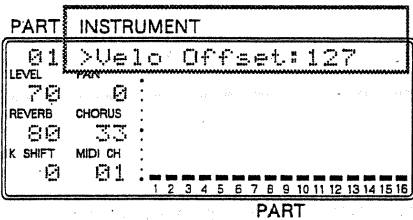
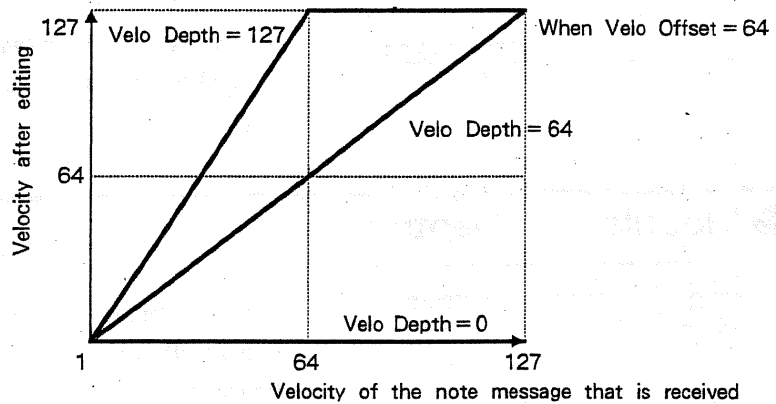

< Offset >

Velocity Sens Offset determines at what point volume will be changed according to keyboard dynamics. If the value is set to 64 or higher, the volume can be changed by playing the keyboard softly. If the value is set below 64, the volume can be changed by playing the keyboard more strongly.

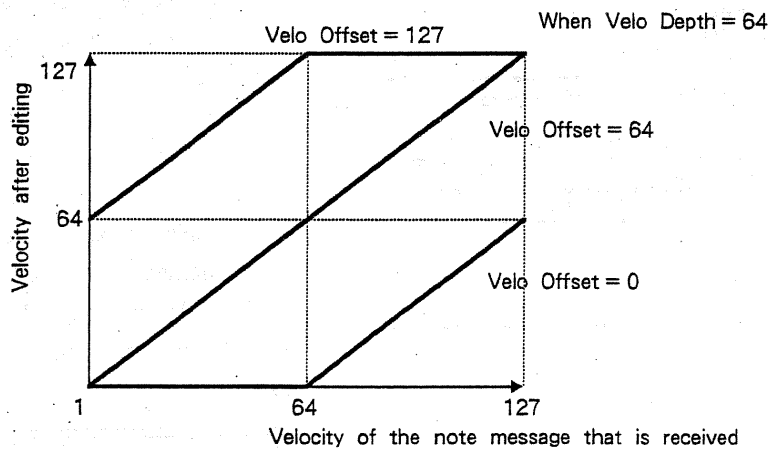

● **M/P mode** : Poly, mono

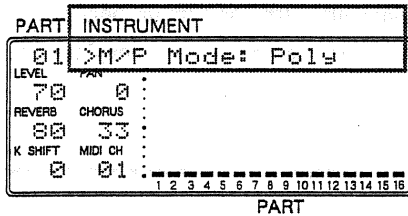

Select the mode of sound output.

Poly : Many notes can be played or heard at once. This is the usual setting.

Mono: Only one note can be played or heard at once. Use this setting for solo instruments such as brass, trumpet.

* Modifying the setting of M/P mode will not affect the sound that is set to the drum part.

□ **Setting instructions**

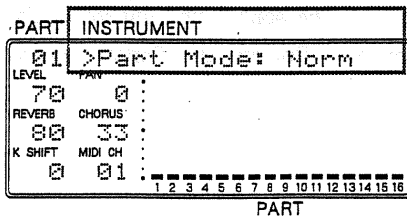
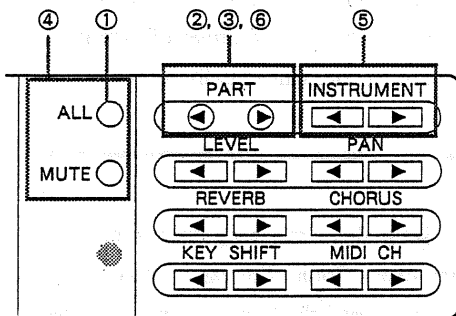

① Make sure that the **ALL** button indicator is off. If the indicator is on, press the button to turn it off.

② Press the PART buttons (◀ and ▶) simultaneously.

③ Use the PART ◀▶ buttons to select the part.

④ Use the **ALL** and **MUTE** buttons to select the function that you want to set.

Bend Range

Modulation Depth

Key Range L

Key Range H

Velocity Depth

Velocity Offset

M/P Mode

⑤ Use the INSTRUMENT ◀▶ buttons to set the values.

⑥ After setting, press the PART buttons (◀ and ▶) simultaneously to finalize the settings.

■ HOW TO USE PARTS FOR ENSEMBLE PERFORMANCE (Partial reserve)

The Sound Canvas has a limited number of notes that can be played or heard simultaneously (the Maximum polyphony). When using a sequencer for ensemble performance (using many instruments at once) the maximum polyphony may be exceeded. The following section will explain how to resolve this problem.

● About the maximum polyphony

The Sound Canvas can play up to 24 notes simultaneously. The number of notes that will actually be heard depends upon the instrument that is selected.

Some instruments are created by combining two types of partials (parts of a sound) to get a more realistic sound. When you want to hear or play an instrument such as this, you must use two partials. Therefore, the maximum polyphony will be 12. When using many instruments at once (ensemble playing) to create song data, you should consider the number of partials in each part and the maximum number of notes that will actually be heard.

● When exceeding the maximum polyphony

When using a sequencer to create song data, the song data should be written with the maximum polyphony of the Sound Canvas in mind. If the song data should happen to temporarily exceed the limit, it is possible that some important notes will be cut, making the song sound unnatural. The Sound Canvas provides a Note Sounding Priority and Partial Reserve function to minimize such occurrences.

Note Sounding Priority order of part

Note Sounding Priority order	Part number
1	10 (Drum part)
2	1
3	2
4	3
5	4
6	5
7	6
8	7
9	8
10	9
11	11
12	12
13	13
14	14
15	15
16	16

When the number of notes exceeds 24 partials, that have been sounding the longest notes will be turned off in order. The Note Sounding Priority order determines the priority with which to turn off the notes. In short, the part having the lowest priority will be turned off first, the next to lowest will be turned off second, and so on.

The part's Note Sounding Priority order is shown in the chart on the left. When you make a song, consider the priority order carefully when you specify each Sound Canvas part.

< Partial Reserve >

The part's Note Sounding Priority only determines the priority order. It does not secure the number of notes that will be heard. Therefore, it is possible that a part will be cut off even if it has a high priority. Partial Reserve is an effective function for resolving this problem.

Partial Reserve is a function that reserves a minimum number of partials for each part, in case the total number of partials exceeds 24. For example, if you set the Partial Reserve of a particular part to 10, ten notes will be reserved for that part regardless of Note Sounding Priority order. If the instrument consists of one partial, ten notes will be secured for that instrument. Furthermore, the Sound Canvas can play up to 24 notes (partials) simultaneously, so the total number of partials that can be secured is 24.

● Partial Reserve : 1—24

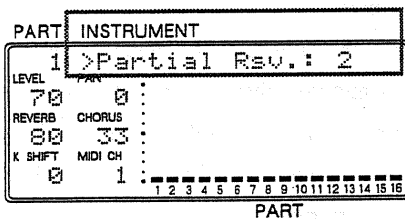
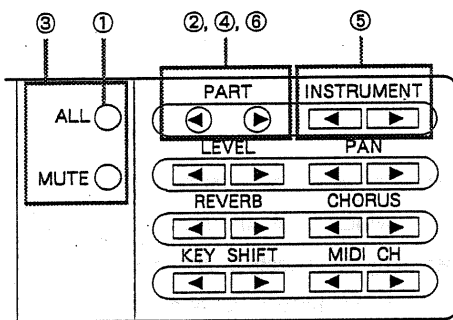

- ① Make sure that the **ALL** button indicator is off. If the indicator is on, press the button to turn it off.
- ② Press the PART buttons (◀ and ▶) simultaneously.
- ③ Use the **ALL** and **MUTE** buttons to select "Partial Rsv".
- ④ Use the PART ◀▶ buttons to select the part.
- ⑤ Use the INSTRUMENT ◀▶ buttons to set the partial number.
- ⑥ After setting, press the PART buttons (◀ and ▶) simultaneously to finalize the setting.

* The total number of partials that you can reserve for all parts is 24. If the number doesn't get any higher at the time of setting, make the partial.reserve number of the other parts lower.

SELECTING INSTRUMENT VARIATION

Some instruments have a variation that adds a different nuance to its sound.

The following section will explain how to use Instrument Variation.

● Instrument Variation

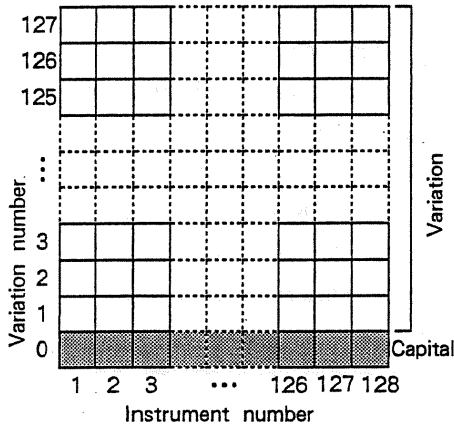

Using the Sound Canvas instruments that you have used until now as a foundation, the basic instrument is called "Capital", and the instrument that has a different nuance added to its sound is called "Variation".

The relationship between the Instrument number and the Variation number can be seen in the illustration on the left.

⇒ Refer to "Instrument Table" (P.66) to see which instrument has which kind of variation.

⇒ Instruments that have the same sound arrangement as the MT-32 (or CM-32L) are set to variation number 127.

< Variation of Instrument number 1—120 >

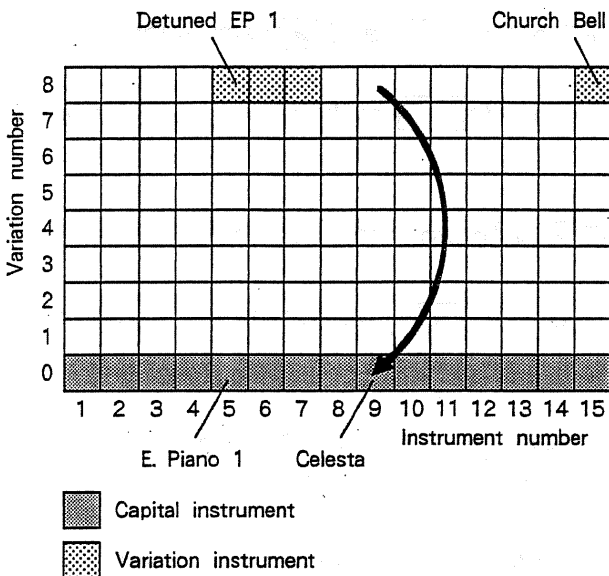

If you select an instrument for a part after altering the variation of the part, the instrument which is on the same line as the altered variation number will be selected. However, if you select an instrument that does not have a variation, the instrument capital will be substituted.

For example, if the current instrument is "E. Piano 1" (instrument number: 5) for part 1 and you change to variation number 8, "Detuned EP 1" of variation number 8 will be selected. Then if you change to instrument number 15, "Church Bell" will be selected. If you change to instrument number 9, since it has no variation, "Celesta" capital will be substituted.

⇒ When you specify variation number 63 and up, and the instrument is not assigned to its variation number, the capital instrument will not be substituted and no sound will be heard.

< Variation of Special Effect sounds (Instrument number 121—127) >

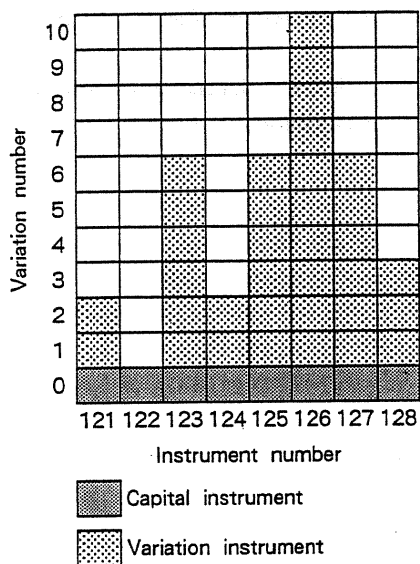

The operation of Special Effect sounds is different from other types of instruments.

Special Effect sounds such as “Falling rain” or “Laughter” are classified by instrument numbers according to their type. Capital is considered to be the foundation for other types of instruments, but Capital is considered to be one of the variations of Special Effect sounds. Therefore, when an instrument is not assigned to the variation number that you specified, the Capital instrument will not be substituted and no sound will be heard.

For example, if you change to instrument number 121 after changing to variation number 8 using another instrument, no sound will be heard because instrument number 121 is not assigned to variation number 8.

< Sub Capital >

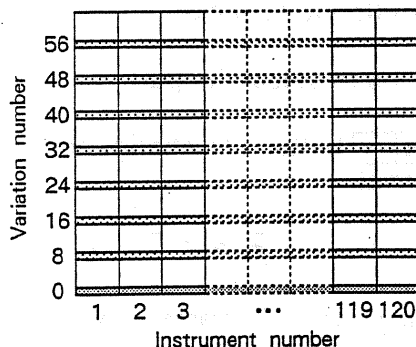

Sub Capital is a variation that, like capital, substitutes instruments when you change the variation. As is shown in the illustration on the left, the variation numbers in order from variation number 8 are designated as Sub Capital.

⇒ Sub Capital (or Capital) is substituted only to instrument numbers 1—120/ variation numbers 1—63.

If you change to another instrument number after selecting a variation number other than Sub Capital, Sub Capital or Capital will be substituted if the instrument is not assigned to its variation number. Which will be substituted is determined by the variation of the instrument number that you specified.

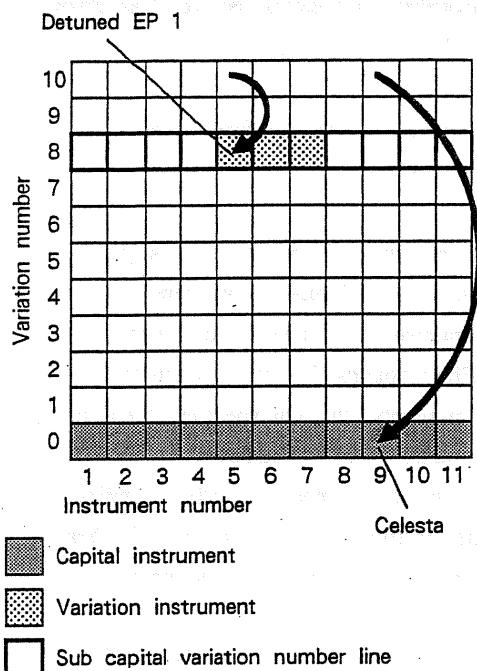

For example, When variation number 10 is selected and you change to instrument number 5, Sub Capital "Detuned EP-1" (contained in the specified variation number) will be substituted. Furthermore, if you change to instrument number 9, the instrument is not assigned to the Sub Capital which is contained in the specified variation number. Therefore, Capital "Celeste" will be substituted.

The instrument that is substituted will be different, depending on whether or not the instrument is assigned to the sub capital which is contained in the specified variation number.

● How to change the variation

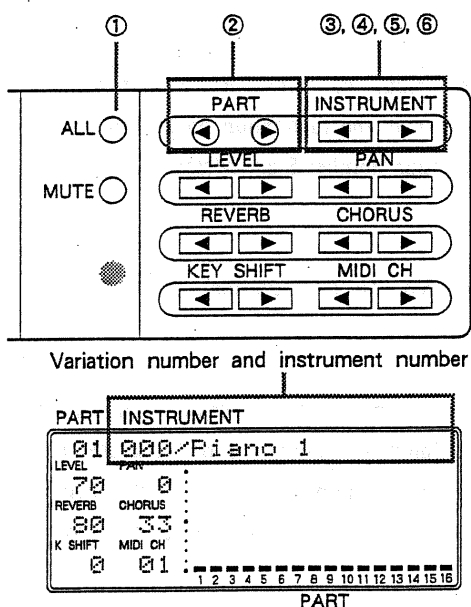

- ① Make sure that the **ALL** button indicator is off. If the indicator is on, press the button to turn it off.
- ② Use the **PART** buttons to select the part.
- ③ Use the **INSTRUMENT** buttons to change to an instrument containing a variation.
- ④ Press the **INSTRUMENT** buttons (and) simultaneously.
As soon as the displayed instrument number is changed to variation number, a "/" mark will be displayed in front of the instrument name and the variation can then be changed.
- ⑤ Use the **INSTRUMENT** buttons to change the variation.
- ⑥ Press the **INSTRUMENT** buttons (and) simultaneously to finalize.

⇒ When you want to return to the status in which instrument numbers can be changed, a mark will be displayed in front of the instrument name indicating what type of instrument has been selected.

Space: Capital

+ : variation number 1—126

: variation number 127 (MT-32 set)

⇒ An instrument number and variation number that has no instrument assigned to it, or Capital/Sub-capital is substituted cannot be selected.

● How to change the variation using an external MIDI device

The instrument number is changed by a program change message. The variation number is changed by the control 0/value (variation number) of the control change message.

- Ⓐ : Changing the variation of the instrument that has been selected
- Ⓑ : Changing to another instrument number (different variation number)
- Ⓒ : Returning to the Capital instrument

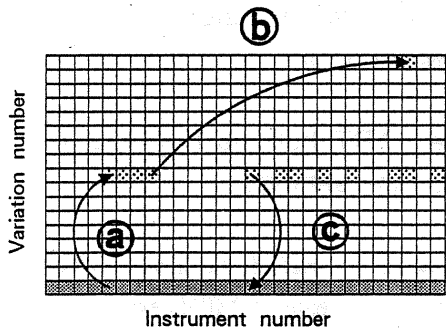

After you transmit the control number 0/value (specified variation number), transmit the program change message (program number of specified instrument number).

- Ⓓ : Changing to another instrument number (same variation number)

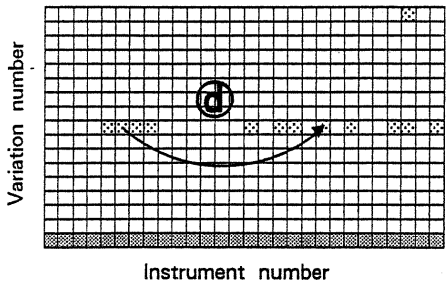

Transmit the program change message (program number of the desired instrument).

⇒ Refer to the owners manual of your MIDI device for information about transmitting program change messages/control change messages.

⇒ A mark will be displayed in front of the instrument name indicating what type of instrument has been selected.

Spec: Capital (variation number 0)

+ : Variation number 1 — 126

: Variation number 127 (MT-32 set)

⇒ When Capital/Sub Capital is substituted, the instrument name that is substituted will be shown in the display.

⇒ If you specify an instrument number to which Capital/Sub Capital is not assigned, no sound will be heard (the instrument name will not be displayed).

● When you don't want to change the instrument from the external MIDI device

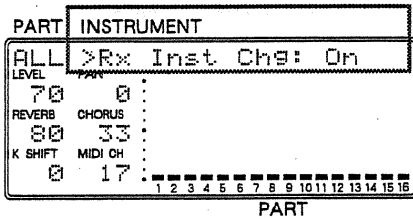
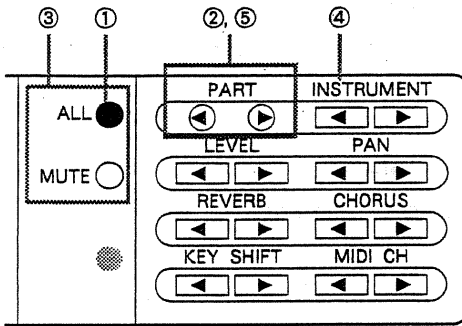

- ① Press **ALL** to turn the button indicator on.
- ② Press the PART buttons (◀ and ▶) simultaneously.
- ③ Use the **ALL** and **MUTE** buttons to select "Rx Inst Chg" (Instrument receiving switch).
- ④ Use the INSTRUMENT ◀ button to select "Off".
Press INSTRUMENT ▶ to reselect to "On".
- ⑤ After setting, press the PART buttons (◀ and ▶) simultaneously to finalize the settings.

⇒ When the instrument receiving switch is turned off, the instruments/drum set of all parts cannot be changed from an external MIDI device.

■ ALTERING THE SOUND

The sound of an instrument can be altered according to your taste.

□ Before altering the sound

The Sound Canvas contains parameters (elements) that are used to alter the sound. Altering the sound means editing the basic settings of each instrument. Therefore, even if the value of a parameter is the same, the effect may be different depending on the instrument that is selected.

Sound parameters are also set for each part. Therefore, if you change to another instrument after changing the value of a parameter, that instrument's sound will be changed. The normal method of operation is to change the value of the parameter for the part in which only one specified instrument is used.

□ The function of each parameter

● Vibrato

Vibrato adds a pitch-fluctuation effect to the sound.

Vibrato Rate : - 50 — + 50

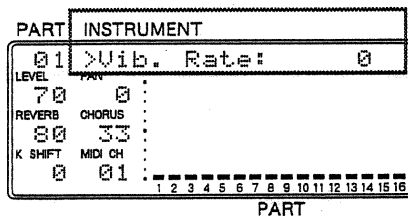

This determines the speed with which the pitch will fluctuate.

+ Values : Pitch fluctuations will be faster

- Values : Pitch fluctuations will be slower

Vibrato Depth : - 50 — + 50

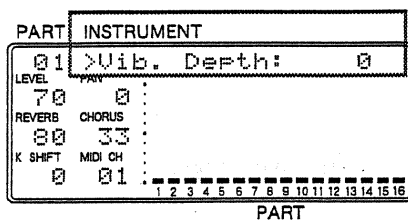

This determines the depth of the pitch fluctuations.

+ Values : Pitch fluctuations will be deeper

- Values : Pitch fluctuations will be shallower

Vibrato Delay : - 50 — + 50

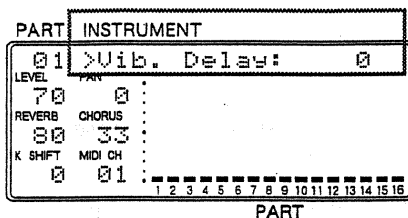

This adjusts the time delay after which the vibrato will begin.

+ Values : the time delay will be longer

- Values : the time delay will be shorter

● Nuances of the sound

Cutoff Freq. (Cutoff Frequency) : - 50 — + 16

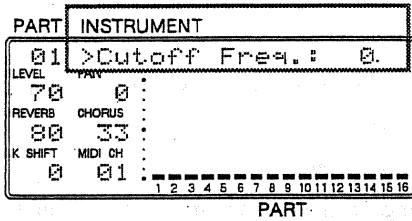

This parameter determines the frequency at which the overtone element of the sound is cut. The change may be completely different depending on the instrument that is selected.

Generally speaking, higher values usually result in a softer sound.

⇒ Most instrument sounds are created without a large cut in the overtone element. Raising the Cutoff Frequency of these instruments will not change the sound greatly.

Resonance : - 50 — + 50

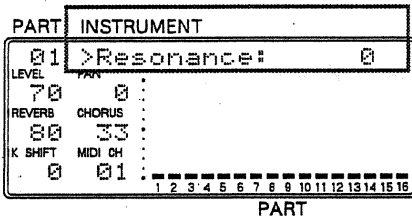

This parameter determines how much the overtone element which is cut by the Cutoff Freq. will be emphasized.

Generally speaking, higher values will result in a more peculiar synth-type sound.

● Envelope

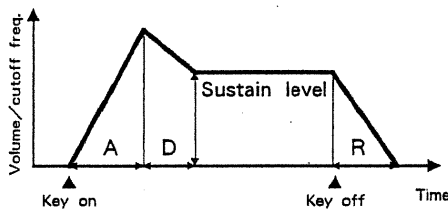

These settings create changes in volume and Cutoff Frequency over time.

A : Attack time

D : Decay time

R : Release time

Attack time : - 50 — + 50

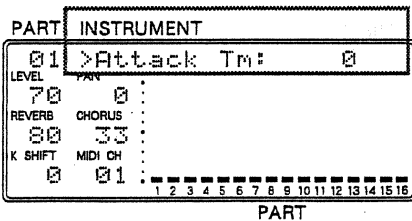

This setting determines the time at which the sound begins.

Decay time : - 50 — + 50

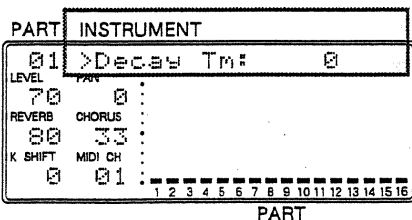

This setting determines the time at which the sustain level is reached.

* Use Release time to adjust the volume decrease on instruments that have a natural decay (such as piano and guitar).

● Release time : - 50 — + 50

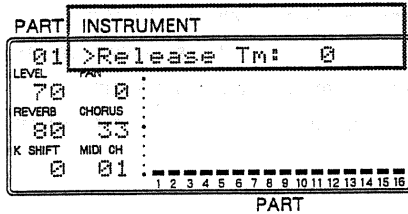

This setting determines the time at which the sound is released.

□ Setting instructions

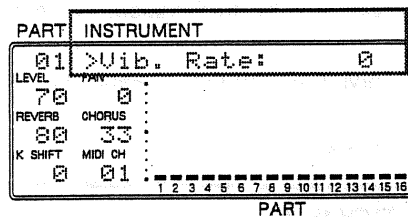
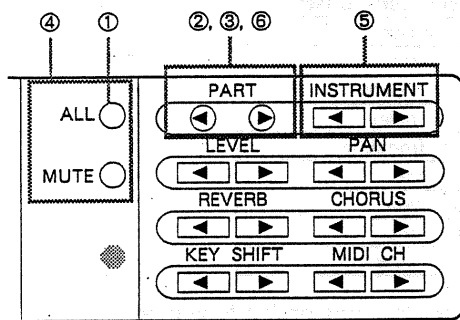

- ① Make sure that the **ALL** button indicator is off. If the indicator is on, press the button to turn it off.
- ② Press the PART buttons (◀ and ▶) simultaneously.
- ③ Use the PART ◀▶ buttons to select the part for setting.
- ④ Use the **ALL** and **MUTE** buttons to select the sound parameter.
 Vib. Rate
 Vib. Depth
 Vib. Delay
 Cutoff Freq.
 Resonance
 Attack Time
 Decay Time
 Release Time
- ⑤ Use the INSTRUMENT ◀▶ buttons to set the value.
- ⑥ After setting, press the PART buttons (◀ and ▶) simultaneously to finalize the settings.

STORING THE SOUND CANVAS'S SETTINGS TO A SEQUENCER

You can transmit the following settings as MIDI messages (exclusive messages) from the Sound Canvas. Use this function when you want to save the Sound Canvas's settings in a sequencer or other device. You can also store the settings to the head of song data, then when you load the song data to be played, it can be played without having to make any prior settings.

If you store edited sound data after the instrument change message, the specified instrument can be heard with its original sound.

Overall part settings	Part settings	
Volume level of all parts	Instrument selection	Part Mode
Pan of all parts	Drum part setting	Bend range
Reverb level of all parts	Reverb	Partial reserve
Chorus level of all parts	Chorus	Key range low
Key shift of all parts	Pan	Key range high
Master tune	Volume level	Velocity sens depth
Reverb type	Key shift	Velocity sens offset
Chorus type	MIDI channel	M/P mode
		Vibrato rate
		Vibrato depth
		Vibrato delay
		Cutoff frequency
		Resonance
		Attack time
		Decay time
		Release time

- * Whether or not exclusive messages can be transmitted and received correctly depends on the type of sequencer.
- * The above settings can be set using the Sound Canvas but other settings will also be transmitted. For more details, refer to the MIDI implementation (☞ P.74).
- * If you are using more than one Sound Canvas, transmit after changing the Device ID number of each unit (☞ P.53). The factory preset is 17.
- * The setting of the partial reserve for each part will be transmitted as the setting for all parts.

● How to transmit (All Sound Canvas settings)

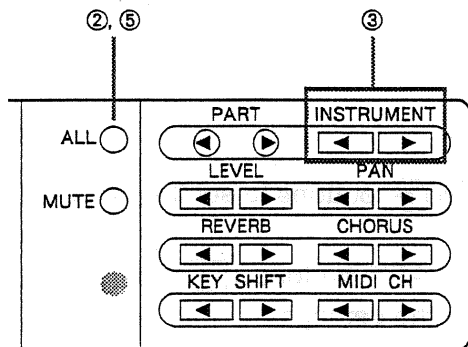

① Using a MIDI cable, connect MIDI OUT of the Sound Canvas to MIDI IN of the sequencer.

② Press **ALL** to turn the button indicator light on.

③ Press the INSTRUMENT buttons (◀ and ▶) simultaneously.
“Dump All, Sure?” will be shown in the display, and the Sound Canvas will be ready to transmit.

④ Start sequencer recording (Realtime recording).

⑤ Press **ALL** to transmit. (To stop the procedure, press **MUTE**.)

⑥ Stop sequencer recording.

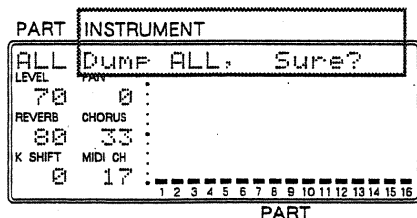

● How to transmit (all parts and specified part settings)

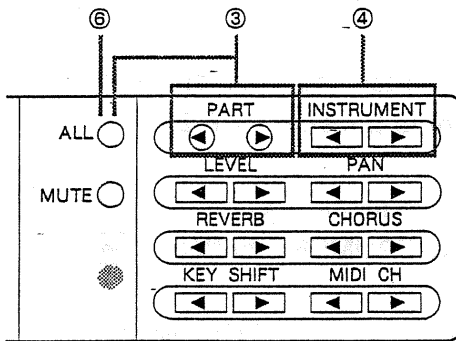

②

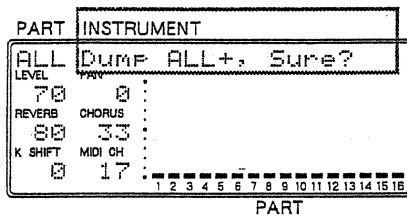

- ① Using a MIDI cable, connect MIDI OUT of the Sound Canvas to MIDI IN of the sequencer.
- ② After turning the **ALL** button indicator off, mute the part that you do not want to transmit (☞ P.25).
- ③ After turning the **ALL** button indicator on, press the **PART** buttons (◀ and ▶) simultaneously.
- ④ Press the **INSTRUMENT** buttons (◀ and ▶) simultaneously.
“Dump ALL+, Sure?” will be shown in the display, and the Sound Canvas will be ready to transmit.
- ⑤ Start sequencer recording (Realtime recording).
- ⑥ Press **ALL** to transmit. (To stop the procedure, press **MUTE**.)
- ⑦ Stop sequencer recording.

● How to transmit (the settings of a specified part)

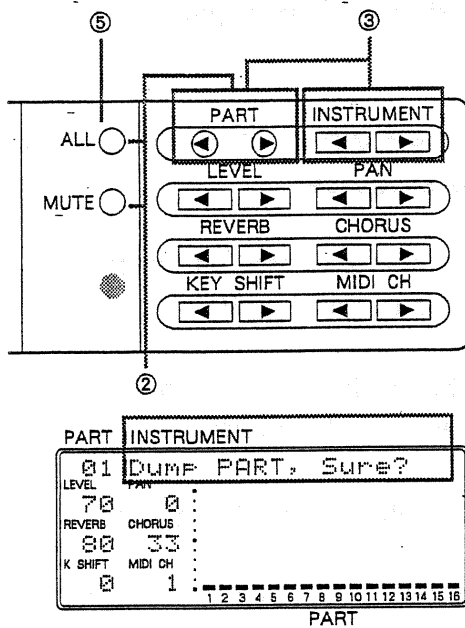

- ① Using a MIDI cable, connect MIDI OUT of the Sound Canvas to MIDI IN of the sequencer.
- ② After turning the **ALL** button indicator off, mute the part that you do not want to transmit (☞ P.25).
- ③ After pressing the PART buttons (◀ and ▶) simultaneously, press the INSTRUMENT buttons (◀ and ▶) simultaneously.
“Dump PART, Sure?” will be shown in the display, and the Sound Canvas will be ready to transmit.
- ④ Start sequencer recording (Realtime recording).
- ⑤ Press **ALL** to transmit. (To stop the procedure, press **MUTE**.)
- ⑥ Stop sequencer recording.

● How to receive

- ① Using a MIDI cable, connect MIDI IN of the Sound Canvas to MIDI OUT of the sequencer.
- ② It is not necessary to set the Sound Canvas to any special receiving status. Simply transmit the exclusive messages from the sequencer.

⇒ When you do not want to receive exclusive messages, turn the exclusive receiving switch off (☞ P.53).

⇒ If the Device ID number of the exclusive message that is transmitted does not match the Device ID number of the Sound Canvas (☞ P.53), the exclusive message cannot be received correctly.

Exclusive messages (P.60) have what is called a device ID number (sometimes called "unit number") to distinguish each device when many devices are being used. Device ID numbers are given the numbers 1—32 (factory preset 17). When only one Sound Canvas is used, it is not necessary to change the Device ID number. When you do not want to receive exclusive messages, turn the exclusive receiving switch off (factory preset on).

< When changing the Device ID number >

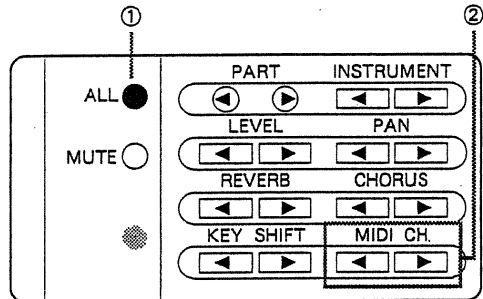

① Press **[ALL]** to turn the button indicator on.

② Use the MIDI CH **[◀▶]** buttons to change the Device ID number.

⇒ If you press MIDI CH **[◀▶]** simultaneously, the current setting will be shown on the bar display. Press MIDI CH **[◀▶]** again to return to the previous display.

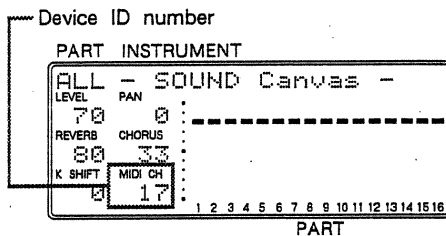

< When you do not want to receive exclusive messages >

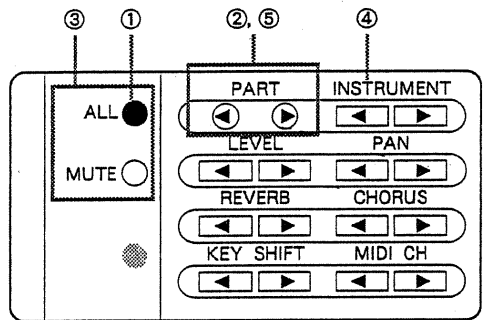

① Press **[ALL]** to turn the button indicator light on.

② Press the PART buttons (**[◀▶]**) simultaneously. "M. Tune" will be shown in the display where the instrument number and name are usually shown.

③ Use the **[ALL]** and **[MUTE]** buttons to select "Rx SysEx" (Exclusive receiving switch).

④ Press INSTRUMENT **[◀]** to turn the switch "Off". (To turn the switch "on", press INSTRUMENT **[▶]**.)

⑤ After setting, press the PART buttons (**[◀▶]**) simultaneously to finalize the setting.

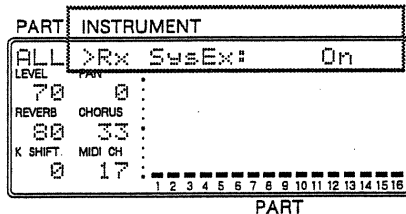

The following information is provided for your reference. It is not intended to be used as a substitute for the information provided in the manual. The information is provided for your reference only. It is not intended to be used as a substitute for the information provided in the manual. The information is provided for your reference only. It is not intended to be used as a substitute for the information provided in the manual.

Additional information

The following information is provided for your reference. It is not intended to be used as a substitute for the information provided in the manual. The information is provided for your reference only. It is not intended to be used as a substitute for the information provided in the manual. The information is provided for your reference only. It is not intended to be used as a substitute for the information provided in the manual.

Additional information

The following information is provided for your reference. It is not intended to be used as a substitute for the information provided in the manual. The information is provided for your reference only. It is not intended to be used as a substitute for the information provided in the manual. The information is provided for your reference only. It is not intended to be used as a substitute for the information provided in the manual.

The following information is provided for your reference. It is not intended to be used as a substitute for the information provided in the manual. The information is provided for your reference only. It is not intended to be used as a substitute for the information provided in the manual.

Appendix

APPENDIX

■ TROUBLESHOOTING

If the Sound Canvas does not perform as expected, please check the following points. If you cannot solve the problem, discontinue use immediately, contact your Roland dealer or a nearby Roland service station as soon as possible.

⇒ If an error message appears in the display during operation, refer to the error message table on the following page.

● Cannot turn the power on

Be sure to use only the included AC adaptor.

● No sound

Is the power to the connected devices turned on?

Is the volume knob turned all the way down?

Can you hear sound in the headphones? If not, the problem is probably in the cable, amp, or mixer.

Is the sound of all parts muted (☐ P.25)?

Is the volume level of all parts too low (☐ P.15)?

Is an external device using an expression pedal which is turned down?

● A specified part cannot be heard

Is the sound of that part muted (☐ P.25)?

Is the volume level of the part too low (☐ P.23)?

Does the part's MIDI receive channel match the MIDI transmit channel of the external device?

● Notes within a specified range cannot be heard

Has the Key Range been set (☐ P.37)?

● The pitch is wrong

Is the Master Tune setting correct (☐ P.27)?

Does the pitch of all parts differ by more than one semitone (☐ P.17)?

Is the pitch of the specified part off by more than one semitone (☐ P.24)?

Has pitch bend data been received, leaving the pitch "hanging" at some non-zero value? Return the bender to the center position or transmit the center value (63) of the pitch bend message.

● The instrument cannot be changed

Is the instrument receiving switch turned off (☐ P.46)?

● The instruments sound strange

Have you changed to another instrument after editing the sound? Set all sound parameter values to 0 (☐ P.36, 47).

● Notes of an important part are cut off

Change the partial reserve settings (☐ P.41).

● Exclusive messages cannot be received

Is the exclusive message receiving switch turned off (☐ P.53)?

Does the Device ID number of the exclusive message that you are sending match the Device ID number of the Sound Canvas? (☐ P.53)

■ ERROR MESSAGES

If you attempt to execute an incorrect operation or if some unexpected condition occurs, one of the following error messages will appear in the display (in the area that normally displays the instrument name and number).

Refer to this list, and take the appropriate action.

- Battery Low!** Reason : The internal memory backup battery is low.
Action : Consult the nearest Roland service station.
- Address Error!** Reason : The address of the exclusive message that is being received is incorrect.
- DT1 Data Error!** Reason : DT I (Data Set 1) data that is being received is incorrect.
- RQ1 Size Error!** Reason : The size of RQ 1 (Data Requirement 1) data that is being received is incorrect.
- Check Sum Error!** Reason : The Check Sum that is being received is incorrect.
Action : Check the data that is being transmitted and try the operation again. Also, make sure the MIDI cable isn't unplugged, broken, or shorted.
- MIDI Buff. Full!** Reason : A large amount of MIDI data was received in a short time and could not be processed.
Action : Check that the transmitting device is not transmitting excessive amounts of MIDI data.
- MIDI Off Line!** Reason 1 : The MIDI device connected to MIDI IN has been turned off.
Action 1 : This is not a malfunction.
Reason 2 : It is possible that the MIDI cable connected to MIDI IN has been pulled out, or damaged.
Action 2 : Check the MIDI cable connections.

■ ABOUT MIDI

MIDI (Musical Instrument Digital Interface) is a world-wide standard that provides a way for electronic musical instruments to communicate. Instruments that have MIDI connectors can be connected to any other MIDI device, regardless of the manufacturer or model, and exchange musical data as "MIDI messages".

□ How MIDI messages are transmitted and received

● MIDI connectors

Three types of connectors are used to transmit and receive MIDI messages. Depending on your setup, you can use MIDI cables to connect your equipment in various ways.

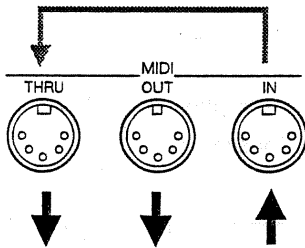

MIDI IN : This connector receives messages from another MIDI device itself.

MIDI OUT : This connector transmits messages from the device itself.

MIDI THRU: This connector re-transmits the messages from MIDI IN, exactly as they were received.

* MIDI THRU connectors can be used to "daisy-chain" any number of MIDI devices. However in practice, four or five units is the limit. When the MIDI signal is passed through many THRU connectors, it may become unreadable.

● MIDI channels

MIDI uses "channels" to independently control many devices through a single cable. You may think of MIDI channels as being similar to television channels. Electrical signals come into a television set from the antenna on many different channels at once, but only the channel to which the TV is tuned will be received.

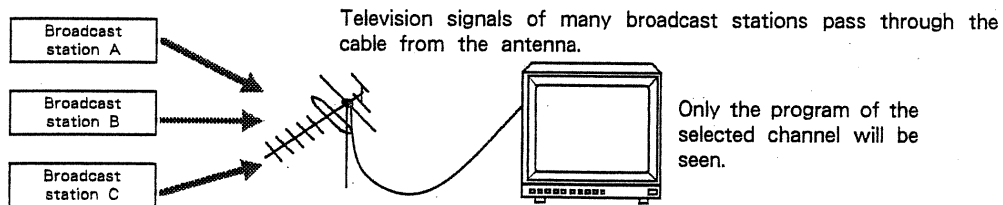

MIDI provides sixteen channels (1—16) on which messages can be sent. Messages will be received only by instruments which are set to receive the matching channel. For example, with the MIDI channel settings in the following illustration, playing the keyboard will play only sound module B.

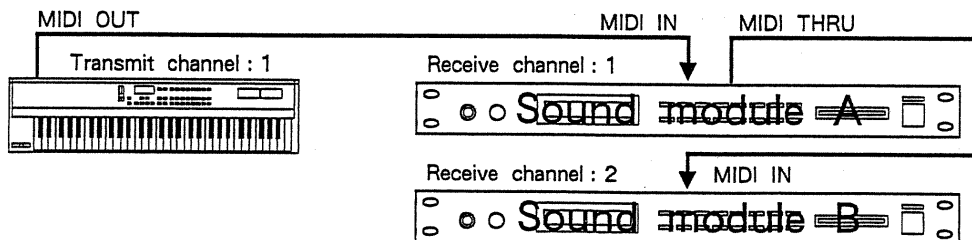

□ MIDI messages used by the Sound Canvas

The various types of data transmitted and received via MIDI are called MIDI messages. MIDI messages can be broadly divided into two types; messages that are transmitted on a specific channel (Channel messages), and messages that carry information which applies to an entire MIDI system (System messages).

● Channel messages

Channel messages are used to convey musical actions, such as notes you play and controllers you move. Most MIDI messages fall into this category. The settings of the sound source will determine how it will produce sound in response to these messages.

Note messages

Note messages are transmitted when you play the keyboard. Each message contains information indicating which key was pressed (the note number) and how strongly it was pressed (the velocity). When you release a key, a similar message is sent, indicating which key was released.

Note number	A number indicating the note (key) that was pressed or released
Note on	A message indicating that a note (key) was pressed
Note off	A message indicating that a note (key) was released
Velocity	A number indicating how strongly the note (key) was pressed

Notes are numbered from 0—127, with middle C (C4) as 60. A different note number is assigned to each percussion sound in the drum part. Each note number will play a different percussion sound.

Pitch Bend messages

Pitch Bend messages are transmitted when you move the pitch bend lever (wheel) found on most synthesizers.

Aftertouch messages

Aftertouch messages are transmitted when you press down on the keyboard (of a synthesizer that is able to transmit aftertouch messages) after playing a note. There are two types of aftertouch; Channel aftertouch and Polyphonic aftertouch.

Channel aftertouch is transmitted as a single value for the entire keyboard, and applies to an entire MIDI channel. All notes receiving that MIDI channel will respond in the same way regardless of which key you apply pressure to.

Polyphonic aftertouch is transmitted independently for each key (note). Even for the same MIDI channel, only the note to which you apply pressure will be affected.

Program Change messages

Program change messages are used to change instruments. Instruments using program numbers 1—128 will be changed by program change messages. The Sound Canvas also uses control change messages to change the variation of an instrument.

■ ABOUT GS STANDARD

GS Standard was created in an attempt to standardize the way in which sound modules are controlled by MIDI. This section will give you a simple overview of GS Standard.

□ What is GS Standard

Until now, concerning the correspondence of instruments, how the sound was produced and various controller operations were different, depending on the MIDI sound module devices. Therefore, the user had to have a clear understanding of the operation of each device and how they corresponded when connected.

Sometimes, song data that was created by using one particular MIDI sound module could not be reproduced as expected on another MIDI sound module. The transmission and reception of MIDI messages has been standardized by "MIDI Standard" but operations that affect the way sound is heard were not always compatible between units.

To solve this problem, Roland introduces GS Standard which was created to standardize the way in which sound modules are controlled by MIDI.

If a device contains a sound module that conforms to GS Standard, it is possible to reproduce the performance that was created on another GS Standard device. GS Standard was designed with careful consideration of future development, and GS Standard will be incorporated into many devices from now on.

Devices that contain sound modules that conform to GS Standard will have the GS Standard mark on their panel.

□ The main features of GS Standard

● 16 part multi-timbral sound module

GS Standard devices contain a 16-part multi-timbral sound module that utilizes full MIDI channel support. You can assign a different instrument to each part and therefore enjoy ensemble performance by using the instruments of each part.

● An abundance of internally stored instrument sounds and instrument specification exchangeability (☞ P.42, 66).

GS Standard contains standard instruments (Capital) that can be used to reproduce many various styles of music, such as: classical, jazz, rock, popular, and ethnic, as well as instrument variations that make use of device features and future expansion.

There is exchangeability to specify instruments even to the device that has a different correspondence of variation.

GS Standard also contains many drum set types that incorporate various percussion sounds thus making it possible to choose the drum set that is most suitable for a particular song.

● 24 guaranteed simultaneous notes (☞ P.40)

GS Standard does not prescribe to any one specified sound module method so there is no limit to the maximum simultaneous notes that can be played.

However, GS Standard does guarantee that at least 24 notes can be played simultaneously.

Also, most acoustic sounds consist of only one partial and were created with careful consideration as to how they can be used with each part most effectively thus surpassing earlier sound module methods.

● Completion of MIDI control functions

GS Standard corresponds to various MIDI messages that are indispensable for playing expression such as Mono mode and Portamento. It is also possible to control most MIDI messages that are necessary for performance without using exclusive messages.

□ General functions of GS Standard

Number of parts	: 16
Maximum number of simultaneous notes	: 24 (partials) and up
Instrument specification	: GS Standard makes the specification of instruments possible by combining previously developed program change messages with control change messages (bank select) thus increasing the type of instruments that can be changed by an external device. This instrument specification exchangeability is possible even if there is a difference in the variation of other devices.
Drum Set	: The drum set can be changed with the program change message.
Effects	: GS Standard contains adjustable Reverb and Chorus effects.

TABLE OF OPERATIONS

● All parts and System function settings (When the **ALL** indicator is on)

All parts	Volume Level	0—127	LEVEL ◀▶	P.15
	Pan	L63—0—R63	PAN ◀▶	P.15
	Reverb	0—64—127	REVERB ◀▶	P.16
	Chorus	0—64—127	CHORUS ◀▶	P.16
	Key Shift	- 24—0—+ 24	KEY SHIFT ◀▶	P.17
	Master Tune	415.3— 440.0 —466.2Hz		P.27
All parts	Reverb Type	Room1, 2, 3 Hall1, 2 Plate Delay Panning Delay	PART ◀ * Part ▶ → (ALL MUTE): Function selection → INSTRUMENT ◀▶: Set → PART ◀ * Part ▶: Execute	P.36
	Chorus Type	Chorus1, 2, 3, 4 Feedback Chorus Flanger Short Delay Short Delay (FB)		P.36
System function	Rx. Inst Chg	Off, On		P.46
	Rx. SysEx	Off, On		P.53
	Rx GS Reset	Off, On		P.33
	Display	Type1—8		P.29
	Peak Hold	Off, Type1—3		P.29
	LCD Contrast	1—8—16		P.28
	Back Up	Off, On		P.34
	Rx Remote	Off, On		P.11
	Device ID number	1—17—32	MIDI CH ◀▶	P.53

- : Proceed to the next instruction
- ◻ A * ◻ B : Press ◻ A and ◻ B simultaneously.
- ◀ ▶ : Repeat the operation.

* Bold-faced values are the factory presets.

● Settings for each part (When the **ALL** indicator is off)

Instrument Selection	1—128	PART ◀▶ : Part selection → INSTRUMENT ◀▶	P.14
Drum Set Selection	---	PART ◀▶ : Drum part selection → INSTRUMENT ◀▶	P.20
Volume Level	0—100—127	PART ◀▶ : Part selection → LEVEL ◀▶	P.23
Pan	Rnd, L63—0—R63	PART ◀▶ : Part selection → PAN ◀▶	P.23
Reverb	0—40—127	PART ◀▶ : Part selection → REVERB ◀▶	P.23
Chorus	0—127	PART ◀▶ : Part selection → CHORUS ◀▶	P.24
Key Shift	- 24—0— + 24	PART ◀▶ : Part selection → KEY SHIFT ◀▶	P.24
MIDI Receive Channel	1—16, Off	PART ◀▶ : Part selection → MIDI CH ◀▶	P.35
Part Mode	Norm, Drum1, Drum2	PART ◀ * PART ▶ → PART ◀▶ : Part selection → (ALL MUTE): Function selection → INSTRUMENT ◀▶ : Set) → PART ◀ * PART ▶ : Execute	P.21
Bend Range	0—+2— + 24		P.37
Modulation Depth	0—10—127		P.37
Key Range L	C-1—G9		P.37
Key Range H	C-1—G9		P.37
Velocity Sens Depth	0—64—127		P.38
Velocity Sens Offset	0—64—127		P.38
Partial Reserve	0—2—24		P.41
M/P Mode	Poly , Mono		P.39
Vib. Rate	- 50—0— + 50		P.47
Vib. Depth	- 50—0— + 50		P.47
Vib. Delay	- 50—0— + 50		P.47
Cutoff Freq.	- 50—0— + 16		P.48
Resonance	- 50—0— + 50		P.48
Attack Time	- 50—0— + 50		P.48
Decay Time	- 50—0— + 50		P.48
Release Time	- 50—0— + 50	P.49	

- : Proceed to the next instruction
- A** + **B** : While holding **A**, press **B**.
- A** * **B** : Press **A** and **B** simultaneously.
- ⟨ ⟩ : Repeat the operation.

* Bold-faced values are the factory presets that are common for each part.

● Other functions

Making the GS standard setting		INSTRUMENT + Turn the power on \Rightarrow	P.33
Sound arrangement of MT-32		INSTRUMENT + Turn the power on \Rightarrow	P.32
Returning to factory preset	All Sound Canvas settings	INSTRUMENT * INSTRUMENT + POWER SUPPLY ON : execute	P.34
Transmit Sound Canvas settings	All settings of the Sound Canvas	: indicator on \Rightarrow INSTRUMENT * INSTRUMENT \Rightarrow : execute	P.50
	All parts and settings of the specified part	: indicator off \Rightarrow \langle PART \rangle : select the part that you do not transmit \Rightarrow Mute on \Rightarrow : indicator on \Rightarrow PART * PART \Rightarrow INSTRUMENT * INSTRUMENT \Rightarrow : execute	P.51
	Specified part settings	: indicator light off \Rightarrow \langle PART \rangle : select the part that you do not transmit \Rightarrow Mute on \Rightarrow PART * PART \Rightarrow INSTRUMENT * INSTRUMENT \Rightarrow : execute	P.52
ROM play	Set to ROM play status	PART * PART + power on	P.13
	Select song	PART	
	Play start		
	Play stop		
	Cancel ROM play status	PART * PART	
Selection of variation		: Indicator light off \Rightarrow PART : select the part that you want to change \Rightarrow INSTRUMENT : change to an instrument that has variation \Rightarrow INSTRUMENT * \Rightarrow INSTRUMENT : Select variation \Rightarrow INSTRUMENT *	P.44

- \Rightarrow : Proceed to the next instruction
- + : While holding , press
- * : Press and simultaneously
- * + power on : While holding and simultaneously, turn the power on.
- $\langle \rangle$: Repeat this operation

INSTRUMENT TABLE

● Capital (variation : 0)

	PC #	Instrument name	P	Recommended sound range		PC #	Instrument name	P	Recommended sound range
Piano	1	Piano 1	1	A0 (21) — C8 (108)	Bass	33	Acoustic Bs.	1	E1 (28) — G3 (55) *
	2	Piano 2	1	A0 (21) — C8 (108)		34	Fingered Bs.	1	E1 (28) — G3 (55) *
	3	Piano 3	1	A0 (21) — C8 (108)		35	Picked Bs.	1	E1 (28) — G3 (55) *
	4	Honky-tonk	2	A0 (21) — C8 (108)		36	Fretless Bs.	1	E1 (28) — G3 (55) *
	5	E. Piano 1	1	C2 (36) — C7 (96)		37	Slap Bs. 1	1	E1 (28) — G3 (55) *
	6	E. Piano 2	1	C2 (36) — C7 (96)		38	Slap Bs. 2	1	E1 (28) — G3 (55) *
	7	Harpsichord	1	F2 (41) — F6 (89)		39	Synth Bass 1	1	E1 (28) — G3 (55) *
	8	Clav.	1	C2 (36) — C7 (96)		40	Synth Bass 2	1	E1 (28) — G3 (55) *
Chromatic Percussion	9	Celesta	1	C4 (60) — C8 (108) *	Strings/orchestra	41	Violin	1	G3 (55) — C7 (96)
	10	Glockenspiel	1	C5 (72) — C8 (108) *		42	Viola	1	G3 (48) — C6 (84)
	11	Music Box	1	C4 (60) — C6 (84)		43	Cello	1	C2 (36) — C5 (72)
	12	Vibraphone	1	F3 (53) — F6 (89) *		44	Contrabass	1	E1 (28) — G3 (55) *
	13	Marimba	1	C3 (48) — C6 (84)		45	Tremolo Str	1	E1 (28) — C7 (96)
	14	Xylophone	1	F4 (65) — C7 (96) *		46	PizzicatoStr	1	E1 (28) — C7 (96)
	15	Tubular-bell	1	C4 (60) — F5 (77) *		47	Harp	1	B0 (23) — G7 (103)
	16	Santur	1	C4 (60) — C6 (84)		48	Timpani	1	C2 (36) — A3 (57)
Organ	17	Organ 1	1	C2 (36) — C7 (96)	Ensemble	49	Strings	1	E1 (28) — C7 (96)
	18	Organ 2	1	C2 (36) — C7 (96)		50	Slow Strings	1	E1 (28) — C7 (96)
	19	Organ 3	1	C2 (36) — C7 (96)		51	Syn. Strings1	1	C2 (36) — C7 (96)
	20	Church Org. 1	1	A0 (21) — C8 (108)		52	Syn. Strings2	2	C2 (36) — C7 (96)
	21	Reed Organ	1	C2 (36) — C7 (96)		53	Choir Aahs	1	C3 (48) — G5 (79)
	22	Accordion Fr	2	F3 (53) — F6 (89)		54	Voice Oohs	1	C3 (48) — G5 (79)
	23	Harmonica	1	C4 (60) — C6 (84)		55	SynVox	1	C3 (48) — C6 (84)
	24	Bandneon	2	F3 (53) — F6 (89)		56	OrchestraHit	2	C3 (48) — C5 (72)
Guitar	25	Nylon-str. Gt	1	E2 (40) — C6 (84) *	Brass	57	Trumpet	1	A # 3 (58) — A # 6 (94) *
	26	Steel-Str. Gt	1	E2 (40) — C6 (84) *		58	Trombone	1	A # 1 (34) — D # 5 (75) *
	27	Jazz Gt.	1	E2 (40) — D6 (86) *		59	Tuba	1	F1 (29) — G3 (55) *
	28	Clean Gt.	1	E2 (40) — D6 (86) *		60	MutedTrumpet	1	A # 3 (58) — A # 5 (82) *
	29	Muted Gt.	1	E2 (40) — D6 (86) *		61	French Horn	2	F2 (41) — F5 (77) *
	30	Overdrive Gt	1	E2 (40) — D6 (86) *		62	Brass 1	1	C2 (36) — C7 (96)
	31	DistortionGt	1	E2 (40) — D6 (86) *		63	Synth Brass1	2	C2 (36) — C7 (96)
	32	Gt. Harmonics	1	E2 (40) — D6 (86) *		64	Synth Brass2	2	C2 (36) — C7 (96)

PC # : Program number (instrument number)

P : Number of partials

* : The actual note number is different from what is shown

	PC #	Instrument name	P	Recommended sound range		PC #	Instrument name	P		
Lead	65	Soprano sax	1	F # 3 (54) — D # 6 (87)		97	Ice Rain	2		
	66	Alto sax	1	C # 3 (49) — G # 5 (80)		98	Soundtrack	2		
	67	Tenor sax	1	F # 2 (42) — D # 5 (75)		99	Crystal	2		
	68	Baritone sax	1	C # 2 (37) — G # 4 (68)		100	Atmosphere	2		
	69	Oboe	1	A # 3 (58) — G6 (91)		101	Brightness	2		
	70	English Horn	1	E3 (52) — A5 (81)		102	Goblin	2		
	71	Bassoon	1	A # 1 (34) — C5 (72)		103	Echo Drops	1		
	72	Clarinet	1	D3 (50) — G6 (91)		104	Star Theme	2		
Pipe	73	Piccolo	1	D5 (74) — C8 (108)		Synth SFX	105	Sitar	1	
	74	Flute	1	C4 (60) — C7 (96)			106	Banjo	1	
	75	Recorder	1	C5 (60) — C7 (96)			107	Shamisen	1	
	76	Pan flute	1	C4 (60) — C7 (96)			108	Koto	1	
	77	Bottle Blow	2	C4 (60) — C7 (96)			109	Kalimba	1	
	78	Shakuhachi	2				110	Bag Pipe	1	
	79	Whistle	1				111	Fiddle	1	
	80	Ocarina	1				112	Shanai	1	
Synth lead	81	Square Wave	2				Ethnic	113	Tinkle Bell	1
	82	Saw Wave	2					114	Agogo	1
	83	Syn. Calliope	2					115	Steel Drums	1
	84	Chiffer Lead	2					116	Woodblock	1
	85	Charang	2			117		Taiko	1	
	86	Solo Vox	2			118		Melo Tom 1	1	
	87	5th Saw Wave	2			119		Synth Drum	1	
	88	Bass & Lead	2			120		Reverse: Cym.	2	
Synth pad etc.	89	Fantasia	2			Percussive		121	Gt. FretNoise	1
	90	Warm Pad	1					122	Fl. Keyclick	1
	91	Polysynth	2					123	Seashore	1
	92	Space Voice	1					124	Bird	2
	93	Bowed Glass	2		125		Telephone 1	1		
	94	Metal Pad	2		126		Helicopter	1		
	95	Halo Pad	2		127		Applause	2		
	96	Sweep Pad	1		128		Gun Shot	1		

PC # : Program number (instrument number)

P : Number of partials

● Variation

PC #	CC0	Instrument name	P	Recommended sound range
5	8	Detuned EP 1	2	C2 (36) — C7 (96)
6	8	Detuned EP 2	2	C2 (36) — C7 (96)
7	8	Coupled Hps.	2	F2 (41) — F6 (89)
15	8	Church Bell	1	C4 (60) — F5 (77)
17	8	Detuned Or. 1	2	C2 (36) — C7 (96)
18	8	Detuned Or. 2	2	C2 (36) — C7 (96)
20	8	Church Org. 2	2	A0 (21) — C8 (108)
22	8	Accordion It	2	F3 (53) — F6 (89)
25	8	Ukulele	1	
26	8	12-str. Gt	2	E2 (40) — C6 (84)
	16	Mandolin	1	G3 (55) — E6 (88)
27	8	Hawaiian Gt.	1	E2 (40) — D6 (86)
28	8	Chorus Gt.	2	E2 (40) — D6 (86)
29	8	Funk Gt.	1	E2 (40) — D6 (86)
31	8	Feedback Gt.	2	E2 (40) — D6 (86)
32	8	Gt. Feedback	1	E2 (40) — D6 (86)
39	8	Synth Bass 3	1	E1 (28) — G3 (55)
40	8	Synth Bass 4	2	E1 (28) — G3 (55)
49	8	Orchestra	2	C1 (24) — C7 (96)
51	8	Syn. Strings3	2	C1 (24) — C7 (96)
62	8	Brass 2	2	C2 (36) — C7 (96)
63	8	Synth Brass3	2	C2 (36) — C7 (96)
64	8	Synth Brass4	1	C2 (36) — C7 (96)
108	8	Taisho Koto	2	
116	8	Castanets	1	
117	8	Concert BD	1	
118	8	Melo Tom 2	1	
119	8	808 Tom	1	

PC #	CC0	Instrument name	P
121	0	Gt. FretNoise	1
	1	Gt. Cut Noise	1
	2	String Slap	1
122	0	Fl. Keyclick	1
123	0	Seashore	1
	1	Rain	2
	2	Thunder	1
	3	Wind	1
	4	Stream	2
124	5	Bubble	2
	0	Bird	2
	1	Dog	1
124	2	Horse	1
	0	Telephone 1	1
125	1	Telephone 2	1
	2	DoorCreaking	1
	3	Door	1
	4	Scratch	1
	5	Windchime	2
126	0	Helicopter	1
	1	Car-engine	1
	2	Car-stop	1
	3	Car-pass	1
	4	Car-crash	2
	5	Siren	1
	6	Train	1
	7	Jetplane	2
	8	Starship	2
9	Burst Noise	2	
127	0	Applause	2
	1	Laughing	1
	2	Screaming	11
	3	Punch	1
	4	Heart Beat	1
128	5	Footstep	1
	0	Gun Shot	1
	1	Machinegun	1
	2	Lasergun	1
128	3	Explosion	2

PC # : Program number (instrument number)

P : Number of partials

● Variation : MT-32 set (variation : 127)

PC#	Instrument name	P	PC#	Instrument name	P	PC#	Instrument name	P	PC#	Instrument name	P
1	Acou Piano 1	1	33	Fantasy	2	65	Acou Bass 1	1	97	Brs Sect 2	2
2	Acou Piano 2	1	34	Harmo Pan	2	66	Acou Bass 2	1	98	Vibe 1	1
3	Acou Piano 3	1	35	Chorale	1	67	Elec Bass 1	1	99	Vibe 2	-1
4	Elec Piano 1	1	36	Glasses	2	68	Elec Bass 2	1	100	Syn Mallet	1
5	Elec Piano 2	1	37	Soundtrack	2	69	Slap Bass 1	1	101	Windbell	2
6	Elec Piano 3	1	38	Atmosphere	2	70	Slap Bass 2	1	102	Glock	1
7	Elec Piano 4	1	39	Warm Bell	2	71	Fretless 1	1	103	Tube Bell	1
8	Honkytonk	2	40	Funny Vox	1	72	Fretless 2	1	104	Xylophone	1
9	Elec Org 1	1	41	Echo Bell	2	73	Flute 1	1	105	Marimba	1
10	Elec Org 2	2	42	Ice Rain	2	74	Flute 2	1	106	Koto	1
11	Elec Org 3	1	43	Oboe 2001	2	75	Piccolo 1	1	107	Sho	2
12	Elec Org 4	1	44	Echo Pan	2	76	Piccolo 2	2	108	Shakuhachi	2
13	Pipe Org 1	2	45	Doctor Solo	2	77	Recorder	1	109	Whistle 1	2
14	Pipe Org 2	2	46	School Daze	1	78	Pan Pipes	1	110	Whistle 2	1
15	Pipe Org 3	2	47	Bellsinger	1	79	Sax 1	1	111	Bottleblow	2
16	Accordion	2	48	Square Wave	2	80	Sax 2	2	112	Breathpipe	1
17	Harpsi 1	1	49	Str Sect 1	1	81	Sax 3	1	113	Timpani	1
18	Harpsi 2	2	50	Str Sect 2	1	82	Sax 4	1	114	Melodic Tom	1
19	Harpsi 3	1	51	Str Sect 3	1	83	Clarinet 1	1	115	Deep Snare	1
20	Clavi 1	1	52	Pizzicato	1	84	Clarinet 2	1	116	Elec Perc 1	1
21	Clavi 2	1	53	Violin 1	1	85	Oboe	1	117	Elec Perc 2	1
22	Clavi 3	1	54	Violin 2	1	86	Engl Horn	1	118	Taiko	1
23	Celesta 1	1	55	Cello 1	1	87	Bassoon	1	119	Taiko Rim	1
24	Celesta 2	1	56	Cello 2	1	88	Harmonica	1	120	Cymbal	1
25	Syn Brass 1	2	57	Contrabass	1	89	Trumpet 1	1	121	Castanets	1
26	Syn Brass 2	2	58	Harp 1	1	90	Trumpet 2	1	122	Triangle	1
27	Syn Brass 3	2	59	Harp 2	1	91	Trombone 1	2	123	Orche Hit	1
28	Syn Brass 4	2	60	Guitar 1	1	92	Trombone 2	2	124	Telephone	1
29	Syn Bass 1	1	61	Guitar 2	1	93	Fr Horn 1	2	125	Bird Tweet	1
30	Syn Bass 2	2	62	Elec Gtr 1	1	94	Fr Horn 2	2	126	One Note Jam	1
31	Syn Bass 3	2	63	Elec Gtr 2	1	95	Tuba	1	127	Water Bell	2
32	Syn Bass 4	1	64	Sitar	2	96	Brs Sect 1	1	128	Jungle Tune	2

PC# : Program number (instrument number)

P : Number of partials

DRUM SET TABLE

Note number	1:Standard Set 33:Jazz Set	9:Room Set	17:Power Set	25:Electronic Set	26:TR-808 Set	41:Brush Set	49:Orchestra Set
27	High O						Closed Hi-Hat [EXC1]
28	Slap						Pedal Hi-Hat [EXC1]
29	Scratch Push						Open Hi-Hat [EXC1]
30	Scratch Pull						Hi-Cymbal
31	Sticks						
32	Square Click						
33	Metronome Click						
34	Metronome Bell						
35	Kick Drum 2						Concert BD 2
36	Kick Drum 1		MONDO Kick	Elec BD	808 Bass Drum		Concert BD 1
37	Side Stick				808 Rim-Shot		
38	Snare Drum 1		Dated SD	Elec SD	808 Snare Drum	Brush Tap	Concert SD
39	Hand Clap					Brush Slap	Castanets
40	Snare Drum 2			Gated SD		Brush Swirl	Concert SD
41	Low Tom 2	Room Low Tom 2	Room Low Tom 2	Elec Low Tom 2	808 Low Tom 2		Timpani F
42	Closed Hi - hat [EXC1]				808 CHH [EXC1]		Timpani F#
43	Low Tom 1	Room Low Tom 1	Room Low Tom 1	Elec Low Tom 1	808 Low Tom 1		Timpani G
44	Pedal Hi - hat [EXC1]				808 CHH [EXC1]		Timpani G#
45	Mid Tom 2	Room Mid Tom 2	Room Mid Tom 2	Elec Mid Tom 2	808 Mid Tom 2		Timpani A
46	Open Hi - hat [EXC1]				808 DHH [EXC1]		Timpani A#
47	Mid Tom 1	Room Mid Tom 1	Room Mid Tom 1	Elec Mid Tom 1	808 Mid Tom 1		Timpani B
48	High Tom 2	Room Hi Tom 2	Room Hi Tom 2	Elec Hi Tom 2	808 Hi Tom 2		Timpani C
49	Crash Cymbal 1				808 Cymbal		Timpani C#
50	High Tom 1	Room Hi Tom 1	Room Hi Tom 1	Elec Hi Tom 1	808 Hi Tom 1		Timpani D
51	Ride Cymbal 1						Timpani D#
52	Chinese Cymbal			Reverse Cymbal			Timpani E
53	Ride Bell						Timpani F
54	Tambourine						
55	Splash Cymbal						
56	Cowbell				808 Cowbell		
57	Crash Cymbal 2						Concert Cymbal 2
58	Vibra - slap						
59	Ride Cymbal 2						Concert Cymbal 1
60	High Bongo						
61	Low Bongo						
62	Mute High Conga				808 High Conga		
63	Open High Conga				808 Mid Conga		
64	Low Conga				808 Low Conga		
65	High Timbale						
66	Low Timbale						
67	High Agogo						
68	Low Agogo						
69	Cabasa						
70	Maracas				808 Maracas		
71	Short Hi Whistle [EXC2]						
72	Long Low Whistle [EXC2]						
73	Short Guiro [EXC3]						
74	Long Guiro [EXC3]						
75	Claves				808 Claves		
76	High Wood Block						
77	Low Wood Block						
78	Mute Cuica [EXC4]						
79	Open Cuica [EXC4]						
80	Mute Triangle [EXC5]						
81	Open Triangle [EXC5]						
82	Shaker						
83	Jingle Bell						
84	Belltree						
85	Castanets						
86	Mute Surdo [EXC6]						
87	Open Surdo [EXC6]						
88							Applause

Blank : Same as the percussion sound of "Standard"
 - - - - : No sound
 [EXC] : Percussion sound of the same number will not be heard at the same time.

● SFX set (Program number 57)

● CM-64/32L set (Program number 128)

Note number	57:SFX Set
39	High Q
40	Slap
41	Scratch Push
42	Scratch Pull
43	Sticks
44	Square Click
45	Metronome Click
46	Metronome Bell
47	Guitar sliding finger
48	Guitar cutting noise (down)
49	Guitar cutting noise (up)
50	String slap of double bass
51	Key Click
52	Laughing
53	Screaming
54	Punch
55	Heart Beat
56	Footsteps1
57	Footsteps2
58	Applause
59	Door Creaking
60	Door
61	Scratch
62	Windchime
63	Car-Engine
64	Car-Stop
65	Car-Pass
66	Car-Crash
67	Siren
68	Train
69	Jetplane
70	Helicopter
71	Starship
72	Gun Shot
73	Machinegun
74	Lasergun
75	Explosion
76	Dog
77	Horse-Gallop
78	Birds
79	Rain
80	Thunder
81	Wind
82	Sea Shore
83	Stream
84	Bubble

----- : No sound

[EXC] : Percussion sounds of the same number cannot be heard at the same time.

* The CM-64/32L set is the MT-32 drum set with SFX sounds added to it.

Note number	128:CM-64/32L Set
34	-----
35	Acoustic Bass Drum
36	Acoustic Bass Drum
37	Rim Shot
38	Acoustic Snare Drum
39	Hand Clap
40	Electronic Snare Drum
41	Acoustic Low Tom
42	Closed High Hat [EXC1]
43	Acoustic Low Tom
44	Open High Hat 2
45	Acoustic Middle Tom
46	Open High Hat 1 [EXC1]
47	Acoustic Middle Tom
48	Acoustic High Tom
49	Crash Cymbal
50	Acoustic High Tom
51	Ride Cymbal
52	-----
53	-----
54	Tambourine
55	-----
56	Cowbell
57	-----
58	-----
59	-----
60	High Bongo
61	Low Bongo
62	Mute High Conga
63	High Conga
64	Low Conga
65	High Timbale
66	Low Timbale
67	High Agogo
68	Low Agogo
69	Cabasa
70	Maracas
71	Short Whistle
72	Long Whistle
73	Oujada
74	-----
75	Claves
76	Laughing
77	Screaming
78	Punch
79	Heartbeat
80	Footsteps 1
81	Footsteps 2
82	Applause
83	Creaking
84	Door
85	Scratch
86	Windchime
87	Engine
88	Car-stop
89	Car-pass
90	Crash
91	Siren
92	Train
93	Jet
94	Helicopter
95	Starship
96	Pistol
97	Machinegun
98	Lasergun
99	Explosion
100	Dog
101	Horse
102	Birds
103	Rain
104	Thunder
105	Wind
106	Waves
107	Stream
108	Bubble

Roland Exclusive Messages

1. Data Format for Exclusive Messages

Roland's MIDI implementation uses the following data format for all exclusive messages (type IV):

Byte	Description
F0H	Exclusive status
41H	Manufacturer ID (Roland)
DEV	Device ID
MDL	Model ID
CMD	Command ID
[BODY]	Main data
F7H	End of exclusive

MIDI status : F0H, F7H

An exclusive message must be flanked by a pair of status codes, starting with a Manufacturer-ID immediately after F0H (MIDI version1.0).

Manufacturer-ID : 41H

The Manufacturer-ID identifies the manufacturer of a MIDI instrument that triggers an exclusive message. Value 41H represents Roland's Manufacturer-ID.

Device-ID : DEV

The Device-ID contains a unique value that identifies the individual device in the multiple implementation of MIDI instruments. It is usually set to 00H - 0FH, a value smaller by one than that of a basic channel, but value 00H - 1FH may be used for a device with multiple basic channels.

Model-ID : MDL

The Model-ID contains a value that uniquely identifies one model from another. Different models, however, may share an identical Model-ID if they handle similar data.

The Model-ID format may contain 00H in one or more places to provide an extended data field. The following are examples of valid Model-IDs, each representing a unique model:

- 01H
- 02H
- 03H
- 00H, 01H
- 00H, 02H
- 00H, 00H, 01H

Command-ID : CMD

The Command-ID indicates the function of an exclusive message. The Command-ID format may contain 00H in one or more places to provide an extended data field. The following are examples of valid Command-IDs, each representing a unique function:

- 01H
- 02H
- 03H
- 00H, 01H
- 00H, 02H
- 00H, 00H, 01H

Main data : BODY

This field contains a message to be exchanged across an interface. The exact data size and contents will vary with the Model-ID and Command-ID.

2. Address-mapped Data Transfer

Address mapping is a technique for transferring messages conforming to the data format given in Section 1. It assigns a series of memory-resident records-waveform and tone data, switch status, and parameters, for example-to specific locations in a machine-dependent address space, thereby allowing access to data residing at the address a message specifies.

Address-mapped data transfer is therefore independent of models and data categories. This technique allows use of two different transfer procedures: one-way transfer and handshake transfer.

One-way transfer procedure (See Section 3 for details.)

This procedure is suited for the transfer of a small amount of data. It sends out an exclusive message completely independent of a receiving device status.

Connection Diagram

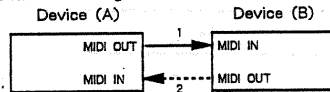

Connection at point 2 is essential for "Request data" procedures. (See Section 3.)

Handshake-transfer procedure (This device does not cover this procedure)

This procedure initiates a predetermined transfer sequence (handshaking) across the interface before data transfer takes place. Handshaking ensures that reliability and transfer speed are high enough to handle a large amount of data.

Connection Diagram

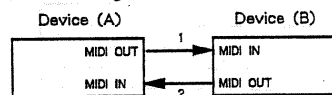

Connection at points 1 and 2 is essential.

Notes on the above two procedures

- * There are separate Command-IDs for different transfer procedures.
- * Devices A and B cannot exchange data unless they use the same transfer procedure, share identical Device-ID and Model ID, and are ready for communication.

3. One-way Transfer Procedure

This procedure sends out data all the way until it stops and is used when the messages are so short that answerbacks need not be checked. For long messages, however, the receiving device must acquire each message in time with the transfer sequence, which inserts intervals of at least 20 milliseconds in between.

Types of Messages

Message	Command ID
Request data 1	RQ1 (11H)
Data set 1	DT1 (12H)

Request data # 1 : RQ1 (11H)

This message is sent out when there is a need to acquire data from a device at the other end of the interface. It contains data for the address and size that specify designation and length, respectively, of data required.

On receiving an RQ1 message, the remote device checks its memory for the data address and size that satisfy the request.

If it finds them and is ready for communication, the device will transmit a "Data set 1 (DT1)" message, which contains the requested data. Otherwise, the device will send out nothing.

Byte	Description
F0H	Exclusive status
41H	Manufacturer ID (Roland)
DEV	Device ID
MDL	Model ID
11H	Command ID
aaH	Address MSB
⋮	⋮
⋮	LSB
ssH	Size MSB
⋮	⋮
⋮	LSB
sum	Check sum
F7H	End of exclusive

- *The size of the requested data does not indicate the number of bytes that will make up a DT1 message, but represents the address fields where the requested data resides.
- *Some models are subject to limitations in data format used for a single transaction. Requested data, for example, may have a limit in length or must be divided into predetermined address fields before it is exchanged across the interface.
- *The same number of bytes comprises address and size data, which, however, vary with the Model-ID.
- *The error checking process uses a checksum that provides a bit pattern where the least significant 7 bits are zero when values for an address, size, and that checksum are summed.

Data set 1: DT1 (12H)

This message corresponds to the actual data transfer process. Because every byte in the data is assigned a unique address, a DT1 message can convey the starting address of one or more data as well as a series of data formatted in an address-dependent order.

The MIDI standards inhibit non-real time messages from interrupting an exclusive one. This fact is inconvenient for the devices that support a "soft-through" mechanism. To maintain compatibility with such devices, Roland has limited the DT1 to 256 bytes so that an excessively long message is sent out in separate segments.

Byte	Description
FOH	Exclusive
41H	Manufacturer ID (Roland)
DEV	Device ID
MDL	Model ID
12H	Command ID
aaH	Address MSB
⋮	⋮
	LSB
ddH	Data
⋮	⋮
sum	Check sum
F7H	End of exclusive

- *A DT1 message is capable of providing only the valid data among those specified by an RQ1 message.
- *Some models are subject to limitations in data format used for a single transaction. Requested data, for example, may have a limit in length or must be divided into predetermined address fields before it is exchanged across the interface.
- *The number of bytes comprising address data varies from one Model-ID to another.
- *The error checking process uses a checksum that provides a bit pattern where the least significant 7 bits are zero when values for an address, size, and that checksum are summed.

Example of Message Transactions

- Device A sending data to Device B
Transfer of a DT1 message is all that takes place.

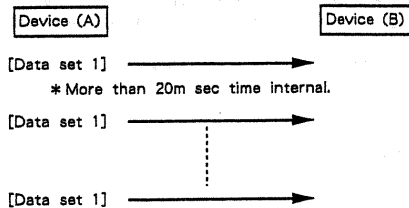

- Device B requesting data from Device A
Device B sends an RQ1 message to Device A. Checking the message, Device A sends a DT1 message back to Device B.

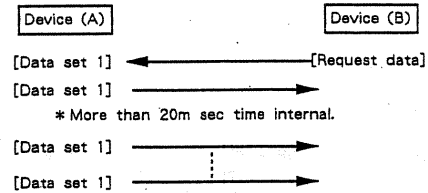

1. Receive data**■ Channel Voice Message****● Note off**

Status	Second	Third
8nH	kkH	vvH
9nH	kkH	00H

n = MIDI channel number : 0H - FH (0 - 15) 0 = ch.1 15 = ch.16
 kk = Note number : 00H - 7FH (0 - 127)
 vv = Velocity : 00H - 7FH (0 - 127)

*Recognized when "Rx.Note message = ON".
 *In drums part, recognized when "Rx.Note off = ON" at each instrument.
 *Velocity is ignored.

● Note on

Status	Second	Third
9nH	kkH	vvH

n = MIDI channel number : 0H - FH (0 - 15) 0 = ch.1 15 = ch.16
 kk = Note number : 00H - 7FH (0 - 127)
 vv = Velocity : 01H - 7FH (1 - 127)

*Recognized when "Rx.Note message = ON".
 *In drums part, recognized when "Rx.Note on = ON" at each instrument.

● Polyphonic key pressure

Status	Second	Third
AnH	kkH	vvH

n = MIDI channel number : 0H - FH (0 - 15) 0 = ch.1 15 = ch.16
 kk = Note number : 00H - 7FH (0 - 127)
 vv = Value : 00H - 7FH (0 - 127)

*Recognized when "Rx.Polyphonic key pressure = ON" and set on "PAf controller function".

● Control change

*Recognized when "Rx.Control change = ON" and set on "controller function".

○ Bank select

Status	Second	Third
BnH	00H	mmH
BnH	20H	llH

n = MIDI channel number : 0H - FH (0 - 15) 0 = ch.1 15 = ch.16
 mm, ll = Bank number : 00H, 00H - 7FH, 7FH (1 - 16384)

*The LSB 7-bit is ignored (value = 00).
 *"Bank select" is suspended until receiving "Program change".

○ Modulation

Status	Second	Third
BnH	01H	vvH

n = MIDI channel number : 0H - FH (0 - 15) 0 = ch.1 15 = ch.16
 vv = Modulation depth : 00H - 7FH (0 - 127)

*Recognized when "Rx.Modulation = ON (default setting)" and set on "controller function (default setting is pitch modulation)".

○ Portamento time

Status	Second	Third
BnH	05H	vvH

n = MIDI channel number : 0H - FH (0 - 15) 0 = ch.1 15 = ch.16
 vv = Portamento time : 00H - 7FH (0 - 127)

○ Data entry

Status	Second	Third
BnH	06H	mmH
BnH	26H	llH

n = MIDI channel number : 0H - FH (0 - 15) 0 = ch.1 15 = ch.16
 mm, ll = Value of the parameter specified with RPN and/or NRPN

○ Volume

Status	Second	Third
BnH	07H	vvH

n = MIDI channel number : 0H - FH (0 - 15) 0 = ch.1 15 = ch.16
 vv = Volume : 00H - 7FH (0 - 127)

*You can adjust the volume of specified channel (part).
 *Recognized when "Rx.Volume = ON (default setting)".

○ Panpot

Status	Second	Third
BnH	0AH	vvH

n = MIDI channel number : 0H - FH (0 - 15) 0 = ch.1 15 = ch.16
 vv = Panpot : 00H - 40H - 7FH (Left - Center - Right)

*Resolution of panpot is approx. 7-bit (127 steps).
 *Recognized when "Rx.Panpot = ON (default setting)".

○ Expression

Status	Second	Third
BnH	0BH	vvH

n = MIDI channel number : 0H - FH (0 - 15) 0 = ch.1 15 = ch.16
 vv = Expression : 00H - 7FH (0 - 127)

*You can adjust the volume of specified channel (part).
 *Recognized when "Rx.Expression = ON (default setting)".

○ Hold1

Status	Second	Third
BnH	40H	vvH

n = MIDI channel number : 0H - FH (0 - 15) 0 = ch.1 15 = ch.16
 vv = Control Value : 00H - 7FH (0 - 127) 0 - 63 = OFF, 64 - 127 = ON

*Recognized when "Rx.Hold1 = ON (default setting)".

○ Portamento

Status	Second	Third
BnH	41H	vvH

n = MIDI channel number : 0H - FH (0 - 15) 0 = ch.1 15 = ch.16
 vv = Control Value : 00H - 7FH (0 - 127) 0 - 63 = OFF, 64 - 127 = ON

*Recognized when "Rx.Portamento = ON (default setting)".

○ Sostenuto

Status	Second	Third
BnH	42H	vvH

n = MIDI channel number : 0H - FH (0 - 15) 0 = ch.1 15 = ch.16
 vv = Control Value : 00H - 7FH (0 - 127) 0 - 63 = OFF, 64 - 127 = ON

*Recognized when "Rx.Sostenuto = ON (default setting)".

○ Soft

Status	Second	Third
BnH	43H	vvH

n = MIDI channel number : 0H - FH (0 - 15) 0 = ch.1 15 = ch.16
 vv = Control Value : 00H - 7FH (0 - 127) 0 - 63 = OFF, 64 - 127 = ON

*Recognized when "Rx.Soft = ON (default setting)".

○Effect1 depth (Reverb send level)

<u>Status</u>	<u>Second</u>	<u>Third</u>
BnH	5BH	vvH

n = MIDI channel number : 0H - FH (0 - 15) 0 = ch.1 15 = ch.16
 vv = Reverb send depth : 00H - 7FH (0 - 127)

○Effect3 depth (Chorus send level)

<u>Status</u>	<u>Second</u>	<u>Third</u>
BnH	5DH	vvH

n = MIDI channel number : 0H - FH (0 - 15) 0 = ch.1 15 = ch.16
 vv = Chorus send depth : 00H - 7FH (0 - 127)

○NRPN MSB/LSB

<u>Status</u>	<u>Second</u>	<u>Third</u>
BnH	63H	mmH
BnH	62H	llH

n = MIDI channel number : 0H - FH (0 - 15) 0 = ch.1 15 = ch.16
 mm = MSB of the specified parameter by NRPN
 ll = LSB of the specified parameter by NRPN

*Recognized when "Rx.NRPN = ON (default setting)".

** NRPN **

NRPN (Non Registered Parameter Number) is an expanded control change message.

Each function of NRPN is described by individual manufacture.

You can change the value of several SC-55 parameters. Set first NRPN MSB/LSB before sending data entry.

SC-55 can receive parameters as shown below ;

NRPN	Data entry	Description
MSB LSB	MSB	
01H 08H	mmH	Vibrate rate relative change on specified channel mm: 0EH-40H-72H (-50 - 0 - +50)
01H 09H	mmH	Vibrate depth relative change on specified channel mm: 0EH-40H-72H (-50 - 0 - +50)
01H 0AH	mmH	Vibrate delay relative change on specified channel mm: 0EH-40H-72H (-50 - 0 - +50)
01H 20H	mmH	TVF cutoff frequency relative change on specified channel mm: 0EH-40H-72H (-50 - 0 - +50)
01H 21H	mmH	TVF resonance relative change on specified channel mm: 0EH-40H-72H (-50 - 0 - +50)
01H 63H	mmH	TVF&TVA Env. Attack time relative change on specified channel mm: 0EH-40H-72H (-50 - 0 - +50)
01H 64H	mmH	TVF&TVA Env. Decay time relative change on specified channel mm: 0EH-40H-72H (-50 - 0 - +50)
01H 66H	mmH	TVF&TVA Env. Release time relative change on specified channel mm: 0EH-40H-72H (-50 - 0 - +50)
18H rrH	mmH	Pitch coarse of drum instrument relative change on specified drum instrument rr: key number of drum instrument mm: 00H-40H-7FH (-64 - 0 - +63 semitone)
1AH rrH	mmH	TVA level of drum instrument absolute change on specified drum instrument rr: key number of drum instrument mm: 00H-7FH (zero - maximum)

1CH rrH mmH Panpot of drum instrument
 absolute change on specified drum instrument
 rr: key number of drum instrument
 mm: 00H,01H-40H-7FH (Random, Left-Center-Right)

1DH rrH mmH Reverb send level of drum instrument
 absolute change on specified drum instrument
 rr: key number of drum instrument
 mm: 00H-7FH (zero - maximum)

*Data entry LSB is ignored.

○RPN MSB/LSB

<u>Status</u>	<u>Second</u>	<u>Third</u>
BnH	65H	mmH
BnH	64H	llH

n = MIDI channel number : 0H - FH (0 - 15) 0 = ch.1 15 = ch.16
 mm = MSB of the specified parameter by RPN
 ll = MSB of the specified parameter by RPN

*Recognized when "Rx.RPN = ON (default setting)".

** RPN **

RPN (Registered Parameter Number) is the expanded contro change message. Each function of RPN is described by MIDI.

You can change the value of RPN parameters. First, set RPN MSB/LSB before sending data entry.

SC-55 can receive Pitch bend sensitivity (RPN # 0), Master fine tuning (RPN # 1), Master coarse tuning (RPN # 2) and RPN reset (RPN # 16383).

RPN	Data entry	Description
MSB LSB	MSB LSB	
00H 00H	mmH ---	Pitch bend sensitivity mm: 00H-18H (0 - 24 semitone) ll: ignored (Up to 2 octaves, power on default is two semitones)
00H 01H	mmH llH	Master fine tuning mm, ll: 00H,00H-40H,00H-7FH,7FH (-8192*100/8192 - 0 - +8191*100/8192 .cent)
00H 02H	mmH ---	Master coarse tuning mm: 28H-40H-58H (-24 - 0 - +24 semitone) ll: ignored
7FH 7FH	--- ---	RPN reset Return to no specified parameter of RPN and NRPN. Current setting value is no change. mm, ll: ignored

● Program change

<u>Status</u>	<u>Second</u>
CnH	ppH

n = MIDI channel number : 0H - FH (0 - 15) 0 = ch.1 15 = ch.16
 pp = Program number : 00H - 7FH (0 - 127)

*Recognized when "Rx.Program change = ON (default setting)".

● Channel pressure

<u>Status</u>	<u>Second</u>
DnH	vvH

n = MIDI channel number : 0H - FH (0 - 15) 0 = ch.1 15 = ch.16
 vv = Value : 00H - 7FH (0 - 127)

*Recognized when "Rx.Channel pressure = ON" and set on "controller function".

● Pitch bend change

Status	Second	Third
BnH	11H	mmH

n = MIDI channel number : 0H - FH (0 - 15) 0 = ch.1 15 = ch.16
 mm,11 = Value : 00H,00H - 40H,00H - 7FH,7FH (- 8192 - 0 - + 8191)

*Recognized when "Rx.Pitch bend change = ON (default setting)" and set on "controller function (default setting is pitch bend)".

■ Channel Mode Message

● All sounds off

Status	Second	Third
BnH	78H	00H

n = MIDI channel number : 0H - FH (0 - 15) 0 = ch.1 15 = ch.16

*When "All sounds off" is received, all sounds on specified channel turn off immediately. However, the condition of channel message: Note on, Hold 1 on and so on maintain.

● Reset all controllers

Status	Second	Third
BnH	79H	00H

n = MIDI channel number : 0H - FH (0 - 15) 0 = ch.1 15 = ch.16

*When "reset all controllers" is received, controller value of specified channel return to power on default.

Controller	Value
Pitch bend change	± 0 (Center)
Polyphonic key pressure	0 (off)
Channel pressure	0 (off)
Modulation	0 (off)
Expression	127 (maximum)
Hold1	0 (off)
Portamento	0 (off)
Sostenuto	0 (off)
Soft	0 (off)
RPN	No specified parameter, value is no change.
NRPN	No specified parameter, value is no change.

● All notes off

Status	Second	Third
BnH	7BH	00H

n = MIDI channel number : 0H - FH (0 - 15) 0 = ch.1 15 = ch.16

*When "All notes off" is received, all on state notes turn to off in the specified channel. However, sound remains when hold1 and/or sostenuto is on.

● OMNI OFF

Status	Second	Third
BnH	7CH	00H

n = MIDI channel number : 0H - FH (0 - 15) 0 = ch.1 15 = ch.16

*OMNI OFF is only recognized as "all notes off". Mode doesn't change.

● OMNI ON

Status	Second	Third
BnH	7DH	00H

n = MIDI channel number : 0H - FH (0 - 15) 0 = ch.1 15 = ch.16

*OMNI ON is only recognized as "all notes off". Mode doesn't change, still OMNI OFF.

● MONO

Status	Second	Third
BnH	7EH	mmH

n = MIDI channel number : 0H - FH (0 - 15) 0 = ch.1 15 = ch.16
 mm = number of mono : 00H - 10H (0 - 16)

*MONO is recognized as "all notes off". And the specified channel turns to Mode4 (m = 1), even if mm is not equal to 1 (mm is ignored).

● POLY

Status	Second	Third
BnH	7FH	00H

n = MIDI channel number : 0H - FH (0 - 15) 0 = ch.1 15 = ch.16

*POLY is recognized as "all notes off". And the specified channel turns to Mode3.

■ System Realtime Message

● Active sensing

Status
FEH

*Having received "active sensing", SC - 55 expects the interval of any data to occur within 300 ms. If the interval is over 420 milli-second, SC - 55 does "All sounds off", "All notes off" and "Reset all controllers" and returns to normal operation.(will not check interval time)

■ System Exclusive Message

Status	Data
FOH	iiH,ddH,.....,eeH
F7H	

FOH : System exclusive
 ii = ID number : 41H (65)
 dd,....,ee = data : 00H - 7FH (0 - 127)
 F7H : EOX (End of Exclusive/System common)

*Refer to section 3, 4.

2. Transmit data

■ System Realtime Message

● Active sensing

Status
FEH

* Transmit at about 250 milli-second interval.

■ System Exclusive Message

Status	Data
FOH	iiH,ddH,.....,eeH
F7H	

FOH : System exclusive
 ii = ID number : 41H (65)
 dd,....,ee = data : 00H - 7FH (0 - 127)
 F7H : EOX (End of Exclusive/System common)

*Refer to section 3, 4.

3. Exclusive communications

SC-55 can transmit and receive the patch parameters using system exclusive message.

Model ID of SC-55 is 42H (GSstandard) and 45H (SC-55).
Device ID is 00H - 1FH.

One way communication

Request data 1 RQ1 (11H)

Byte	Description
F0H	Exclusive status
41H	Manufacturer's ID (Roland)
dev	Device ID (dev: 00H - 1FH)
mdl	Model ID (GSstandard)
11H	Command ID (RQ1)
aaH	Address MSB
bbH	:
ccH	Address LSB
ssH	Size MSB
ttH	:
uuH	Size LSB
sum	Check sum
F7H	EOX (End of exclusive)

Data set 1 DT1 (12H)

Byte	Description
F0H	Exclusive status
41H	Manufacturer's ID (Roland)
dev	Device ID (dev: 00H - 1FH)
mdl	Model ID (GSstandard)
12H	Command ID (DT1)
aaH	Address MSB
bbH	Address
ccH	Address LSB
ddH	Data
:	:
ddH	Data
sum	Check sum
F7H	EOX (End of exclusive)

4. Parameter address map (Model ID = 42H)

The address and size are described with 7-bit hexadecimal.

Address	MSB	LSB
Binary	0aaa aaaa	0bbb bbbb 0ccc cccc
Hexadecimal	AA	BB CC
Size	MSB	LSB
Binary	0sss ssss	0ttt tttt 0uuu uuuu
Hexadecimal	SS	TT UU

Parameter base address

There are two types of the SC-55 exclusive message. One is an individual parameter communication, another is a bulk dump communication.

Coarse address map of the exclusive communication is shown below:

< Model ID = 45H >

Address	Block	Sub Block	Notes
10 00 00	Display data		Individual (DT1 only)

< Model ID = 42H >

Address	Block	Sub Block	Notes
40 00 00	System parameters		Individual
40 01 00	Patch parameters	Patch common	Individual
		Patch block 0	
		Patch block F	
40 30 00	Information		Individual
41 00 00	Drum setup parameters	Drum map name	Individual
		Drum inst parameters	
48 00 00	Bulk dump (Patch parameters)	Patch common	Bulk
		Patch block 0	
		Patch block F	
49 00 00	Bulk dump (Drum setup parameters)	Drum inst parameters	Bulk
		Drum map name	

Notes: Using address of individual parameters

One system exclusive message "FO F7" can only have one parameter. You cannot use any address having " #" for the top address in a system exclusive message.

<MODEL ID = 45H>

[DISPLAY DATA]

Address(H)	SIZE(H)	Data(H)	Parameter	Description	Default Value (H)
10 00 00	00 00 20	20 - 7F	DISPLAYED LETTER	32 - 127 (ASCII)	20
10 00 01#					
10 00 02#					
10 00 :					
10 00 1F#					

Data size is recognized through 1 - 32 bytes.
When data size is more than 17 bytes, the display scroll automatically.

Address(H)	SIZE(H)	Data(H)	Parameter	Description	Default Value (H)
10 01 00	00 00 40	00 - 1F	DISPLAYED DOT DATA	d00 00 - 31	00
10 00 01#				d01	
10 00 02#				d02	
10 00 :					
10 00 3F#				d63	

The relation of the data and dot is as follows:
When bit# is 0, the dot is turned off.
When bit# is 1, the dot is turned on.

bit#	0	1	2	3	4	5	6	7	8	9	10	11	12	13	14	15
bit#	4	3	2	1	0	4	3	2	1	0	4	3	2	1	0	4
0	[d00 ***]	[d01 ***]	[d02 ***]	[d03 ***]	[d04 ***]	[d05 ***]	[d06 ***]	[d07 ***]	[d08 ***]	[d09 ***]	[d10 ***]	[d11 ***]	[d12 ***]	[d13 ***]	[d14 ***]	[d15 ***]
1	[d16 ***]	[d17 ***]	[d18 ***]	[d19 ***]	[d20 ***]	[d21 ***]	[d22 ***]	[d23 ***]	[d24 ***]	[d25 ***]	[d26 ***]	[d27 ***]	[d28 ***]	[d29 ***]	[d30 ***]	[d31 ***]
2	[d32 ***]	[d33 ***]	[d34 ***]	[d35 ***]	[d36 ***]	[d37 ***]	[d38 ***]	[d39 ***]	[d40 ***]	[d41 ***]	[d42 ***]	[d43 ***]	[d44 ***]	[d45 ***]	[d46 ***]	[d47 ***]
3	[d48 ***]	[d49 ***]	[d50 ***]	[d51 ***]	[d52 ***]	[d53 ***]	[d54 ***]	[d55 ***]	[d56 ***]	[d57 ***]	[d58 ***]	[d59 ***]	[d60 ***]	[d61 ***]	[d62 ***]	[d63 ***]

<MODEL ID = 42H>

[SYSTEM PARAMETERS]

Address(H)	SIZE(H)	Data(H)	Parameter	Description	Default Value (H)
40 00 00	00 00 04	0018 - 07E8	MASTER TUNE	-100.0 - +100.0 [cent]	00 04 00 00
40 00 01#				Use nibblized data.	
40 00 02#					
40 00 03#					
40 00 04	00 00 01	00 - 7F	MASTER VOLUME	0 - 127	7F
40 00 05	00 00 01	28 - 58	MASTER KEY-SHIFT	-24 - +24 semitones	40
40 00 06	00 00 01	01 - 7F	MASTER PAN		40
40 00 7F	00 00 01	00	RESET TO THE GSstandard MODE	System reset and set all internal parameters to the default setting.	

For example:

If you set +100.0 cent for master tune, you must send the message as follow.
F0 41 10 42 12 40 00 00 00 07 0E 08 sum F7

If you set 100(decimal) for master volume, you must send the message as follow.
F0 41 10 42 12 40 00 04 64 sum F7

[PATCH PARAMETERS]

*n...block number (0 - F), Part 1 (default MIDIch = 1) n = 1.
 : :
 Part 9 (default MIDIch = 9) n = 9
 Part10 (default MIDIch = 10) n = 0
 Part11 (default MIDIch = 11) n = A
 : :
 Part16 (default MIDIch = 16) n = F

*x...MIDI channel number (0 - F).

Address (H)	SIZE (H)	Data (H)	Parameter	Description	Default Value (H)
40 01 00	00 00 10	20 - 7F	PATCH NAME	16 ASCII Characters	
40 01 0F#					
40 01 10	00 00 10	00 - 18	PARTIAL RESERVE	Part 10(Block 0: Drums)	02
40 01 11#				Part 1 (Block 1)	06
40 01 12#				Part 2 (Block 2)	02
40 01 13#				Part 3 (Block 3)	02
40 01 14#				Part 4 (Block 4)	02
40 01 15#				Part 5 (Block 5)	02
40 01 16#				Part 6 (Block 6)	02
40 01 17#				Part 7 (Block 7)	02
40 01 18#				Part 8 (Block 8)	02
40 01 19#				Part 9 (Block 9)	02
40 01 1A#				Part 11(Block A)	00
40 01 :#				:	
40 01 1F#				Part 16(Block F)	00
The sum of partial reserves must be less than or equal to 24. For example, 17H is the maximum value for 24 voice sound generator.					
40 01 30	00 00 01	00 - 07	REVERB MACRO	00: Room 1 01: Room 2 02: Room 3 03: Hall 1 04: Hall 2 05: Plate 06: Delay 07: Panning Delay	04
40 01 31	00 00 01	00 - 07	REVERB CHARACTER		04
40 01 32	00 00 01	00 - 07	REVERB PRE-LPF		00
40 01 33	00 00 01	00 - 7F	REVERB LEVEL		40
40 01 34	00 00 01	00 - 7F	REVERB TIME		40
40 01 35	00 00 01	00 - 7F	REVERB DELAY FEEDBACK		00
40 01 36	00 00 01	00 - 7F	REVERB SEND LEVEL TO CHORUS		00
40 01 38	00 00 01	00 - 07	CHORUS MACRO	00: Chorus 1 01: Chorus 2 02: Chorus 3 03: Chorus 4 04: Feedback Chorus 05: Flanger 06: Short Delay 07: Short Delay(FB)	02
40 01 39	00 00 01	00 - 07	CHORUS PRE-LPF		00
40 01 3A	00 00 01	00 - 7F	CHORUS LEVEL		40
40 01 3B	00 00 01	00 - 7F	CHORUS FEEDBACK		08
40 01 3C	00 00 01	00 - 7F	CHORUS DELAY		50
40 01 3D	00 00 01	00 - 7F	CHORUS RATE		03
40 01 3E	00 00 01	00 - 7F	CHORUS DEPTH		13
40 01 3F	00 00 01	00 - 7F	CHORUS SEND LEVEL TO REVERB		00
40 1n 00	00 00 02	00 - 7F	TONE NUMBER	CC#00 VALUE	00
40 1n 01#		00 - 7F		P.C. VALUE	00
40 1n 02	00 00 01	00 - 10	Rx. CHANNEL	1 - 16, OFF	same as the Part#
40 1n 03	00 00 01	00 - 01	Rx. PITCH BEND	OFF / ON	01
40 1n 04	00 00 01	00 - 01	Rx. CH PRESSURE (CAF)	OFF / ON	01
40 1n 05	00 00 01	00 - 01	Rx. PROGRAM CHANGE	OFF / ON	01
40 1n 06	00 00 01	00 - 01	Rx. CONTROL CHANGE	OFF / ON	01
40 1n 07	00 00 01	00 - 01	Rx. POLY PRESSURE (PAT)	OFF / ON	01
40 1n 08	00 00 01	00 - 01	Rx. NOTE MESSAGE	OFF / ON	01
40 1n 09	00 00 01	00 - 01	Rx. RPN	OFF / ON	01
40 1n 0A	00 00 01	00 - 01	Rx. NRPN	OFF / ON	01
40 1n 0B	00 00 01	00 - 01	Rx. MODURATION	OFF / ON	01
40 1n 0C	00 00 01	00 - 01	Rx. VOLUME	OFF / ON	01
40 1n 0D	00 00 01	00 - 01	Rx. PANPOT	OFF / ON	01
40 1n 0E	00 00 01	00 - 01	Rx. EXPRESSION	OFF / ON	01
40 1n 0F	00 00 01	00 - 01	Rx. HOLD1	OFF / ON	01
40 1n 10	00 00 01	00 - 01	Rx. PORTAMENTO	OFF / ON	01

40	ln	11	00 00 01	00 - 01	Rx. SOSTENUTO	OFF / ON	01
40	ln	12	00 00 01	00 - 01	Rx. SOFT	OFF / ON	01
40	ln	13	00 00 01	00 - 01	MONO/POLY MODE	Mono / Poly (=Bx 7E-01 / Bx 7F 00)	01
40	ln	14	00 00 01	00 - 02	ASSIGN MODE	0 = SINGLE 1 = LIMITED-MULTI 2 = FULL-MULTI	00 at n=0 01 at n!=0
40	ln	15	00 00 01	00 - 02	USE FOR RHYTHM PART	0 = OFF 1 = MAP1 2 = MAP2	00 at n!=0 01 at n=0
40	ln	16	00 00 01	28 - 58	PITCH KEY SHIFT	-24 - +24 [semitone]	40
40	ln	17	00 00 02	08 - F8	PITCH OFFSET FINE	-12.0 - +12.0 [Hz]	08 00
40	ln	18#				Use nibblized data.	
40	ln	19	00 00 01	00 - 7F	PART LEVEL	0 - 127 (=Bx 07 vv)	64
40	ln	1A	00 00 01	00 - 7F	VELOCITY SENSE DEPTH	0 - 127	40
40	ln	1B	00 00 01	00 - 7F	VELOCITY SENSE OFFSET	0 - 127	40
40	ln	1C	00 00 01	00 - 7F	PART PANPOT	Random, -63 (LEFT) - +63 (RIGHT) (=Bx 0A vv, except random)	40
40	ln	1D	00 00 01	00 - 7F	KEY RANGE LOW	C-1 - G9	00
40	ln	1E	00 00 01	00 - 7F	KEY RANGE HIGH	C-1 - G9	7F
40	ln	1F	00 00 01	00 - 7F	CC1 CONTROLLER NUMBER	0 - 127	10
40	ln	20	00 00 01	00 - 7F	CC2 CONTROLLER NUMBER	0 - 127	11
40	ln	21	00 00 01	00 - 7F	CHORUS SEND DEPTH	0 - 127 (=Bx 5D vv)	00
40	ln	22	00 00 01	00 - 7F	REVERB SEND DEPTH	0 - 12 (=Bx 5B vv)	28
40	ln	30	00 00 01	0E - 72	TONE MODIFY 1	-50 - +50	40
					Vibrato rate	(=Bx 63 01 62 08 06 vv)	
40	ln	31	00 00 01	0E - 72	TONE MODIFY 2	-50 - +50	40
					Vibrato depth	(=Bx 63 01 62 09 06 vv)	
40	ln	32	00 00 01	0E - 72	TONE MODIFY 3	-50 - +50	40
					TVF cutoff freq.	(=Bx 63 01 62 20 06 vv)	
40	ln	33	00 00 01	0E - 72	TONE MODIFY 4	-50 - +50	40
					TVF resonance	(=Bx 63 01 62 21 06 vv)	
40	ln	34	00 00 01	0E - 72	TONE MODIFY 5	-50 - +50	40
					TVF&TVA Env. attack	(=Bx 63 01 62 63 06 vv)	
40	ln	35	00 00 01	0E - 72	TONE MODIFY 6	-50 - +50	40
					TVF&TVA Env. decay	(=Bx 63 01 62 64 06 vv)	
40	ln	36	00 00 01	0E - 72	TONE MODIFY 7	-50 - +50	40
					TVF&TVA Env. release	(=Bx 63 01 62 66 06 vv)	
40	ln	37	00 00 01	0E - 72	TONE MODIFY 8	-50 - +50	40
					Vibrato delay	(=Bx 63 01 62 0A 06 vv)	
40	ln	40	00 00 0C	00 - 7F	SCALE TUNING C	-64 - +63 [cent]	40
40	ln	41#		00 - 7F	SCALE TUNING C#	-64 - +63 [cent]	40
40	ln	42#		00 - 7F	SCALE TUNING D	-64 - +63 [cent]	40
40	ln	43#		00 - 7F	SCALE TUNING D#	-64 - +63 [cent]	40
40	ln	44#		00 - 7F	SCALE TUNING E	-64 - +63 [cent]	40
40	ln	45#		00 - 7F	SCALE TUNING F	-64 - +63 [cent]	40
40	ln	46#		00 - 7F	SCALE TUNING F#	-64 - +63 [cent]	40
40	ln	47#		00 - 7F	SCALE TUNING G	-64 - +63 [cent]	40
40	ln	48#		00 - 7F	SCALE TUNING G#	-64 - +63 [cent]	40
40	ln	49#		00 - 7F	SCALE TUNING A	-64 - +63 [cent]	40
40	ln	4A#		00 - 7F	SCALE TUNING A#	-64 - +63 [cent]	40
40	ln	4B#		00 - 7F	SCALE TUNING B	-64 - +63 [cent]	40
40	2n	00	00 00 01	28 - 58	MOD PITCH CONTROL	-24 - +24 [semitone]	40
40	2n	01	00 00 01	00 - 7F	MOD TVF CUTOFF CONTROL	-9600 - +9600 [cent]	40
40	2n	02	00 00 01	00 - 7F	MOD AMPLITUDE CONTROL	-100.0 - +100.0 [%]	40
40	2n	03	00 00 01	00 - 7F	MOD LFO1 RATE CONTROL	-10.0 - +10.0 [Hz]	40
40	2n	04	00 00 01	00 - 7F	MOD LFO1 PITCH DEPTH	0 - 600 [cent]	0A
40	2n	05	00 00 01	00 - 7F	MOD LFO1 TVF DEPTH	0 - 2400 [cent]	00
40	2n	06	00 00 01	00 - 7F	MOD LFO1 TVA DEPTH	0 - 100.0 [%]	00
40	2n	07	00 00 01	00 - 7F	MOD LFO2 RATE CONTROL	-10.0 - +10.0 [Hz]	40
40	2n	08	00 00 01	00 - 7F	MOD LFO2 PITCH DEPTH	0 - 600 [cent]	00
40	2n	09	00 00 01	00 - 7F	MOD LFO2 TVF DEPTH	0 - 2400 [cent]	00
40	2n	0A	00 00 01	00 - 7F	MOD LFO2 TVA DEPTH	0 - 100.0 [%]	00
40	2n	10	00 00 01	40 - 58	BEND PITCH CONTROL	0 - 24 [semitone]	42
40	2n	11	00 00 01	00 - 7F	BEND TVF CUTOFF CONTROL	-9600 - +9600 [cent]	40
40	2n	12	00 00 01	00 - 7F	BEND AMPLITUDE CONTROL	-100.0 - +100.0 [%]	40
40	2n	13	00 00 01	00 - 7F	BEND LFO1 RATE CONTROL	-10.0 - +10.0 [Hz]	40

40 2n 14	00 00 01	00 - 7F	BEND LFO1 PITCH DEPTH	0 - 600 [cent]	00
40 2n 15	00 00 01	00 - 7F	BEND LFO1 TVF DEPTH	0 - 2400 [cent]	00
40 2n 16	00 00 01	00 - 7F	BEND LFO1 TVA DEPTH	0 - 100.0 [%]	00
40 2n 17	00 00 01	00 - 7F	BEND LFO2 RATE CONTROL	-10.0 - +10.0 [Hz]	40
40 2n 18	00 00 01	00 - 7F	BEND LFO2 PITCH DEPTH	0 - 600 [cent]	00
40 2n 19	00 00 01	00 - 7F	BEND LFO2 TVF DEPTH	0 - 2400 [cent]	00
40 2n 1A	00 00 01	00 - 7F	BEND LFO2 TVA DEPTH	0 - 100.0 [%]	40
40 2n 20	00 00 01	28 - 58	CAF PITCH CONTROL	-24 - +24 [semitone]	40
40 2n 21	00 00 01	00 - 7F	CAF TVF CUTOFF CONTROL	-9600 - +9600 [cent]	40
40 2n 22	00 00 01	00 - 7F	CAF AMPLITUDE CONTROL	-100.0 - +100.0 [%]	40
40 2n 23	00 00 01	00 - 7F	CAF LFO1 RATE CONTROL	-10.0 - +10.0 [Hz]	40
40 2n 24	00 00 01	00 - 7F	CAF LFO1 PITCH DEPTH	0 - 600 [cent]	00
40 2n 25	00 00 01	00 - 7F	CAF LFO1 TVF DEPTH	0 - 2400 [cent]	00
40 2n 26	00 00 01	00 - 7F	CAF LFO1 TVA DEPTH	0 - 100.0 [%]	00
40 2n 27	00 00 01	00 - 7F	CAF LFO2 RATE CONTROL	-10.0 - +10.0 [Hz]	40
40 2n 28	00 00 01	00 - 7F	CAF LFO2 PITCH DEPTH	0 - 600 [cent]	00
40 2n 29	00 00 01	00 - 7F	CAF LFO2 TVF DEPTH	0 - 2400 [cent]	00
40 2n 2A	00 00 01	00 - 7F	CAF LFO2 TVA DEPTH	0 - 100.0 [%]	00
40 2n 30	00 00 01	28 - 58	PAF PITCH CONTROL	-24 - +24 [semitone]	40
40 2n 31	00 00 01	00 - 7F	PAF TVF CUTOFF CONTROL	-9600 - +9600 [cent]	40
40 2n 32	00 00 01	00 - 7F	PAF AMPLITUDE CONTROL	-100.0 - +100.0 [%]	40
40 2n 33	00 00 01	00 - 7F	PAF LFO1 RATE CONTROL	-10.0 - +10.0 [Hz]	40
40 2n 34	00 00 01	00 - 7F	PAF LFO1 PITCH DEPTH	0 - 600 [cent]	00
40 2n 35	00 00 01	00 - 7F	PAF LFO1 TVF DEPTH	0 - 2400 [cent]	00
40 2n 36	00 00 01	00 - 7F	PAF LFO1 TVA DEPTH	0 - 100.0 [%]	00
40 2n 37	00 00 01	00 - 7F	PAF LFO2 RATE CONTROL	-10.0 - +10.0 [Hz]	40
40 2n 38	00 00 01	00 - 7F	PAF LFO2 PITCH DEPTH	0 - 600 [cent]	00
40 2n 39	00 00 01	00 - 7F	PAF LFO2 TVF DEPTH	0 - 2400 [cent]	00
40 2n 3A	00 00 01	00 - 7F	PAF LFO2 TVA DEPTH	0 - 100.0 [%]	00
40 2n 40	00 00 01	28 - 58	CC1 PITCH CONTROL	-24 - +24 [semitone]	40
40 2n 41	00 00 01	00 - 7F	CC1 TVF CUTOFF CONTROL	-9600 - +9600 [cent]	40
40 2n 42	00 00 01	00 - 7F	CC1 AMPLITUDE CONTROL	-100.0 - +100.0 [%]	40
40 2n 43	00 00 01	00 - 7F	CC1 LFO1 RATE CONTROL	-10.0 - +10.0 [Hz]	40
40 2n 44	00 00 01	00 - 7F	CC1 LFO1 PITCH DEPTH	0 - 600 [cent]	00
40 2n 45	00 00 01	00 - 7F	CC1 LFO1 TVF DEPTH	0 - 2400 [cent]	00
40 2n 46	00 00 01	00 - 7F	CC1 LFO1 TVA DEPTH	0 - 100.0 [%]	00
40 2n 47	00 00 01	00 - 7F	CC1 LFO2 RATE CONTROL	-10.0 - +10.0 [Hz]	40
40 2n 48	00 00 01	00 - 7F	CC1 LFO2 PITCH DEPTH	0 - 600 [cent]	00
40 2n 49	00 00 01	00 - 7F	CC1 LFO2 TVF DEPTH	0 - 2400 [cent]	00
40 2n 4A	00 00 01	00 - 7F	CC1 LFO2 TVA DEPTH	0 - 100.0 [%]	00
40 2n 50	00 00 01	28 - 58	CC2 PITCH CONTROL	-24 - +24 [semitone]	40
40 2n 51	00 00 01	00 - 7F	CC2 TVF CUTOFF CONTROL	-9600 - +9600 [cent]	40
40 2n 52	00 00 01	00 - 7F	CC2 AMPLITUDE CONTROL	-100.0 - +100.0 [%]	40
40 2n 53	00 00 01	00 - 7F	CC2 LFO1 RATE CONTROL	-10.0 - +10.0 [Hz]	40
40 2n 54	00 00 01	00 - 7F	CC2 LFO1 PITCH DEPTH	0 - 600 [cent]	00
40 2n 55	00 00 01	00 - 7F	CC2 LFO1 TVF DEPTH	0 - 2400 [cent]	00
40 2n 56	00 00 01	00 - 7F	CC2 LFO1 TVA DEPTH	0 - 100.0 [%]	00
40 2n 57	00 00 01	00 - 7F	CC2 LFO2 RATE CONTROL	-10.0 - +10.0 [Hz]	40
40 2n 58	00 00 01	00 - 7F	CC2 LFO2 PITCH DEPTH	0 - 600 [cent]	00
40 2n 59	00 00 01	00 - 7F	CC2 LFO2 TVF DEPTH	0 - 2400 [cent]	00
40 2n 5A	00 00 01	00 - 7F	CC2 LFO2 TVA DEPTH	0 - 100.0 [%]	00

[INFORMATION] ----- RQ1 ONLY -----

*r: ROM number (0 - 2)

Address(H)	SIZE(H)	Data(H)	Parameter	Description
40 30 00	00 00 20	20 - 7F	SYSTEM	ASCII Character
:	#		INFORMATION	"GS Standard VER=1.11
:	#			47 53 20 53 74 61 6E 64 61 72 64 20 20 56 45 52
:	#			3D 31 2E 31 31 20 20 20 20 20 20 20 20 20 20
40 30 1F#				

[DRUM SETUP PARAMETER]

*m: Map number (0 = MAP1, 1 = MAP2)
 *rr: drums part key number (00 - 7F)

Address(H)	SIZE(H)	Data(H)	Parameter	Description
41 m0 00	00 00 0C	20 - 7F	DRUMS MAP NAME	ASCII Character
:	#			
41 m0 0B#				
41 m1 rr	00 00 01	00 - 7F	PLAY KEY NUMBER	Pitch coarse (=Bx 63 18 62 rr 06 vv)
41 m2 rr	00 00 01	00 - 7F	LEVEL	TVA level (=Bx 63 1A 62 rr 06 vv)
41 m3 rr	00 00 01	00 - 7F	ASSIGN GROUP NUMBER	Non, 1 - 127
41 m4 rr	00 00 01	00 - 7F	PANPOT	Random, -63 (LEFT) - +63 (RIGHT) (=Bx 63 1C 62 rr 06 vv)
41 m5 rr	00 00 01	00 - 7F	REVERB DEPTH	0.0 - 1.0 Multiplicand of the part reverb depth (=Bx 63 1D 62 rr 06 vv)
41 m6 rr	00 00 01	00 - 7F	CHORUS DEPTH	0.0 - 1.0 Multiplicand of the part chorus depth
41 m7 rr	00 00 01	00 - 01	Rx. NOTE OFF	OFF / ON
41 m8 rr	00 00 01	00 - 01	Rx. NOTE ON	OFF / ON

[Bulk Dump]

1 - packet = 128 byte (MIDI)

--- PATCH ALL (64 + (112 * 16) = 0x740 byte)
 --- 0x740 * 2 (nibblize) = 1D 00 (MIDI)

Address(H)	SIZE(H)	Data(H)	Parameter	Description
48 00 00	00 1D 00			
:	#			29 packets
48 1C 7F#				

--- PATCH COMMON (64 = 0x40 byte)
 --- 0x40 * 2 (nibblize) = 01 00 (MIDI)

Address(H)	SIZE(H)	Data(H)	Parameter	Description
48 00 00	00 01 00			
:	#			1 packet
48 00 7F#				

--- PATCH PART (112 = 0x70 byte)
 --- 0x70 * 2 (nibble) = 01 60 (MIDI)

Address (H)	SIZE (H)	Data (H)	Parameter	Description
48 01 00	00 01 60	#	PART10	2 packet
48 02 5F	#			
48 02 60	00 01 60	#	PART11	2 packet
48 04 3F	#			
48 04 40	00 01 60	#	PART2	2 packet
48 06 1F	#			
48 06 20	00 01 60	#	PART3	2 packet
48 07 7F	#			
48 08 00	00 01 60	#	PART4	2 packet
48 09 5F	#			
48 09 60	00 01 60	#	PART5	2 packet
48 0B 3F	#			
48 0B 40	00 01 60	#	PART6	2 packet
48 0D 1F	#			
48 0D 20	00 01 60	#	PART7	2 packet
48 0E 7F	#			
48 0F 00	00 01 60	#	PART8	2 packet
48 10 5F	#			
48 10 60	00 01 60	#	PART9	2 packet
48 12 3F	#			
48 12 40	00 01 60	#	PART11	2 packet
48 14 1F	#			
48 14 20	00 01 60	#	PART12	2 packet
48 15 7F	#			
48 16 00	00 01 60	#	PART13	2 packet
48 17 5F	#			
48 17 60	00 01 60	#	PART14	2 packet
48 19 3F	#			
48 19 40	00 01 60	#	PART15	2 packet
48 1B 1F	#			
48 1B 20	00 01 60	#	PART16	2 packet
48 1C 7F	#			

--- DRUM MAP PARAMETER (128 = 80h)
 0x80 * 2 (nibble) = 00 02 00 (MIDI)

Address (H)	SIZE (H)	Parameter	Description
49 m0 00	00 02 00		PLAY KEY NUMBER 2 packet
49 m1 7F			
49 m2 00	00 02 00		LEVEL 2 packet
49 m3 7F			
49 m4 00	00 02 00		ASSIGN GROUP 2 packet
49 m5 7F		NUMBER	
49 m6 00	00 02 00		PANPOT 2 packet
49 m7 7F			
49 m8 00	00 02 00		REVERB DEPTH 2 packet
49 m9 7F			

49 mA 00	00 02 00		CHORUS DEPTH 2 packet
49 mB 7F			
49 mC 00	00 02 00		Rx. NOTE ON/OFF 2 packet
49 mD 7F			
49 mE 00	00 00 18		DRUM MAP NAME 1 packet
49 mE 17			

m: map number (0 - 1)

Micro Edit

Parameter values used in exclusive messages can be modified directly by using panel procedures.

* While in the Micro Edit status, press the INSTRUMENT buttons (◀ and ▶) simultaneously to transmit the displayed parameter values from MIDI OUT.

< Modifying System, Drum Set, and All Part parameters >

- ① After turning the [ALL] button indicator on, press the PART buttons (◀ and ▶) simultaneously.
- ② Press [ALL] and [MUTE] quickly two times simultaneously. The value (hexidecimal numbers) will be shown in the upper section of the display indicating the Micro Edit status.
- ③ Use [ALL] [MUTE] to select parameter address that you want to modify (in the Drum Set's case, use PART [◀ ▶] to select the key number).
- ④ Use INSTRUMENT [◀ ▶] to modify the value.
- ⑤ After pressing [ALL] and [MUTE] simultaneously, press the PART buttons (◀ and ▶) to finalize.

< Modifying parameters that can be set for each part >

- ① After turning the [ALL] button indicator off, press the PART buttons (◀ and ▶) simultaneously.
- ② Press [ALL] and [MUTE] quickly two times simultaneously. The value (hexidecimal numbers) will be shown in the upper section of the display indicating the Micro Edit status.
- ③ Use PART [◀ ▶] to select the part.
- ④ Use [ALL] [MUTE] to select the parameter address that you want to modify.
- ⑤ Use INSTRUMENT [◀ ▶] to modify the value.
- ⑥ After pressing [ALL] and [MUTE] simultaneously, press the PART buttons (◀ and ▶) to finalize.

- Function ...		Transmitted	Recognized	Remarks
Basic Channel	Default	×	1 - 16	Memorized
	Changed	×	1 - 16 each	
Mode	Default	×	Mode 3	* 2
	Messages	×	Mode 3, 4 (m = 1)	
	Altered	*****		
Note Number	True Voice	×	0 - 127	
		*****	0 - 127	
Velocity	Note ON	×	○	
	Note OFF	×	×	
After Touch	Key's	×	* 1	
	Ch's	×	* 1	
Pitch Bender		×	* 1	Resolution : 12 bit
Control Change	0, 32	×	* 3 (MSB only)	Bank select
	1	×	* 1	Modulation
	5	×	* 3	Portamento time
	6, 38	×	* 3	Data entry
	7	×	* 1	Volume
	10	×	* 1	Panpot
	11	×	* 1	Expression
	64	×	* 1	Hold1
	65	×	* 1	Portamento
	66	×	* 1	Sostenuto
	67	×	* 1	Soft
	91	×	* 3 (Reverb)	Effect1 depth
	93	×	* 3 (Chorus)	Effect3 depth
	98, 99	×	* 1	NRPN LSB, MSB
	100, 101	×	* 1	RPN LSB, MSB
	120	×	○	All sounds off
121	×	○	Reset all controllers	
Prog Change	True #	×	* 1 0 - 127	
System Exclusive		○	○	
System Common	Song Pos	×	×	
	Song Sel	×	×	
	Tune	×	×	
System Real Time	Clock	×	×	
	Commands	×	×	
Aux Messages	Local ON/OFF	×	×	
	All Notes OFF	×	○ (123 - 127)	
	Active Sense	○	○	
	Reset	×	×	
Notes	* 1 ○× can be selectable. * 2 Recognize as m = 1 even if m ≠ 1. * 3 ○× can be selectable, only using the receive switch control change (all).			

Mode 1 : OMNI ON, POLY

Mode 2 : OMNI ON, MONO

○ : Yes

Mode 3 : OMNI OFF, POLY

Mode 4 : OMNI OFF, MONO

× : No

■ How to read the MIDI Implementation chart

- : MIDI messages that can be transmitted or received
- × : MIDI messages that cannot be transmitted or received

● Basic Channel

The MIDI channel for transmitting (receiving) MIDI messages can be specified over this range. The MIDI channel setting is remembered even when the power is turned off.

● Mode

Most recent keyboards use mode 3 (omni off, poly).

Reception : MIDI messages are received only on the specified channels, and played polyphonically.

Transmission : All musical data is transmitted on the specified MIDI channel.

* "Mode" refers to MIDI Mode messages.

● Note Number

This is the range of note numbers that can be transmitted (received. Note number 60 is middle C (C4))

● Velocity

This is the range over which velocity can be transmitted (received) by Note On and Note Off messages.

● Aftertouch

Key's : polyphonic aftertouch

Ch's : channel aftertouch

● Pitch Bender

Set the receiving range of Pitch Bender messages by using Bend Range of each part.

● Control Change

This indicates the control numbers that can be transmitted (received), and what they will control. For details, refer to the MIDI Implementation.

● Program Change

The program change numbers in the chart indicate the actual data. (This is one less than the instrument program numbers.)

● Exclusive

Exclusive message reception can be turned on/off by the exclusive message receiving switch.

● Common, Realtime

These MIDI messages are used to synchronize sequencers and rhythm machines.

The Sound Canvas does not use these messages.

● Other

These messages are mainly used to keep a MIDI system running correctly.

Active sensing transmission can be turned on/off.

SPECIFICATIONS

SC-55 Sound Canvas

(GS standard response)

Sound Canvas

● Number of parts

16 (Two parts can be set in the drum part)

● Maximum Polyphony

24 (partials)

● Effects

Reverb

Chorus

● Display

70.6 x 24.5mm (backlit LCD)

● Connectors

MIDI connectors (IN × 2, OUT, THRU)

Audio Input jack × 2 (L, R)

Audio Output jack × 2 (L, R)

Headphone jack

● Power supply

DC 9V (AC adaptor)

● Current Draw

500 mA

● Dimensions

218 (W) × 44 (D) × 297 (H) mm

8-9/16 (W) × 11-11/16 (D) × 1-3/4 (H) inches

half-rack size

● Weight

1.4 kg

3.1 lbs

Remote control unit

● Operating range

Distance: approximately 5 m

Angle: 40 degrees

● Power supply

DC 3V (CR2025 lithium battery)

● Dimensions

54 (W) × 4.9 (D) × 85.5 (H) mm

2-1/8 (W) × 3/16 (D) × 3-3/8 (H) inches

Accessories

Owner's manual

AC adaptor

MIDI cable (1 m) × 1

Remote control unit

Lithium battery (CR2025)

Audio cable (RCA pin ↔ RCA pin <1/4 inch phone type>)

* The included MIDI cable is for MIDI only. It cannot be used for other purposes.

Options

Rack mount adaptor (RAD-50)

* The specifications for this product are subject to change without prior notice.

SOUND Canvas INSTRUMENT TABLE

Program number
(Number of partials)
Instrument name

Plano	Piano 1	Piano 2	Piano 3	Honky-Tonk Piano	E. Piano 1	E. Piano 2	Harpischord	Clav.
Chromatic Percussion	Celesta	Glockenspiel	Music Box	Vibraphone	Marimba	Xylophone	Tubular-bell	Santur
Organ	Organ 1	Organ 2	Organ 3	Church Org. 1	Reed Organ	Accordion Fr	Harmonica	Bandneon
Guitar	Nylon-str. Gt	Steel-Str. Gt	Jazz Gt.	Clean Gt.	Muted Gt.	Overdrive Gt	DistortionGt	Gt. Harmonics
Bass	Acoustic Bs.	Fingered Bs.	Picked Bs.	Fretless Bs.	Slap Bs. 1	Slap Bs. 2	Synth Bass 1	Synth Bass 2
Strings/orchestra	Violin	Viola	Cello	Contrabass	Tremolo Str	PizzicatoStr	Harp	Trimpani
Ensemble	Strings	Slow Strings	Syn. Strings1	Syn. Strings2	Choir Aahs	Voice Oohs	SynVox	OrchestraHit
Brass	Trumpet	Trombone	Tuba	MutedTrumpet	French Horn	Brass 1	Synth Brass1	Synth Brass2
Lead	Soprano sax	Alto sax	Tenor sax	Baritone sax	Oboe	English Horn	Bassoon	Clarinet
Pipe	Piccocolo	Fule	Recorder	Pan flute	Bottle Blow	Shakuhachi	Whistle	Ocarina
Synth lead	Square Wave	Saw Wave	Syn. Calliope	Chiffir Lead	Charang	Solo Vox	5th Saw Wave	Bass&Lead
Synth pad etc.	Fantasia	Warm Pad	Polysynth	Space Voice	Bowed Glass	Metal Pad	Halo Pad	Sweep Pad
Synth SFX	Ice Rain	Soundtrack	Crystal	Atmosphere	Brightness	Goblin	Echo Drops	Star Theme
Ethnic	Sitar	Banjo	Shamisen	Koto	Kalimba	Bag Pipe	Fiddle	Shanai
Percussive	Tinkle Ball	Agogo	Steel Drums	Woodblock	Talko	Melo Tom 1	Synth Drum	Reverse Gym.
SFX	Gt. GrainNoise	Gt. Kkeyclick	Seashore	Bird	Telephone 1	Helicopter	Applause	Gun Shot

The above items are capital instruments. For variation instruments see P. 68.

SOUND Canvas DRUM SET TABLE

Note number	1:Standard Set 33:Jazz Set	9:Room Set	17:Power Set	25:Electronic Set	26:TR-808 Set	41:Brush Set	49:Orchestra Set
28	27 High O						Closed Hi-Hat [EXC1]
	Slap						Pedal Hi-Hat [EXC1]
29	Scratch Push						Open Hi-Hat [EXC1]
	30 Scratch Pull						Hi-Hat Cymbal
31	Sticks						
32	Square Click						
33	Metronome Click						
34	Metronome Bell						
35	Kick Drum 2						Concert BD 2
36	Kick Drum 1		MONDO Kick	Elec BD	808 Bass Drum		Concert BD 1
	37 Slide Stick				808 Rim Shot		
38	Snare Drum 1		Gated SD	Elec SD	808 Snare Drum	Brush Tap	Concert SD
39	Hand Clap					Brush Slab	Castanets
	Snare Drum 2			Gated SD		Brush Swirl	Concert SD
41	Low Tom 2	Room Low Tom 2	Room Low Tom 2	Elec Low Tom 2	808 Low Tom 2		Timpani F
42	Closed Hi - hat [EXC1]				808 CHH [EXC1]		Timpani F#
43	Low Tom 1	Room Low Tom 1	Room Low Tom 1	Elec Low Tom 1	808 Low Tom 1		Timpani G
44	Pedal Hi - hat [EXC1]				808 CHH [EXC1]		Timpani G#
45	Mid Tom 2	Room Mid Tom 2	Room Mid Tom 2	Elec Mid Tom 2	808 Mid Tom 2		Timpani A
46	Open Hi - hat [EXC1]				808 OHH [EXC1]		Timpani A#
47	Mid Tom 1	Room Mid Tom 1	Room Mid Tom 1	Elec Mid Tom 1	808 Mid Tom 1		Timpani B
48	High Tom 2	Room Hi Tom 2	Room Hi Tom 2	Elec Hi Tom 2	808 Hi Tom 2		Timpani c
	49 Crash Cymbal 1				808 Cymbal		Timpani c#
50	High Tom 1	Room Hi Tom 1	Room Hi Tom 1	Elec Hi Tom 1	808 Hi Tom 1		Timpani d
51	Ride Cymbal 1						Timpani d#
	Chinese Cymbal			Reverse Cymbal			Timpani e
53	Ride Bell						Timpani f
54	Tambourine						
55	Splash Cymbal						
56	Cowbell				808 Cowbell		
57	Crash Cymbal 2						Concert Cymbal 2
58	Vibra - slap						
59	Ride Cymbal 2						Concert Cymbal 1
60	High Bongo						
61	Low Bongo						
62	Mute High Conga				808 High Conga		
63	Open High Conga				808 Mid Conga		
64	Low Conga				808 Low Conga		
65	High Timbale						
66	Low Timbale						
67	High Agogo						
68	Low Agogo						
69	Cabasa						
70	Maracas				808 Maracas		
71	Short Hi Whistle [EXC2]						
	72 Long Low Whistle [EXC2]						
73	Short Guiro [EXC3]						
74	Long Guiro [EXC3]						
75	Claves				808 Claves		
76	High Wood Block						
77	Low Wood Block						
78	Mute Culca [EXC4]						
79	Open Culca [EXC4]						
80	Mute Triangle [EXC5]						
81	Open Triangle [EXC5]						
82	Shaker						
83	Jingle Bell						
84	Belltone						
85	Castanets						
86	Mute Surdo [EXC6]						
87	Open Surdo [EXC6]						
88							Applause

Blank : Same as the percussion sound of "Standard"
 ----- : No sound
 [EXC] : Percussion sound of the same number will not be heard at the same time.

*In addition to the above, the SFX set and CM-32L (CM-64) set are also available (P.71).

For the U.K.

IMPORTANT: THE WIRES IN THIS MAINS LEAD ARE COLOURED IN ACCORDANCE WITH THE FOLLOWING CODE.

BLUE : NEUTRAL
BROWN : LIVE

As the colours of the wires in the mains lead of this apparatus may not correspond with the coloured markings identifying the terminals in your plug proceed as follows:

The wire which is coloured BLUE must be connected to the terminal which is marked with the letter N or coloured BLACK.

The wire which is coloured BROWN must be connected to the terminal which is marked with the letter L or coloured RED.

For Nordic Countries

Apparatus containing Lithium batteries

ADVARSEL!

Lithiumbatteri – Eksplosionsfare ved fejlagtig håndtering.
Udskiftning må kun ske med batteri af samme fabrikat og type.
Levér det brugte batteri tilbage til leverandøren.

VARNING!

Explosionsfara vid felaktigt batteribyte.
Använd samma batterityp eller en ekvivalent typ som rekommenderas av apparatillverkaren.
Kassera använt batteri enligt fabrikantens instruktion.

ADVARSEL!

Lithiumbatteri – Eksplosionsfare.
Ved udstiftning benyttes kun batteri som anbefalt av apparatfabrikanten.
Brukt batteri returneres apparatleverandøren.

VAROITUS!

Paristo voi räjähtää, jos se on virheellisesti asennettu.
Vaihda paristo ainoastaan laitevalmistajan suosittelemaan tyyppiin. Hävitä käytetty paristo valmistajan ohjeiden mukaisesti.

For Germany

Bescheinigung des Herstellers/Importeurs

Hiermit wird bescheinigt, daß der/die/das

Roland Sound Canvas SC-55

(Gerät. Typ. Bezeichnung)

in Übereinstimmung mit den Bestimmungen der

Amtsbl. Vfg 1046/1984

(Amtsblattverfügung)

funk-entstört ist.

Der Deutschen Bundespost wurde das Inverkehrbringen dieses Gerätes angezeigt und die Berechtigung zur Überprüfung der Serie auf Einhaltung der Bestimmungen eingeräumt.

Roland Corporation Osaka/Japan

Name des Herstellers/Importeurs

For the USA

RADIO AND TELEVISION INTERFERENCE

WARNING — This equipment has been verified to comply with the limits for a Class B computing device, pursuant to Subpart J, of Part 15, of FCC rules. Operation with non-certified or non-verified equipment is likely to result in interference to radio and TV reception.

The equipment described in this manual generates and uses radio frequency energy. If it is not installed and used properly, that is, in strict accordance with our instructions, it may cause interference with radio and television reception. This equipment has been tested and found to comply with the limits for a Class B computing device in accordance with the specifications in Subpart J, of Part 15, of FCC Rules. These rules are designed to provide reasonable protection against such a interference in a residential installation. However, there is no guarantee that the interference will not occur in a particular installation. If this equipment does cause interference to radio or television reception, which can be determined by turning the equipment on and off, the user is encouraged to try to correct the interference by the following measure:

- Disconnect other devices and their input/output cables one at a time. If the interference stops, it is caused by either the other device or its I/O cable. These devices usually require Roland designated shielded I/O cables. For Roland devices, you can obtain the proper shielded cable from your dealer. For non Roland devices, contact the manufacturer or dealer for assistance.

If your equipment does cause interference to radio or television reception, you can try to correct the interference by using one or more of the following measures.

- Turn the TV or radio antenna until the interference stops.
- Move the equipment to one side or the other of the TV or radio.
- Move the equipment farther away from the TV or radio.
- Plug the equipment into an outlet that is on a different circuit than the TV or radio. (That is, make certain the equipment and the radio or television set are on circuits controlled by different circuit breakers or fuses.)
- Consider installing a rooftop television antenna with coaxial cable lead-in between the antenna and TV. If necessary, you should consult your dealer or an experienced radio/television technician for additional suggestions. You may find helpful the following booklet prepared by the Federal Communications Commission:
"How to Identify and Resolve Radio — TV Interference Problems"

This booklet is available from the U.S. Government Printing Office, Washington, D.C., 20402, Stock No. 004-000-00345-4.

For Canada

CLASS B

NOTICE

This digital apparatus does not exceed the Class B limits for radio noise emissions set out in the Radio Interference Regulations of the Canadian Department of Communications.

CLASSE B

AVIS

Cet appareil numérique ne dépasse pas les limites de la classe B au niveau des émissions de bruits radioélectriques fixés dans le Règlement des signaux parasites par le ministère canadien des Communications.

