

Blu-ray Disc Player



Contact SAMSUNG WORLD WIDE

If you have any questions or comments relating to Samsung products, please contact the SAMSUNG customer care center.

☎ 1-800-SAMSUNG (7267864)/www.samsung.com

Samsung Electronics America, Inc.
105 Challenger Road
Ridgefield Park, NJ 07660-0511
1-800-SAMSUNG (7267864)
www.samsung.com



User's Manual
BD-P1000

Warning



TO REDUCE THE RISK OF ELECTRIC SHOCK, DO NOT REMOVE THE COVER(OR BACK). NO USER-SERVICEABLE PARTS ARE INSIDE. REFER SERVICING TO QUALIFIED SERVICE PERSONNEL.

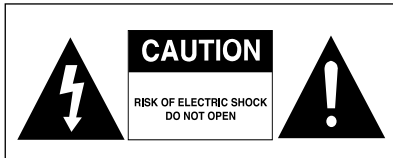

This symbol indicates “dangerous voltage” inside the product that presents a risk of electric shock or personal injury.



This symbol indicates important instructions accompanying the product.

Do not install this equipment in a confined space such as a bookcase or similar unit.

WARNING

To prevent damage which may result in fire or electric shock hazard, do not expose this appliance to rain or moisture.

Note to CATV system installer

This reminder is provided to call CATV system installer’s attention to Article 820-40 of the National Electrical Code (Section 54 of Canadian Electrical Code, Part I) that provides guidelines for proper grounding and, in particular, specifies that the cable ground shall be connected to the grounding system of the building as close to the point of cable entry as practical.

FCC NOTE (for U.S.A):

This equipment has been tested and found to comply with the limits for a Class B digital device, pursuant to Part 15 of the FCC rules. These limits are designed to provide reasonable protection against harmful interference in a residential installation. This equipment generates, uses and can radiate radio frequency energy and, if not installed and used in accordance with the instructions, may cause harmful interference to radio or television reception, which can be determined by turning the equipment off and on.

The user is encouraged to try to correct the interference by one or more of the following measures.

- Reorient or relocate the receiving antenna.
- Increase the separation between the equipment and receiver.

- Connect this equipment into an outlet on a circuit different from that to which the receiver is connected.
 - Consult the dealer or an experienced radio/TV technician for help.
- This class B digital apparatus meets all requirements of the Canadian Interference -- Causing Equipment Regulations.

CLASS 1 LASER PRODUCT
KLASSE 1 LASER PRODUKT
LUOKAN 1 LASER LAITE
KLASS 1 LASER APPARAT
PRODUCTO LÁSER CLASE 1

CAUTION

THIS PRODUCT UTILIZES A LASER. USE OF CONTROLS OR ADJUSTMENTS OR PERFORMANCE OF PROCEDURES OTHER THAN THOSE SPECIFIED HEREIN MAY RESULT IN HAZARDOUS RADIATION EXPOSURE. DO NOT OPEN COVER AND DO NOT REPAIR YOURSELF. REFER SERVICING TO QUALIFIED PERSONNEL.

Note:

- This unit can be used only where the power supply is AC 120V, 60Hz. It cannot be used elsewhere.
 - This Blu-ray disc player is designed and manufactured to respond to the Region Management Information.
- If the Region number of a BD/DVD disc does not correspond to the Region number of this Blu-ray disc player, the Blu-ray disc player cannot play the disc.

Precautions

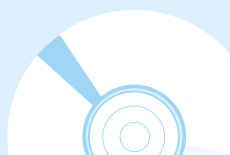

Important Safety Instructions

Read these operating instructions carefully before using the unit. Follow all the safety instructions listed below. Keep these operating instructions handy for future reference.

- 1) Read these instructions.
- 2) Keep these instructions.
- 3) Heed all warnings.
- 4) Follow all instructions.
- 5) Do not use this apparatus near water.
- 6) Clean only with dry cloth.
- 7) Do not block any ventilation openings, Install in accordance with the manufacturer's instructions.
- 8) Do not install near any heat sources such as radiators, heat registers, or other apparatus (including amplifiers) that produce heat.
- 9) Do not defeat the safety purpose of the polarized or grounding-type plug. A polarized plug has two blades with one wider than the other. A grounding type plug has two blades and a third grounding prong. The wide blade or the third prong are provided for your safety. If the provided plug does not fit into your outlet, consult an electrician for replacement of the obsolete outlet.
- 10) Protect the power cord from being walked on or pinched particularly at plugs, convenience receptacles, and the point where they exit from the apparatus.
- 11) Only use attachments/accessories specified by the manufacturer.
- 12) Use only with cart, stand, tripod, bracket, or table specified by the manufacturer, or sold with the apparatus.
- 13) Unplug this apparatus. When a cart is used, use caution when moving the cart/apparatus combination to avoid injury from tip-over.
- 14) Refer all servicing to qualified service personnel. Servicing is required when the apparatus has been damaged in any way, such as power-supply cord or plug is damaged, liquid has been spilled or objects have fallen into the apparatus the apparatus has been exposed to rain or moisture, does not operate normally, or has been dropped.



Handling Cautions

- Before connecting other components to this Blu-ray disc player, be sure to turn them all off.
- Do not move the Blu-ray disc player while a disc is being played, or the disc may be scratched or broken, the Blu-ray disc player internal parts may be damaged.
- Do not put a flower vase filled with water or any small metal objects on the Blu-ray disc player.
- Be careful not to put your hand into the disc tray.
- Do not place anything other than the disc in the disc tray.
- Exterior interference such as lightning and static electricity can affect normal operation of this Blu-ray disc player. If this occurs, turn the Blu-ray disc player off and on again with the POWER button, or disconnect and then reconnect the AC power cord to the AC power outlet. The Blu-ray disc player will operate normally.
- Be sure to remove the disc and turn off the Blu-ray disc player after use.
- Disconnect the AC power cord from the AC outlet when you don't intend to use the Blu-ray disc player for long periods of time.
- Clean the disc by wiping in a straight line from the inside to the outside of the disc.

Maintenance of Cabinet

For safety reasons, be sure to disconnect the AC power cord from the AC outlet.

- Do not use benzene, thinner, or other solvents for cleaning.
- Wipe the cabinet with a soft cloth.

Restrictions on Playback

- This player may not respond to all operating commands because some BD, DVD or CD discs allow specific or limited operation and feature during playback. Please note that this is not a defect in the player.
- Samsung cannot assure that this player will play every disc bearing the BD, DVD and CD logos because disc formats may evolve, and problems and errors can occur during the creation of BD, DVD and CD software and/or the manufacture of discs. This player also operates differently than a standard DVD player or other AV equipment. Please contact SAMSUNG customer care center if you have questions or encounter difficulty in playing BD, DVD or CD discs in this player. Also, refer to the rest of this Manual for additional information on playback restrictions.

General Features

Player Features

Digital Photo Viewer (JPEG)

You can enjoy digital photos on your TV.

MP3 Playback

This unit can play mp3 files from CD-R/-RW, DVD-R/-RW/-RAM, Memory Cards.

HDMI (High Definition Multimedia Interface)

HDMI reduces picture noise by allowing a pure digital video/audio signal path from the player to your TV.

Memory card capability

Compatible with 10 types of popular memory cards: Compact Flash, Micro Drive, Memory Stick, Memory Stick PRO, Memory Stick Duo, Memory Stick Pro Duo, Secure Digital, Multi Media, Mini SD, RS MMC.

Blu-ray Disc Features

Blu-ray Discs can store 25 GB (single layer) or 50 GB (dual layer) on a single sided disc - about 5 to 10 times the capacity of a DVD.

Blu-ray Discs also support the highest quality HD video available in the industry (up to 1920 x 1080 at 40 Mbit/sec) - Large capacity means no compromise on video quality. Furthermore, a Blu-ray Disc has the same familiar size and look as DVD.

* The following Blu-ray Disc features are disc dependant and will vary. Appearance and navigation of features will also vary from disc to disc. Not all discs will have the features described below.

Video highlights

The BD-ROM format for movie distribution supports three highly advanced video codecs, including MPEG-2.

HD video resolutions are also available:

- 1920 x 1080 HD
- 1280 x 720 HD

For High-Definition Playback

To view high-definition contents in BD discs, an HDTV is required. Some discs may require HDMI OUT for viewing of high-definition contents. Ability to view high-definition contents in BD discs may be limited depending on the resolution of your TV.

Graphic planes

Two individual, full HD resolution (1920x1080) graphic planes (layers) are available, on top of the HD video layer. One plane is assigned to video-related, frame accurate graphics (like subtitles), and the other plane is assigned to interactive graphic elements, such as buttons or menus.

For both planes, various wipes, fades and scroll effects may be available.

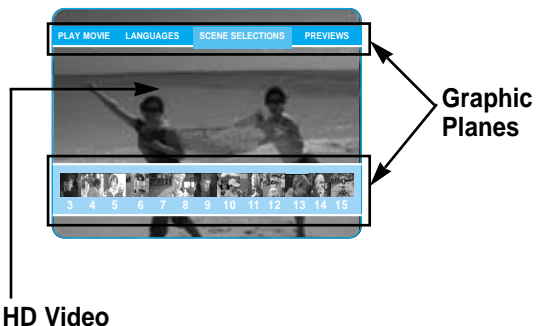

Menu graphics

Support 256 color full resolution graphics and animation, thereby greatly surpassing the capabilities of DVD-Video. Options can be accessed and removed during video playback.

Menu sounds

When you highlight or select a menu option, sounds can be heard such as button clicks or a voice-over explaining the highlighted menu choice.

Multi-page/PopUp Menus

With DVD-Video, playback is interrupted each time a new menu screen is accessed. Due to Blu-ray Disc's ability to preload data from the disc without interrupting playback, a menu can consist of several pages.

You can browse through the menu pages or select different menu paths, while the audio and video remain playing in the background.

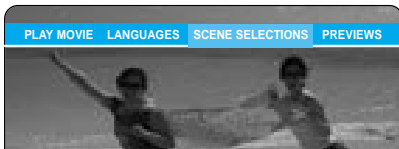

Interactivity

Certain Blu-ray Discs may contain Animated menus and Trivia games.

User Browsable Slideshows

With Blu-ray Discs, you can browse through various still pictures while the audio remains playing.















Subtitles

Depending on what is contained on the Blu-ray Disc, you may be able to select different font styles, sizes and colors for the subtitles, Subtitles may also be animated, scrolled or faded in and out.

Before Reading the User's Manual

Make sure to check the following terms before reading the user manual.

Icons that will be used in manual

Icon	Term	Definition
	BD-ROM	This involves a function available on the BD-ROM.
	BD-RE	This involves a function available on the BD-RE.
	BD-R	This involves a function available on the BD-R.
	DVD-VIDEO	This involves a function available on DVD-Video or DVD-R/DVD-RW discs that have been recorded and finalized in Video Mode.
	RAM	This involves a function available on DVD-RAM.(VR mode, Standard Version 2.0 only)
	RW	This involves a function available on DVD-RW.(VR mode, or V mode and finalized only)
	R	This involves a function available on BD-R.(V mode and finalized only)
	Audio CD	This involves a function available on a data CD (CD-R or CD-RW).
	JPEG	This involves a function available on CD-R/-RW, DVD-R/-RW/-RAM discs or memory card.
	MP3	This involves a function available on CD-R/-RW, DVD-R/-RW/-RAM discs or memory card.
	Memory Card	This involves a function available on the Memory Card.
	Caution	This involves a case where a function does not operate or settings may be cancelled.
	Note	This involves tips or instructions on the page that help each function operate.
	One-Touch button	A function that can be operated by using only one button.

About the use of this user's manual

- 1) Be sure to be familiar with Safety Instructions before using this product. (See pages 2~3)
- 2) If a problem occurs, check the Troubleshooting. (See pages 46~47)

Copyright

©2006 Samsung Electronics Co.,Ltd.

All rights reserved; No part or whole of this user's manual may be reproduced or copied without the prior written permission of Samsung Electronics Co.,Ltd.

Contents

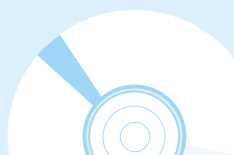

Getting Started

Warning	2
Precautions.....	3
Important Safety Instructions.....	3
Handling Cautions.....	3
Maintenance of Cabinet.....	3
General Features.....	4
Before Reading the User's Manual.....	5
Disc Type and Characteristics.....	8
Disc Storage & Management	11
Description.....	12
Front Panel	12
Rear Panel	13
Front Panel Display	13
Tour of the Remote Control.....	14
Unpacking	15

Connections

Quick Overview	17
TV Output Selection Feature	18
Choosing a Connection.....	18

Playback

Before Playing.....	24
Playing a Disc.....	25
Using the Search & Skip Functions	26
Slow Motion Play/Step Motion Play.....	26
Using the Scene Search Function.....	27
Using the Display Function.....	28
Using the Disc Menu & Popup/Title Menu	28
Repeat Play	29
Selecting the Audio Language	30
Selecting the Subtitle Language.....	30
Changing the Camera Angle.....	31
Using the Bookmark Function	31
Playing an Audio CD/ MP3	33
Viewing a Picture	35
Using a Mixed disc (JPEG+MP3)	38

System Setup

On-Screen Menu Navigation.....	39
Setting up the Language Options.....	40
Setting up the Audio Options	40
Setting up the Speaker Options.....	41
Setting up the Video display/output Options.....	42
Setting up the Parental Lock	44

Reference

Troubleshooting.....	46
Specifications	48

Disc Type and Characteristics

Disc types that can be played

Disc Types	Disc Logo	Recorded content	Disc Shape	Max. Playing minute
BD-ROM BD-RE BD-R		AUDIO + VIDEO	Single sided	-
DVD-VIDEO		AUDIO + VIDEO	Single sided(5 inches)	240
			Double sided(5 inches)	480
			Single sided(3 1/2 inches)	80
			Double sided(3 1/2 inches)	160
AUDIO-CD		AUDIO	Single sided(5 inches)	74
			Single sided(3 1/2 inches)	20
DVD-RAM (VR mode, Standard Version 2.0 only)		AUDIO + VIDEO	Single-sided 5 inches (4.7GB)	480 (EX : Extended Play)
			Double-sided 5 inches (9.4GB)	960 (EX : Extended Play)
DVD-RW (VR mode, or V mode and finalized only)		AUDIO + VIDEO	5 inches (4.7GB)	480 (EX : Extended Play)
DVD-R (V mode and finalized only)		AUDIO + VIDEO	5 inches (4.7GB)	480 (EX : Extended Play)
CD-R/-RW DVD-RAM/-RW/-R		JPEG MP3	-	-

- This player can play pictures of NTSC color system only.

Logos of Discs that can be played

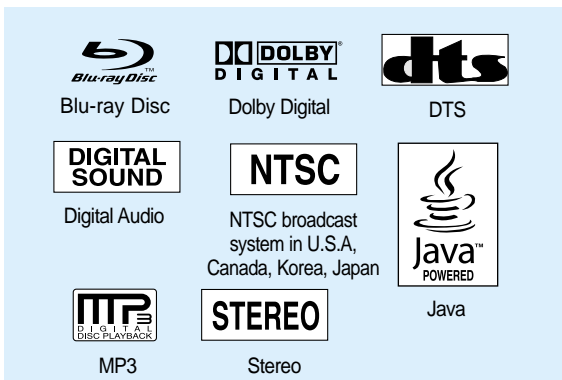

Do not use the following discs!

- HD DVD discs cannot be played on this product.
 - This product is not for playback of DVD+R and DVD+RW discs.
 - LD, CD-G, CD-I, CD-ROM, DVD-ROM and illegally recorded discs should not be used in this product.
- [Note]**
Disc types that can be played : BD-ROM/-RE/-R, DVD-Video, DVD-RAM/-RW/-R, CD, CD-RW/-R. DVD-RW/-R discs that have been recorded in Video Mode(V mode) on other components can play only when finalized.
- Some commercial discs and DVD discs purchased outside your region may not be playable with this product. When these discs are played, either "No disc." or "Please check the regional code of the disc." will be displayed.
 - If a DVD-R/-RW/-RAM disc has not been recorded properly in DVD video format, it will not be playable.

Region code

Both the Blu-ray disc player and the discs are coded by region. These regional codes must match in order to play the disc. If the codes do not match, the disc will not play. The Region Number for this Blu-ray disc player is described on the rear panel of the Blu-ray disc player.

Disc Type	Blu-ray	DVD-Video
Region code	Region A	

Discs that cannot be played

- HD DVD discs
- DVD-Video with a region number other than "1" or "ALL"
- 5 inch 2.6 GB and 5.2 GB DVD-RAM
- 3.9 GB DVD-R Disc for Authoring.
- DVD-RAM/-RW(VR mode) not recorded following the Video Recording Standard
- DVD-ROM/PD/MV-Disc, etc
- CVD/CD-ROM/CDV/CD-G/CD-I

Blu-ray Disc Compatibility

Blu-ray Disc is a new and evolving format. Accordingly, disc compatibility issues with new and existing format discs are possible. Not all discs are compatible and not every disc will playback. For additional information, also refer to the Compliance and Compatibility Notice section of this Manual. If you encounter compatibility problems, please contact SAMSUNG customer care center. Samsung Blu-ray disc player (BD-P1000) supports only **BD-ROM Profile 1 version 1.0** specification. In case of playing discs which has later version, you may need to update player's firmware. Please refer to <http://www.samsung.com> or contact SAMSUNG customer care center.



NOTE

- This Blu-ray disc player supports discs that are compatible with DVD-RAM Standard Version 2.0.
- Playback may not work for some types of discs, or when specific operations, such as angle change and aspect ratio adjustment, are being performed. Information about the discs is written in detail on the box. Please refer to this if necessary.
- Do not allow the disc to become dirty or scratched. Finger prints, dirt, dust, scratches or deposits of cigarette smoke on the recording surface may make it impossible to use the disc for playback.
- Discs with PAL programs recorded on them cannot be played using this product.

COPY PROTECTION

- Because AACS (Advanced Access Content System) is approved as content protection system for BD format, similar to use of CSS (Content Scramble System) for DVD format, certain restrictions are imposed on playback, analog signal output, etc., of AACS protected contents. The operation of this product and restrictions on this product may vary depending on your time of purchase as those restrictions may be adopted and/or changed by AACS after the production of this product. Furthermore, BD-ROM Mark and BD+ are additionally used as content protection system for BD format, which imposes certain restrictions including playback restrictions for BD-ROM Mark and/or BD+ protected contents. To obtain additional information on AACS, BD-ROM Mark, BD+, or this product, please contact SAMSUNG customer care center.
- Many BD/DVD discs are encoded with copy protection. Because of this, you should only connect your Blu-ray disc player directly to your TV, not to a VCR. Connecting to a VCR results in a distorted picture from copy-protected BD/DVD discs.
- This product incorporates copyright protection technology that is protected by methods claims of certain U.S. patents and other intellectual property rights owned by Macrovision Corporation and other rights owners. Use of this copyright protection technology must be authorized by Macrovision Corporation and is intended for home and other limited viewing uses only, unless otherwise authorized by Macrovision Corporation. Reverse engineering or disassembly is prohibited.
- Under the U.S. Copyright laws and Copyright laws of other countries, unauthorized recording, use, display, distribution, or revision of television programs, videotapes, BDs, DVDs, CDs and other materials may subject you to civil and/or criminal liability.

Disc Type

BD-ROM

Blu-ray Disc Read Only Memory. A BD-ROM disc contains pre-recorded data. Although a BD-ROM may contain any form of data, most BD-ROM discs will contain movies in High Definition format, for playback on Blu-ray disc players. This unit can play back pre-recorded commercial BD-ROM discs with movies.

BD-RE

Blu-ray Disc Rewritable. A BD-RE disc can be recorded over and over again. It offers extensive editing functionality on the disc. BD-RE is the ideal format for making sequential backups, or recording video for time shifting purposes. This unit can play back BD-RE discs with video recording for time shifting purposes.

BD-R

Blu-ray Disc Recordable. A BD-R disc can be recorded once, and cannot be accidentally erased. BD-R is the ideal format for archiving valuable data or storing and distributing personal video material. This unit can play back BD-R discs with video recording for time shifting purposes.

DVD-Video

- A digital versatile disc (DVD) can contain up to 135-minutes of images, 8 audio languages and 32 subtitle languages. It is equipped with MPEG-2 picture compression and Dolby Digital surround, allowing you to enjoy vivid and clear theatre quality images in the comfort of your own home.
- When switching from the first layer to the second layer of a dual-layered DVD Video disc, there may be momentary distortion in the image and sound. This is not a malfunction of the unit.
- Once a DVD-RW/-R recorded in Video Mode is finalized, it becomes DVD-Video. Pre-recorded (pre-stamped) commercial DVDs with movies are also referred to as DVD-Videos. This unit can play back pre-recorded commercial DVD discs (DVD-Video discs) with movies.

Audio CD

- An audio disc on which 44.1kHz PCM Audio is recorded.
- This unit can play back CD-DA format audio CD-R and CD-RW discs.
- The unit may not be able to play some CD-R or CD-RW discs due to the condition of the recording.

CD-R/-RW

- Use a 700MB(80 minutes) CD-R/-RW disc. If possible, do not use a 800MB(90 minutes) or above disc, as the disc may not play back.
- If the CD-R/-RW disc was not recorded as a closed session, you may experience a delay in the early playback time, all recorded files may not play.
- Some CD-R/-RW discs may not be playable with this unit, depending on the device which was used to burn them. For contents recorded on CD-R/-RW media from CDs for your personal use, playability may vary depending on contents and discs.

DVD-R Disc Playback

- Once a DVD-R recorded in Video Mode is finalized, it becomes DVD-Video.
- Playback may be impossible in some cases due to the condition of recording.
- This unit can play back DVD-R discs recorded and finalized with a Samsung DVD video recorder. It may not be able to play some DVD-R discs depending on the disc and the condition of the recording.

DVD-RW Disc Playback

- Playback can be performed with DVD-RW discs in both the Video and VR Modes.
- Once a DVD-RW recorded in Video Mode is finalized, it becomes DVD-Video. Ability to play back may depend on recording conditions.

DVD-RAM Disc Playback

- You cannot play a DVD-RAM in most DVD components due to compatibility issues.
- Only DVD-RAM standard Version 2.0. discs can be played in this unit.
- For cartridge type DVD-RAM discs, remove the cartridge and use the disc only.

Disc Format

Using MP3 disc

- CD-R/-RW, DVD-RAM/-RW/-R recorded with UDF, ISO9660 or JOLIET format can be played back.
- Only MP3 files with the ".mp3" or ".MP3" extension can be played.
- Playable bit-rate range is from 56 Kbps to 320 Kbps.
- Playable sample-rate is only 32 KHz, 44.1 KHz and 48 KHz.
- The unit can handle a maximum of 1500 files and folders under a parent folder.
For MP3 files recorded with a VBR(Variable Bit Rates), the sound may cut in and out.

Using JPEG disc

- CD-R/-RW, DVD-RAM/-RW/-R recorded with UDF, ISO9660 or JOLIET format can be played back.
- Only JPEG files with the ".jpg", ".JPG", ".jpeg" or "JPEG" extension can be displayed.
- Progressive JPEG is supported.

DVD-RAM/-RW (VR)

- This is a format that is used for recording data on a DVD-RAM/-RW disc.

DVD-RW/-R (V)

- This is a format that is used for recording data on a DVD-RW or DVD-R disc. The disc can be played by this Blu-ray disc player once it has been finalized.
- If a disc that has been recorded in Video Mode by a different maker's recorder but has not been finalized, it cannot be played by this Blu-ray disc player.

Compliance and Compatibility Notice

NOT ALL discs are compatible

- Subject to the restrictions described below and those noted throughout this Manual, including the Disc Type and Characteristics section of this Manual, disc types that can be played are: pre-recorded commercial BD-ROM, DVD-Video, and Audio CD discs; BD-RE/-R, DVD-RAM, and DVD-RW / DVD-R discs; and CD-RW / CD-R discs.
- Discs other than the above cannot and/or is not intended to be played by this player. And some of the above discs may not play due to one or more reasons provided below.
- HD DVD discs cannot be played in this player.
- Samsung cannot assure that this player will play every disc bearing the BD-ROM, BD-RE, BD-R, DVD-Video, DVD-RAM, DVD-RW / DVD-R and CD-RW / CD-R logos, and this player may not respond to all operating commands or operate all features of every disc. These and other disc compatibility and player operation issues with new and existing format discs are possible because:
 - BD format is a new and evolving format and this player may not operate all features of BD discs because some features may be optional, additional features may have been added to the BD format after the production of this player, and certain available features may be subject to delayed availability;
 - not all new and existing disc format versions are supported by this player;
 - new and existing disc formats may be revised, changed, updated, improved and/or supplemented;
 - some discs are produced in a manner that allows specific or limited operation and feature during playback;
 - some features may be optional, additional features may have been added after the production of this player or certain available features may be subject to delayed availability;
 - some discs bearing the BD-ROM, BD-RE, BD-R, DVD-Video, DVD-RAM, DVD-RW / DVD-R and CD-RW / CD-R logos may still be non-standardized discs;

- some discs may not be played depending on their physical state or recording conditions;
- problems and error can occur during the creation of BD, DVD and CD software and/or the manufacture of discs;
- this player operates differently than a standard DVD player or other AV equipment; and/or
- for reasons noted throughout this Manual and for other reason(s) discovered and posted by SAMSUNG customer care center.
- If you encounter disc compatibility or player operation problems, please contact SAMSUNG customer care center. You may also contact SAMSUNG customer care center for possible updates on this player.
- For additional information on playback restrictions and disc compatibility, refer to the Precautions, Before Reading the User's Manual, Disc Types and Characteristics, and Before Playing sections of this Manual.

Disc Storage & Management



Disc Handling

- Use discs with regular shapes. If an irregular disc (a disc with a special shape) is used, this Blu-ray disc player may be damaged.



Holding discs

- Avoid touching the surface of a disc where recording is performed.



Blu-ray Discs

- If the product is not used for a period of time, remove the Blu-ray Disc from the product and store it in its case.
- Be careful not to leave fingerprints or scratches on the surface of the Blu-ray Disc.

DVD-RAM, DVD-RW and DVD-R

- Clean with an optional DVD-RAM/PD disc cleaner (LF-K200DCA1 where available). Do not use cleaners or cloths for CDs to clean DVD-RAM/-RW/-R discs.

DVD-Video, Audio-CD

- Wipe off dirt or contamination on the disc with a soft cloth.

Cautions on handling discs

- Do not write on the printed side with a ball-point pen or pencil.
- Do not use record cleaning sprays or antistatic. Also, do not use volatile chemicals, such as benzene or thinner.
- Do not apply labels or stickers to discs. (Do not use discs fixed with exposed tape adhesive or leftover peeled-off stickers.)
- Do not use scratch-proof protectors or covers.
- Do not use discs printed with label printers available on the market.
- Do not load warped or cracked discs.



Disc Storage

Be careful not to harm the disc because the data on these discs is highly vulnerable to the environment.

- Do not keep under direct sunlight.
- Keep in a cool ventilated area.
- Store vertically.
- Keep in a clean protection jacket.
- If you move your Blu-ray disc player suddenly from a cold place to a warm place, condensation may generate on the operating parts and lens and cause abnormal disc playback. If this occurs, do not connect the plug to the power outlet and wait for two hours. Then insert the disc and try to play back again.

Description

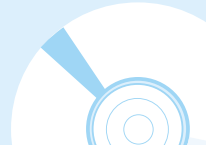

Front Panel

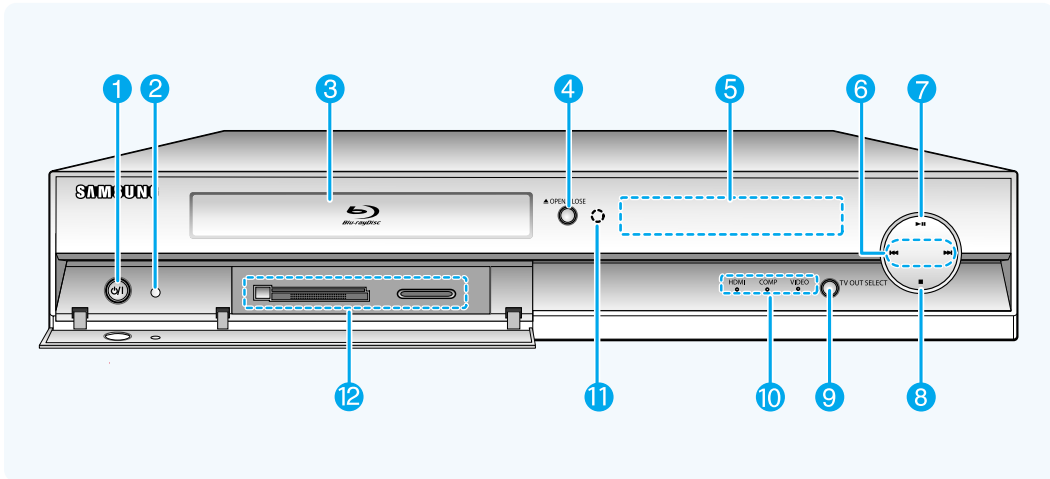

1. **POWER BUTTON**
Turns the Blu-ray disc player on and off.
2. **STANDBY INDICATOR**
When the unit is first plugged in, this indicator lights.
3. **DISC TRAY**
Opens to accept a disc.
4. **OPEN/CLOSE BUTTON**
Opens and closes the disc tray.
5. **DISPLAY**
Displays the playing status, time, etc.
6. **SEARCH/SKIP BUTTONS**
Goes to the next title/chapter/track or goes back to the previous title/chapter/track.
7. **PLAY/PAUSE BUTTON**
Plays a disc or pauses playback.
8. **STOP BUTTON**
Stops disc playback.
9. **TV OUT SELECT BUTTON**
Choose video output from HDMI or COMPONENT or VIDEO/S-VIDEO.
10. **VIDEO OUT INDICATORS**
 - HDMI INDICATOR : Lights when HDMI OUT mode is selected.
 - COMP INDICATOR : Lights when COMPONENT OUT mode is selected.
 - VIDEO INDICATOR : Lights when VIDEO or S-VIDEO OUT mode is selected.
11. **Remote Control Sensor**
12. **MEMORY CARD SLOT**
Insert a memory card here.

Rear Panel

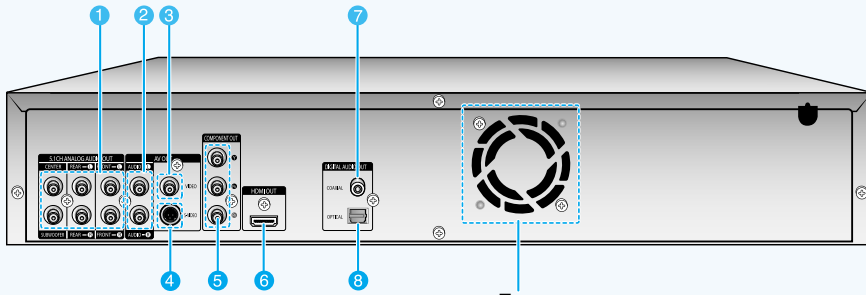

Fan

The fan always revolves when the power is on. Ensure a minimum of 4 inches of clear space on all sides of the fan when installing the product.

1. 5.1CH ANALOG AUDIO OUT

Connect to a 5.1CH analog input on an A/V amplifier

2. AUDIO OUT

Connects to the audio input of external equipment using audio cables.

3. VIDEO OUT

Connects the input of external equipment using a video cable.

4. S-VIDEO OUT

Connects the input of external equipment using an S-Video cable.

5. COMPONENT VIDEO OUT

Connects to equipment having Component video input.

6. HDMI OUT

Use the HDMI cable, connect this HDMI output terminal to the HDMI input terminal on your TV for the best quality picture.

7. DIGITAL AUDIO OUT(COAXIAL)

Connects to an amplifier having a digital coaxial audio input jack.

8. DIGITAL AUDIO OUT(OPTICAL)

Connects to an amplifier having a digital optical audio input jack.

Front Panel Display

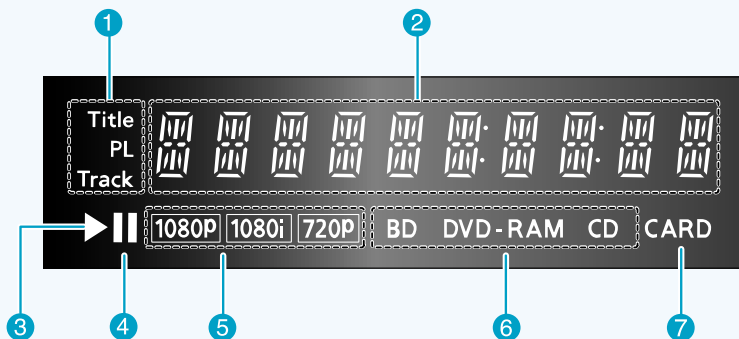

1. Title/PlayList/Track indicator

2. Playing time/clock/current status indicator

3. Playback indicator

4. Pause indicator

5. Video output resolution indicator

6. Disc type indicators.

7. Memory card indicator.

Tour of the Remote Control

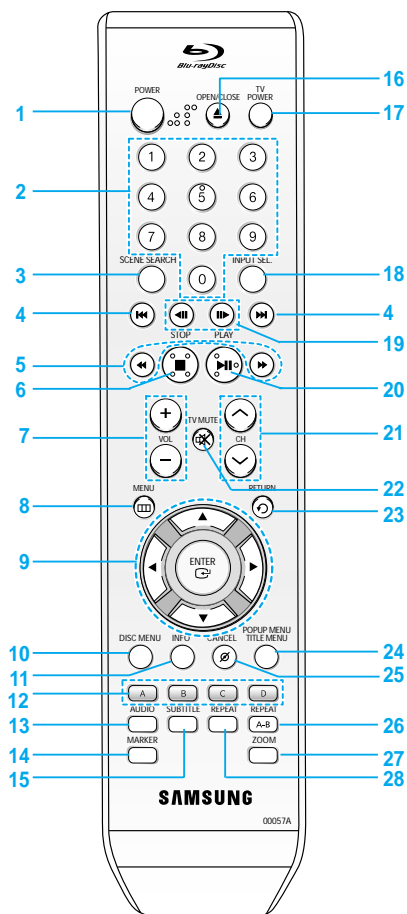

1. **POWER Button**
2. **NUMBER Buttons**
3. **SCENE SEARCH Button**
Easily search for desired scenes during playback with search categories such as Actor and Character.
4. **REVERSE/FORWARD SKIP Buttons**
Press to skip backwards or forwards.
5. **REVERSE/FORWARD SEARCH Buttons**
Press to search a disc backwards or forwards.
6. **STOP Button**
Press to stop a disc.
7. **VOL Button**
TV volume adjustment
8. **MENU Button**
Brings up the Blu-ray disc player's setup menu.
9. **ENTER/DIRECTION Buttons (▲▼◀▶ Buttons)**
10. **DISC MENU Button**
Use this to enter the disc menu.

11. **INFO Button**
This will display current setting or disc status.
12. **COLOR Button : RED(A), GREEN (B), YELLOW(C), BLUE(D)**
Allows access to common functions of the Blu-ray disc player.
13. **AUDIO Button**
Use this to access various audio functions on a disc (BD/DVD).
14. **MARKER Button**
Use this to bookmark a position while playing a disc.
15. **SUBTITLE Button**
Press this to switch the BD/DVD's subtitle language.
16. **OPEN/CLOSE Button**
To open and close the disc tray.
17. **TV POWER Button**
18. **INPUT SEL. Button**
Select among input terminals of TV.
19. **REVERSE/FORWARD STEP Buttons**
Each time this button is pressed, a new frame will appear.
20. **PLAY/PAUSE Button**
Press to play/pause a disc.
21. **CHANNEL Button**
Use this to select a TV program.
22. **TV MUTE Button**
Mutes the speakers of your TV.
23. **RETURN Button**
24. **POPUP MENU/TITLE MENU Button**
Use this to enter the popup menu/title menu.
25. **CANCEL Button**
26. **REPEAT A-B Button**
Allows you to repeat playback of the A-B section.
27. **ZOOM Button**
Enlarge JPEG Picture.
28. **REPEAT Button**
Allows you to repeat a title, chapter, track or disc.

Unpacking

Accessories

Check for the supplied accessories below.

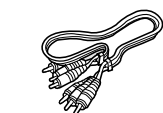

Component Cable
(MD39-00107A)



Composite (Video),
Audio L/R Cable
(MF39-00274A)

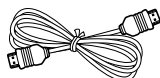

HDMI Cable
(MF39-00299A)



Batteries for Remote
Control (AAA Size)
(4301-001035)



Remote Control
(AK68-01118A)

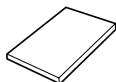

Instruction Manual
(AK68-01091A)

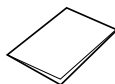

Quick Guide
(AK68-01118A)

Preparing the Remote Control

Install Batteries in the Remote Control

- Open the battery cover on the back of the remote control.
- Insert two AAA batteries. Make sure that the polarities (+ and -) are aligned correctly.
- Close the battery cover.

If the remote does not operate properly:

- Check the polarity + - of the batteries (Dry-Cell)
- Check if the batteries are drained.
- Check if remote sensor is blocked by obstacles.
- Check if there is any fluorescent lighting nearby.

Dispose of batteries according to local environmental regulations. Do not put them in the household trash.

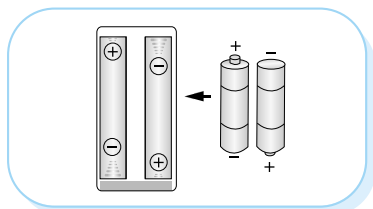

Setting the Remote Control

You can control certain functions of another manufacturer's TV with this remote control. Control function buttons include: **TV POWER**, **CH ^ v**, **VOL + -**, **TV MUTE**, **INPUT SEL.** button.

To determine whether your television is compatible, follow the instructions below.

1. Switch your television on.
2. Point the remote control towards the television.
3. Press and hold the **TV POWER** button and enter the two-figure code corresponding to the brand of your television, by pressing the appropriate number buttons.

Result: If your television is compatible with the remote control, it will switch off. It is now programmed to operate with the remote control.



NOTE

- If several codes are indicated for your television brand, try each one in turn until you find one that works.
- If you replace the remote control's batteries, you must set the brand code again.

Then you can control the television using the following buttons after pressing the TV button.

Button	Function
TV POWER	Used to switch the television on and off.
INPUT SEL.	Used to select an external source.
VOL (+ -)	Used to adjust the volume of the television.
CH (^ v)	Used to select the desired channel.
TV MUTE	Used to toggle the sound on and off.



NOTE

- The functions listed above will not necessarily work on all televisions. If you encounter problems, operate the television directly.

Controllable TV Codes

Brand	Code
SAMSUNG	TV POWER+01, +02, +03, +04, +05, +06, +07, +08, +09
AIWA	TV POWER+82
ANAM	TV POWER+10, +11, +12, +13, +14, +15, +16, +17, +18
BANG & OLUFSEN	TV POWER+57
BLAUPUNKT	TV POWER+71
BRANDT	TV POWER+73
BRIONVEGA	TV POWER+57
CGE	TV POWER+52
CONTINENTAL EDISON	TV POWER+75
DAEWOO	TV POWER+19, +20, +23, +24, +25, +26, +27, +28, +29, +30, +31, +32, +33, +34
EMERSON	TV POWER+64
FERGUSON	TV POWER+73
FINLUX	TV POWER+06, +49, +57
FORMENTI	TV POWER+57
FUJITSU	TV POWER+84
GRADIENTE	TV POWER+70
GRUNDIG	TV POWER+49, +52, +71
HITACHI	TV POWER+60, +72, +73, +75
IMPERIAL	TV POWER+52
JVC	TV POWER+61, +79
LG	TV POWER+06, +19, +20, +21, +22, +78
LOEWE	TV POWER+06, +69
LOEWE OPTA	TV POWER+06, +57
MAGNAVOX	TV POWER+40
METZ	TV POWER+57
MITSUBISHI	TV POWER+06, +48, +62, +65
MIVAR	TV POWER+52, +77
NEC	TV POWER+83
NEWSAN	TV POWER+68
NOBLEX	TV POWER+66
NOKIA	TV POWER+74
NORDMENDE	TV POWER+72, +73, +75
PANASONIC	TV POWER+53, +54, +74, +75
PHILIPS	TV POWER+06, +55, +56, +57
PHONOLA	TV POWER+06, +56, +57
PIONEER	TV POWER+58, +59, +73, +74
RADIOLA	TV POWER+06, +56
RADIOMARELLI	TV POWER+57
RCA	TV POWER+45, +46
REX	TV POWER+74
SABA	TV POWER+57, +72, +73, +74, +75
SALORA	TV POWER+74
SANYO	TV POWER+41, +42, +43, +44, +48
SCHNEIDER	TV POWER+06
SELECO	TV POWER+74
SHARP	TV POWER+36, +37, +38, +39, +48
SIEMENS	TV POWER+71
SINGER	TV POWER+57
SINUDYNE	TV POWER+57
SONY	TV POWER+35, +48
TELEVA	TV POWER+73
TELEFUNKEN	TV POWER+67, +73, +75, +76
THOMSON	TV POWER+72, +73, +75
THOMSON ASIA	TV POWER+80, +81
TOSHIBA	TV POWER+47, +48, +49, +50, +51, +52
WEGA	TV POWER+57
YOKO	TV POWER+06
ZENITH	TV POWER+63

Connections

This section involves various methods of connecting the Blu-ray disc player to other external components.

Quick Overview	17
TV Output Selection Feature	18
Choosing a Connection	18

Quick Overview

A Quick Overview presented in this guide will give you enough information to start using the Blu-ray disc player.

Connecting to a TV(Video)



Connecting to a TV (S-Video)



Connecting to a TV (Component)



Connecting to a TV with DVI Jack



Connecting to a TV with HDMI Jack



Connecting to an Audio System (2 Channel Amplifier)



Connecting to an Audio System (5.1 Channel Amplifier)



Connecting to an Audio System (Dolby Digital, MPEG2 or DTS Amplifier)



Connecting to an Audio System (HDMI supported Amplifier)

Before Connecting the Blu-ray disc player

- Always turn off the Blu-ray disc player, TV and other components before you connect or disconnect any cables.
- Refer to the user's manual of additional components (such as a TV) you are connecting for more information on those particular components.

TV Output Selection Feature

You may choose from VIDEO, S-VIDEO, COMPONENT and HDMI mode for video output.

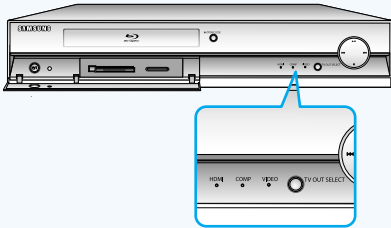

Use the **TV OUT SELECT** button on the front panel of the unit to select the video output while the disc is stopped.

- Video Output mode changes as follows when the **TV OUT SELECT** button is pressed: **HDMI → VIDEO → COMP → HDMI** order.
- To select HDMI output, press the **TV OUT SELECT** button until the **HDMI** indicator lights.
- To select COMPONENT output, press the **TV OUT SELECT** button until the **COMP** indicator lights.
- To select VIDEO or S-VIDEO output, press the **TV OUT SELECT** button until the **VIDEO** indicator lights.



NOTE

- If HDMI mode is selected for TVs providing display information (EDID), the TV resolution will be automatically changed to the best quality supported by the TV.
- If HDMI mode is selected for TVs that do not provide display information (EDID), resolution will be adjusted to 720p.
- If COMP (Component) mode is selected, resolution will be adjusted to 480p.
- If VIDEO mode is selected, resolution will be adjusted to 480i.
- Only resolutions supported by the TV are available.
- Select the resolution from <Setup> → <Display Setup>. (See page 43.)

Choosing a Connection

The following shows examples of connections commonly used to connect the Blu-ray disc player with a TV and other components.

Connecting to a TV(Video)

1. Using video/audio cables, connect the **VIDEO (yellow)/AUDIO (red and white) OUT** terminals on the rear of the Blu-ray disc player to the **VIDEO (yellow) /AUDIO (red and white) IN** terminals of your TV.
2. Turn on the Blu-ray disc player and TV.
3. Press the **TV OUT SELECT** button on the front panel of the unit until the **VIDEO** indicator lights. Make sure the unit is in Stop mode.
4. Press the input selector on your TV remote control until the Video signal from the Blu-ray disc player appears on the TV screen.
 - If you have set the remote control to properly operate with your TV (pages 15~16), press the **INPUT SEL.** button on the remote control and select VIDEO as the external source of the TV.

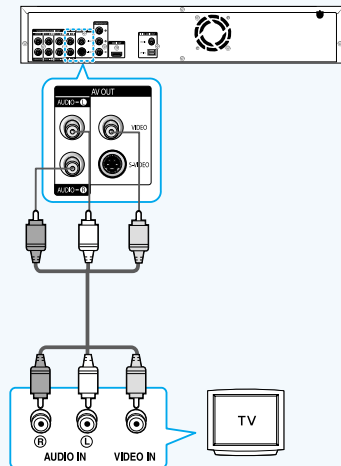

NOTE

- **Noise may be generated if the audio cable placed too close to the power cable.**
- If you want to connect to an Amplifier, please refer to the Amplifier connection page. (See pages 21 to 22)
- The number and position of terminals may vary depending on your TV set. Please refer to the user's manual of your TV.
- If there is one audio input terminal on the TV, connect it to the [AUDIO OUT][left] (white) terminal of the Blu-ray disc player.
- If you set the TV Out Select to HDMI, the Video/S-Video and Component Out terminals will not output any signal.
- Blu-ray Disc Playback is not available with this connection.

Connecting to a TV (S-Video)

- Connecting to your TV using an S-Video cable.
- You will enjoy high quality images. S-Video separates the picture element into black and white(Y) and color(C) signals to present clearer images than regular video input mode.
(Audio signals are delivered through the audio output.)

1. Using an S-Video cable (not included), connect the **S-VIDEO OUT** terminal on the rear of the Blu-ray disc player to the **S-VIDEO IN** terminal of your TV.
2. Using the audio cables, connect the **AUDIO (red and white) OUT** terminals on the rear of the Blu-ray disc player to the **AUDIO (red and white) IN** terminals of your TV. Turn on the Blu-ray disc player and TV.
3. Press the **TV OUT SELECT** button on the front panel of the unit until the **VIDEO** indicator lights. Make sure the unit is in Stop mode.
4. Press the input selector on your TV remote control until the S-Video signal from the Blu-ray disc player appears on your TV screen.
 - If you have set the remote control to properly operate with your TV (pages 15~16), press the **INPUT SEL.** button on the remote control and select S-VIDEO as the external source of the TV.

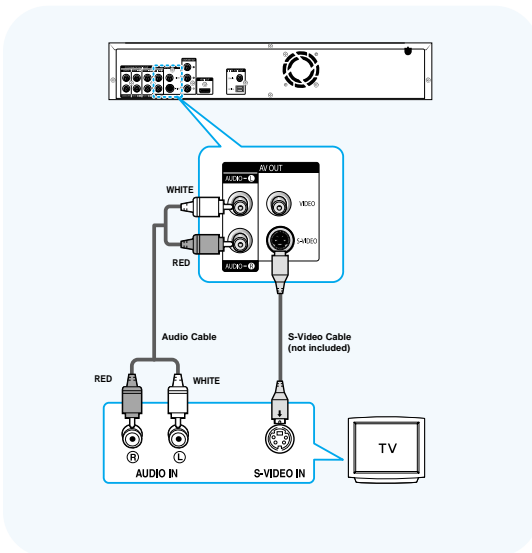

NOTE

- Blu-ray Disc Playback is not available with this connection.

Connecting to a TV (Component)

- Connecting to your TV using Component video cables.
- You will enjoy high quality and accurate color reproduction images. Component video separates the picture element into black and white(Y), blue(PB), red(PR) signals to present clear and clean images.
(Audio signals are delivered through the audio output.)

1. Using component video cables, connect the **COMPONENT VIDEO OUT** terminals on the rear of the Blu-ray disc player to the **COMPONENT IN** terminals of your TV.
2. Using the audio cables, connect the **AUDIO (red and white) OUT** terminals on the rear of the Blu-ray disc player to the **AUDIO (red and white) IN** terminals of your TV. Turn on the Blu-ray disc player and TV.
3. Press the **TV OUT SELECT** button on the front panel of the unit until the **COMP** indicator lights. Make sure the unit is in Stop mode.
4. Press the input selector on your TV remote control until the Component signal from the Blu-ray disc player appears on the TV screen.
 - If you have set the remote control to properly operate with your TV (pages 15~16), press the **INPUT SEL.** button on the remote control and select COMPONENT as the external source of the TV.

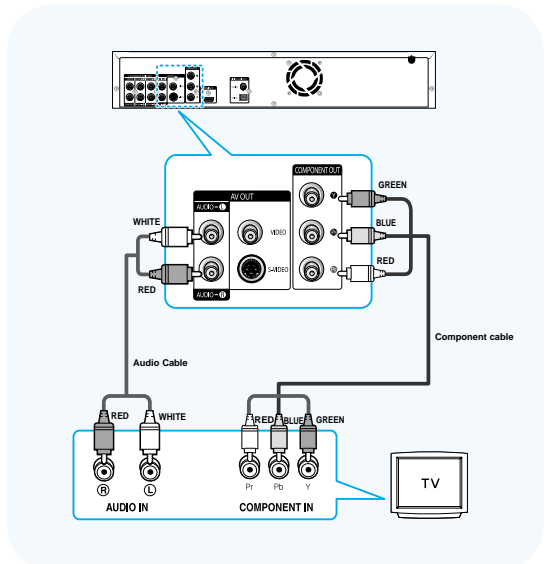

NOTE

- The component terminals on your TV may be marked "R-Y, B-Y, Y" or "Cr, Cb, Y" instead of "PR, PB, Y" depending on the manufacturer. The number and position of terminals may vary depending on the TV set. Please refer to the user's manual of your TV.
- Blu-ray Disc Playback is available with this connection in 720p or 1080i resolution.

Connecting to a TV with DVI Cable

- Using the HDMI-DVI cable, connect the **HDMI OUT** terminal on the rear of the Blu-ray disc player to the **DVI IN** terminal of your TV.
- Using the audio cables, connect the **AUDIO (red and white) OUT** terminals on the rear of the Blu-ray disc player to the **AUDIO (red and white) IN** terminals of your TV.
Turn on the Blu-ray disc player and TV.
- Press the **TV OUT SELECT** button on the front panel of the unit until the **HDMI** indicator lights. Make sure the unit is in Stop mode.
- Press the input selector on your TV remote control until the DVI signal from the Blu-ray disc player appears on your TV screen.
 - If you have set the remote control to properly operate with your TV (pages 15~16), press the **INPUT SEL.** button on the remote control and select HDMI as the external source of the TV.

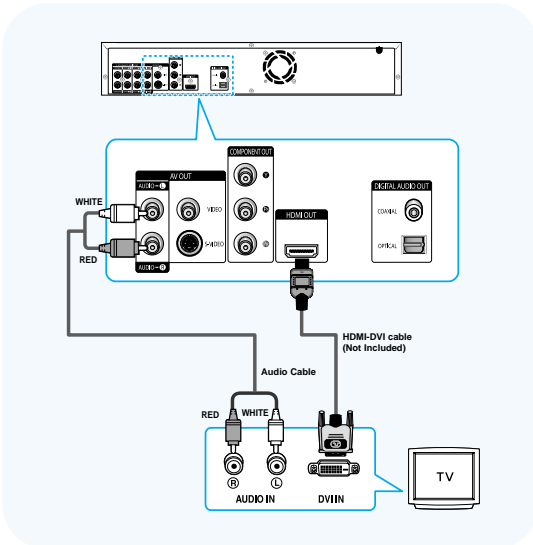

NOTE

- Blu-ray Disc Playback is available with this connection in 720p or 1080i or 1080p resolution

Connecting to a TV with HDMI Cable

- Using the HDMI-HDMI cable connect the **HDMI OUT** terminal on the rear of the Blu-ray disc player to the **HDMI IN** terminal of your TV.
- Press the **TV OUT SELECT** button on the front panel of the unit until the **HDMI** indicator lights. Make sure the unit is in Stop mode.
- Press the input selector on your TV remote control until the HDMI signal from the Blu-ray disc player appears on your TV screen.
 - If you have set the remote control to properly operate with your TV (pages 15~16), press the **INPUT SEL.** button on the remote control and select HDMI as the external source of the TV.

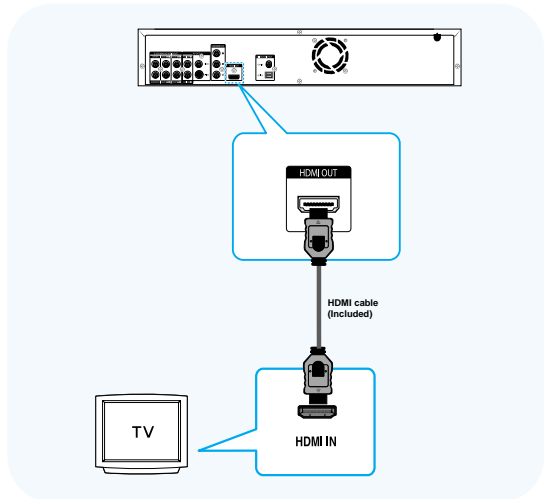

HDMI Auto Detection Function

Connecting the HDMI cable while the unit power is on, will automatically change the video output mode to HDMI mode.



NOTE

- Depending on your TV, certain HDMI output resolutions may not work.
- Please refer to the user's manual of your TV.
- If an HDMI or HDMI-DVI cable is plugged into TV, the Blu-ray disc player's output is set to HDMI/DVI automatically about 10 seconds later.
- If Component and HDMI are both connected, HDMI mode is automatically selected. (If HDMI is connected in Component mode or video mode, the video output mode automatically switches to HDMI mode.)
- Blu-ray Disc Playback is available with this connection in 720p or 1080i or 1080p resolution

• HDMI (High Definition Multimedia Interface)

HDMI is an interface that enables the digital transmission of video and audio data with just a single connector.

Using HDMI, the Blu-ray disc player transmits a digital video and audio signal and displays a vivid picture on a TV having an HDMI input jack.

• HDMI connection description

HDMI connector - Supports video and digital audio data (LPCM or Bit Stream).

- HDMI outputs only a pure digital signal to the TV.
- If TV does not support HDCP (High-bandwidth Digital Content Protection), random noise appears on the screen.

• Why does Samsung use HDMI?

Analog TVs require an analog video/audio signal. However, when playing a BD/DVD, the data transmitted to a TV is digital. Therefore either a digital-to-analog converter (in the Blu-ray disc player) or an analog-to-digital converter (in the TV) is required. During this conversion, the picture quality is degraded due to noise and signal loss. HDMI technology is superior because it requires no D/A conversion and is a pure digital signal from the player to your TV.

• What is the HDCP?

HDCP (High-band width Digital Content Protection) is a system for protecting BD/DVD content outputted via HDMI from being copied. It provides a secure digital link between a video source (PC, DVD. etc) and a display device (TV, projector . etc). Content is encrypted at the source device to prevent unauthorized copies from being made.

Connecting to an Audio System (2 Channel Amplifier)

1. Using the audio cables, connect the **AUDIO (red and white) OUT** terminals on the rear of the Blu-ray disc player to the **AUDIO (red and white) IN** terminals of your Amplifier.
2. Using the video signal cable(s), connect the **VIDEO, S-VIDEO, COMPONENT** or **HDMI OUT** terminals on the rear of the Blu-ray disc player to the **VIDEO, S-VIDEO, COMPONENT** or **HDMI IN** terminal of your TV as described on pages 18 to 20.
3. Turn on the Blu-ray disc player, TV and Amplifier.
4. Press the input select button of the Amplifier to select **external input** in order to hear sound from the Blu-ray disc player. Refer to your Amplifier's user manual to set the Amplifier's audio input.

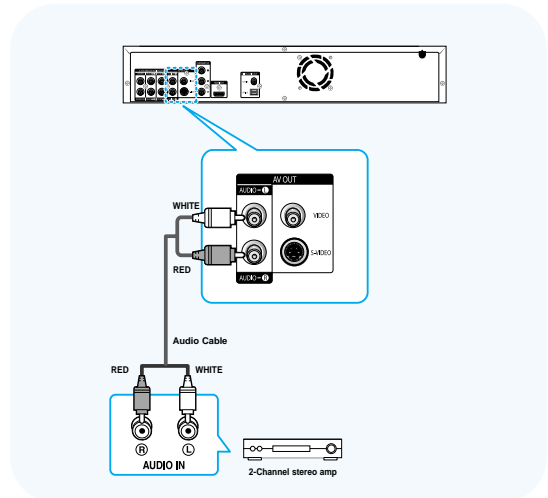

Manufactured under license from Dolby Laboratories. "Dolby" and the double-D symbol are trademarks of Dolby Laboratories.

"DTS" and "DTS DIGITAL SURROUND" are trademarks of DTS, Inc.

Connecting to an Audio System (5.1 Channel Amplifier)

- Using the audio cables, connect the **5.1 ANALOG AUDIO OUT (Front R, Front L, CENTER, SUBWOOFER, REAR L, REAR R)** terminals on the rear of the Blu-ray disc player to the **5.1 Channel ANALOG AUDIO IN (Front R, Front L, CENTER, SUBWOOFER, REAR L, REAR R)** terminals of your Amplifier.
- Using the video signal cable(s), connect the **VIDEO, S-VIDEO, COMPONENT** or **HDMI OUT** terminals on the rear of the Blu-ray disc player to the **VIDEO, S-VIDEO, COMPONENT** or **HDMI IN** terminal of your TV as described on pages 18 to 20
- Turn on the Blu-ray disc player, TV and Amplifier.
- Press the input select button of the Amplifier to select **external input** in order to hear sound from the Blu-ray disc player. Refer to your Amplifier's user manual to set the Amplifier's audio input.

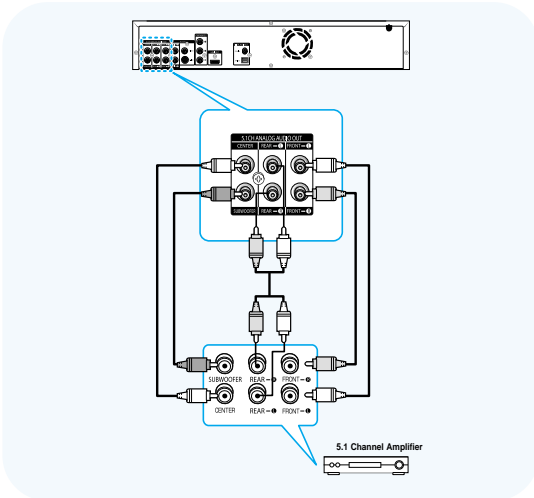

NOTE

- Please turn the volume down when you turn on the Amplifier. Sudden loud sound may cause damage to the speakers and your ears.
- Please set the audio in the menu screen according to the Amplifier. (See pages 40 to 41)
- The position of terminals may vary depending on the Amplifier. Please refer to the user's manual of your Amplifier.
- If you have the unit connected via the 5.1channel analog outputs and play a DVD Dolby Digital disc, sound will only be heard from the Front Left and Right speakers.
- If you have the unit connected via any analog output and play a DTS DVD disc, no sound will be heard. To hear sound, the digital output must be connected and set to Bitstream.

Connecting to an Audio System (Dolby Digital, MPEG2 or DTS Amplifier)

- If using an optical cable (not included), connect the **DIGITAL AUDIO OUT (OPTICAL)** terminal on the rear of the Blu-ray disc player to the **DIGITAL AUDIO IN (OPTICAL)** terminal of your Amplifier.
If using a coaxial cable (not included), connect the **DIGITAL AUDIO OUT (COAXIAL)** terminal on the rear of the Blu-ray disc player to the **DIGITAL AUDIO IN (COAXIAL)** terminal of the Amplifier.
- Using the video signal cable(s), connect the **VIDEO, S-VIDEO, COMPONENT** or **HDMI OUT** terminals on the rear of the Blu-ray disc player to the **VIDEO, S-VIDEO, COMPONENT** or **HDMI IN** terminals of your TV as described on pages 18 to 20.
- Turn on the Blu-ray disc player, TV, and Amplifier.
- Press the input select button of the Amplifier to select **external input** in order to hear sound from the Blu-ray disc player. Refer to your Amplifier's user manual to set the Amplifier's audio input.

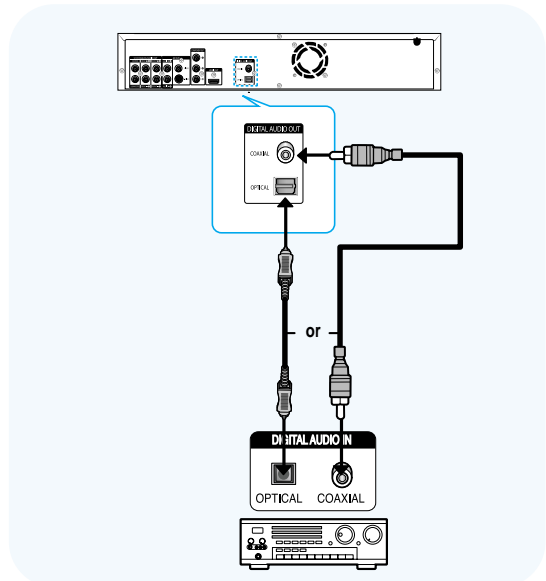



NOTE

- Please turn the volume down when you turn on the Amplifier. Sudden loud sound may cause damage to the speakers and your ears.
- Please set the audio in the menu screen according to the Amplifier. (See pages 40 to 41)
- The position of terminals may vary depending on the Amplifier. Please refer to the user's manual of your Amplifier.

Connecting to an Audio System (HDMI supported Amplifier)

1. Using the HDMI-HDMI cable, connect the **HDMI OUT** terminal on the rear of the Blu-ray disc player to the **HDMI IN** terminal of your Amplifier.
2. Using the HDMI-HDMI cable connect the **HDMI OUT** terminal of the Amplifier to the **HDMI IN** terminal of your TV.
3. Turn on the Blu-ray disc player, TV, and Amplifier.
4. Press the input select button of the Amplifier to select **external** input in order to hear sound from the Blu-ray disc player. Refer to your Amplifier's user manual to set the Amplifier's audio input.

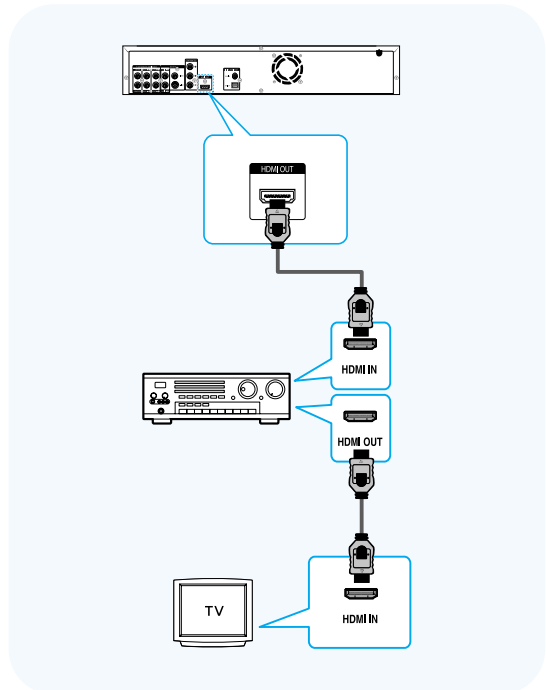

NOTE

- Please turn the volume down when you turn on the Amplifier. Sudden loud sound may cause damage to the speakers and your ears.
- Please set the audio in the menu screen according to the Amplifier. (See pages 40 to 41)
- The position of terminals may vary depending on the Amplifier. Please refer to the user's manual of your Amplifier.

Playback

This section introduces basic functions of playback and playback by disc type.

Before Playing	24
Playing a Disc.....	25
Using the Search & Skip Functions	26
Slow Motion Play/Step Motion Play	26
Using the Scene Search Function	27
Using the Display Function.....	28
Using the Disc Menu & Popup/Title Menu.....	28
Repeat Play	29
Selecting the Audio Language.....	30
Selecting the Subtitle Language.....	30
Changing the Camera Angle	31
Using the Bookmark Function	31
Playing an Audio CD/ MP3.....	33
Viewing a Picture.....	35
Using a Mixed disc (JPEG+MP3)	38

Before Playing

- Turn on your TV and set it to the correct Video Input on the TV's remote control.
- If you connected an external Audio System, turn on your Audio System and set it to the correct Audio Input.

After plugging in the player, the first time you press the POWER button, this screen comes up: If you want to select a language, press a NUMBER button. (This screen will only appear when you plug in the player for the first time.) If the language for the startup screen is not set, the settings may change whenever you turn the power on or off. Therefore, make sure that you select the language you want to use. Once you select a menu language, you can change it by pressing the ►► button on the front panel of the unit for more than 5 seconds with no disc in the unit. Then the MENU LANGUAGE SELECTION window appears again where you can reset your preferred language.



NOTE

- Discs which cannot be played and/or are not intended to be played with this player.
 - HD DVD • DVD+RW • DVD+R
 - CD-ROM • CVD
 - CD-I
 - Super Audio CD(except CD layer)
 - CDGs play audio only, not graphics.
- Ability to play back may depend on recording conditions.
 - DVD-R
 - CD-RW
 - DVD-RW (V mode)
 - The unit may not play certain CD-R, CD-RW and DVD-R due to the disc type or recording conditions.
- Blu-ray Disc is a new and evolving format. Accordingly, disc compatibility issues with new and existing format discs are possible. Not all discs are compatible and not every disc will playback. For additional information, also refer to the Disc Type and Characteristics and Compliance and Compatibility Notice sections of this Manual. If you encounter compatibility problems, please contact SAMSUNG customer care center.

Playing a Disc

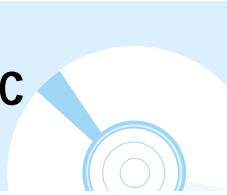

Playback

- 1 Press the **OPEN/CLOSE** (⏏) button.
The **STANDBY** indicator light goes out and the tray opens.
- 2 Place a disc gently into the tray with the disc's label facing up.
- 3 Press the **PLAY/PAUSE** (⏮) button or **OPEN/CLOSE** (⏏) button to close the disc tray.



NOTE

- When you stop disc play, the player remembers where you stopped, so when you press **PLAY/PAUSE** (⏮) button again, it will pick up where you left off.
- Press the **STOP** (⏏) button twice during playback to disable the Resume function.
- To pause the playback, press the **PLAY/PAUSE** (⏮) button during playback. To resume, press the **PLAY/PAUSE** (⏮) button once again.
- If the player is left in the stop mode for more than 10 minutes without any user interface, a screen saver will appear on your TV. If the player is left in the screen saver mode for more than 20 minutes, the power will automatically turn off except during playback of an MP3 and/or JPEG. (Automatic Power-Off Function)
- If the player is left for about 5 minutes in pause mode, it will stop.

Reading the Memory Card

This product supports the following memory card types. Insert the memory card in the slot with the label facing upwards. (The memory card will not be read if the label is not facing up.)

- Memory cards that can be used in the left slot :
Compact Flash Card, Micro Drive
- Memory cards that can be used in the right slot :
Memory Stick, Memory Stick PRO, Memory Stick Duo, Memory Stick Pro Duo, Secure Digital, Multi Media, Mini SD, RS MMC
- Four card types, Memory Stick Duo, Memory Stick Pro Duo, Mini SD and RS MMC, must be used with an adapter. (Do not directly insert into the slot without an adapter.)

- 1 Press the **OPEN** part of the front cover of the unit to open.
 - Open the front cover and the memory slot will appear.
- 2 Insert the memory card containing music, pictures and other data, into the memory slot.
 - If both slots are loaded and Memory Card is selected, the left slot has priority.
 - If Memory Card is selected, then both slots are loaded, the memory card inserted first will be played.
- 3 Press the **MENU** button and then the **RED(A)** button to select the Memory Card mode (if a BD/DVD disc is in the unit, it must be stopped).
 - To toggle between Disc and Memory Card, press the **MENU** button, then the **RED(A)** button.

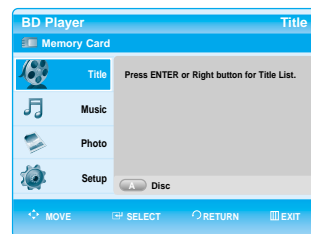

- 4 Select the folder you want to view or play.
 - MP3 : (see pages 33~35)
 - JPEG : (see pages 35~37)



Caution

- Do not remove the memory card while it is playing. This may cause data loss.
- Memory cards are only available for playback.



NOTE

- Repeat and random playback is available.

Using the Search and Skip Functions

During play, you can search quickly through a chapter or track, and use the skip function to jump to the next selection.

Searching through a Chapter or Track



During playback, press the **SEARCH** (⏪ ⏩) button.

- If you want to search at a faster speed on the BD/DVD, press this button.
- If you press the **SEARCH** (⏩) button,
▶▶ Fast 1 → ▶▶ Fast 2 → ▶▶ Fast 3
→ ▶▶ Fast 4 → ▶▶ Fast 5 → ▶▶ Fast 6
- If you press the **SEARCH** (⏪) button,
◀◀ Fast 1 → ◀◀ Fast 2 → ◀◀ Fast 3
→ ◀◀ Fast 4 → ◀◀ Fast 5 → ◀◀ Fast 6



NOTE

- The speed marked in this function may be different from the actual playback speed.
- No sound is heard during search mode.

Skipping Tracks



During playback, press the **SKIP** (⏮ ⏭) button.

When playing a BD/DVD, if you press the **SKIP** (⏭) button, it moves to the next chapter. If you press the **SKIP** (⏮) button, it moves to the beginning of the chapter. One more press makes it move to the beginning of the previous chapter.

Slow Motion Play/ Step Motion Play

Slow Motion Play



In pause or step mode, press the **SEARCH** (⏪ ⏩) button on the remote control for Slow Motion play.

- If you press the **SEARCH** (⏩) button,
▶ Slow 1 → ▶ Slow 2 → ▶ Slow 3
- If you press the **SEARCH** (⏪) button,
◀ Slow 1 → ◀ Slow 2 → ◀ Slow 3
- To return to normal speed playback, press the **PLAY/PAUSE** (⏸) button.



NOTE

- Using a BD-ROM/BD-RE, you can only perform slow motion play in the forward direction.
- This (⊘) icon indicates an invalid button press.
- No sound is heard during slow mode.

Step Motion Play



Press the **STEP** (⏮ ⏭) button on the remote control during play for Step Motion play.

- Each time the button is pressed a new frame will appear.
- When the step(⏭) button is pressed, the next frame will be activated.
- When the step(⏮) button is pressed, the previous frame will be activated.
- Press the **PLAY/PAUSE** (⏸) button to resume normal play.



NOTE

- Using a BD-ROM/BD-RE, you can only perform step motion play in the forward direction.
- No sound is heard during step mode.

Using the Scene Search Function

If search functions such as Actor, Character, Specific Scene and Special Search are provided in the BD disc, select the desired search criteria to easily search scenes.

Searching through a Scene



Ex) Searching by Actor

- 1 Press the **SCENE SEARCH** button during playback.
 - The Scene Search screen will appear.

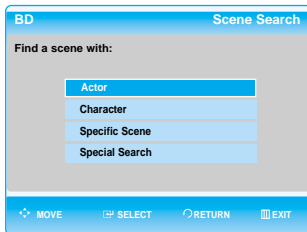

- 2 Press the **▲▼** button to select Actor, then press the **ENTER** button.
 - The Actor category screen will appear.

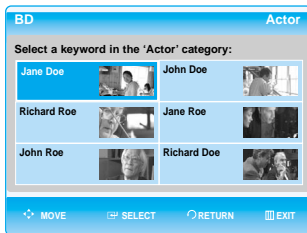

- 3 Press the **▲▼◀▶** button to select the desired Actor, and then press the **ENTER** button.
 - The selected Actor category screen will appear.

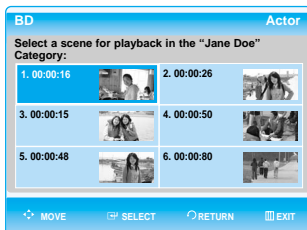

- 4 Press the **▲▼◀▶** button to select the desired scene, then press the **ENTER** button.
 - The selected scene will be played.



- 5 To play another scene of the selected Actor, press the **◀▶** button to select another scene, then press the **ENTER** button.



NOTE

- Depending on the disc, the Scene Search function may not be available.

Using the Display Function



- 1 During playback, press the **INFO** button on the remote control.
- 2 Press the **▲▼** buttons to select the desired item.

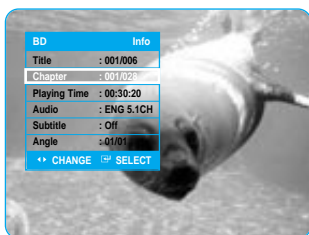

- 3 Press the **◀▶** buttons to make the desired setup and then press the **ENTER** button.
 - You may use the number buttons of the remote control to directly access a title, chapter or to start the playback from a desired time.
- 4 To make the screen disappear, press the **INFO** button again.



- If you are playing contents from the Info menu, playback may malfunction depending on the title.



NOTE

- **Title** : To access the desired title when there is more than one in the disc. For example, if there is more than one movie on a BD/DVD, each movie will be identified.
- **Chapter** : Most BD/DVD discs are recorded in chapters so that you can quickly find a specific passage.
- **Audio** : Refers to the film's soundtrack language. A BD disc can contain up to 32 audio languages and a DVD up to 8.
- **Time** : Allows playback of the film from a desired time. You must enter the starting time as a reference. The time search function does not operate on some discs.
- **Subtitle** : Refers to the subtitle languages available in the disc. You will be able to choose the subtitle languages or, if you prefer, turn them off from the screen. A BD disc can contain up to 255 subtitle languages, and a DVD up to 32.
- **Angle** : When a BD/DVD contains multiple angles of a particular scene, you can use the ANGLE function.

Using the Disc Menu & Popup/Title Menu

Using the Disc Menu



- 1 During playback, press the **DISC MENU** button on the remote control.
- 2 Press the **▲▼◀▶** buttons to make the desired setup, then press the **▶** or **ENTER** button.
 - The Disc menu setup items may vary from disc to disc.

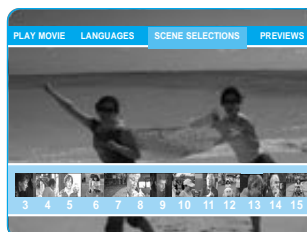

NOTE

- Depending on the disc, the Disc Menu may not be available.

Using the Title Menu



- 1 During playback, press the **TITLE MENU** button on the remote control.
- 2 Press the **▲▼◀▶** buttons to make the desired setup, then press the **ENTER** button.
 - The Title menu setup options may vary from disc to disc.



NOTE

- Depending on the disc, the Title Menu may not be available.
- Title Menu will only be displayed if there are at least two titles in the disc.

Using the Popup Menu



- 1 During playback, press the **POPUP MENU** button on the remote control.
- 2 Press the **▲▼◀▶** buttons or **ENTER** button to select the desired menu.
 - The Popup menu setup options may vary from disc to disc.

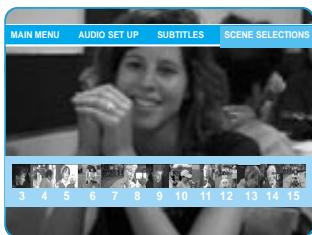

NOTE

- Depending on the disc, the Popup Menu may not be available.

Repeat Play



Repeat the current chapter or title.

Repeat playback



- 1 During playback, press the **REPEAT** button on the remote control.
Repeat screen appears.

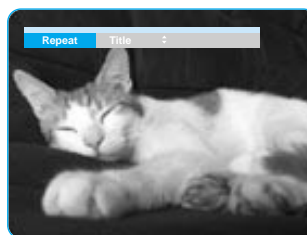

- 2 Press the **▲▼** buttons to select **Chapter** or **Title**.
 - BD/DVD repeats play by chapter or title.
- 3 To return to normal play, press the **REPEAT** button again, then press the **▲▼** buttons to select **Off**.



NOTE

- Depending on the disc, the Repeat function may not be available.

Using the A-B Repeat function



1. Press the **Repeat A-B** button on the remote control.
2. Press the **Repeat A-B** button at the point where you want repeat play to start (A).
3. Press the **Repeat A-B** button at the point where you want the repeat play to stop (B).
4. To return to normal play, press the **CANCEL** button.



NOTE

- Point B cannot be set until 5 seconds of playback has elapsed from point A.

Selecting the Audio Language

You can select a desired audio language quickly and easily with the AUDIO button.



Using the AUDIO button

- 1 Press the **AUDIO** button during playback. The Audio changes when the button is pressed repeatedly.
 - The audio languages are represented by abbreviations.



- 2 To remove the **AUDIO** icon, press the **CANCEL** or **RETURN** button.

<Using the INFO button>

1. During playback, press the **INFO** button on the remote control.
2. Press the **▲▼** buttons to select **Audio**.
3. Press the **◀▶** buttons on the remote control to select the desired audio.



NOTE

- This function depends on what audio languages are encoded on the disc and may not be available.
- A BD disc can contain up to 32 audio languages and a DVD up to 8.

Selecting the Subtitle Language

You can select a desired subtitle quickly and easily with the SUBTITLE button.



Using the SUBTITLE button

- 1 Press the **SUBTITLE** button. The subtitle changes when the button is pressed repeatedly. The subtitle languages are represented by abbreviations.



- 2 To remove the **SUBTITLE** icon, press the **CANCEL** or **RETURN** button.

<Using the INFO button>

1. During playback, press the **INFO** button on the remote control.
2. Press the **▲▼** buttons to select **Subtitle**.
3. Press the **◀▶** buttons on the remote control to select the desired subtitle language.



NOTE

- Depending on BD/DVDs, you have to change the desired subtitle in the Disc Menu. Press the **DISC MENU** button.
- This function depends on what subtitles are encoded on the disc and may not be available on all BD/DVDs.
- A BD disc can contain up to 255 subtitle languages and a DVD up to 32.

Changing the Camera Angle

When a BD/DVD contains multiple angles of a particular scene, you can use the ANGLE function.



Using the ANGLE function

1 During playback, press the **INFO** button on the remote control.

2 Press the **▲▼** buttons to select **Angle**.

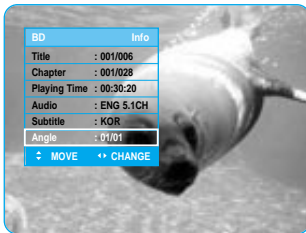

3 Press the **◀▶** buttons or you can use the number buttons on the remote control to select the desired angle.



NOTE

- If the disc has only one angle, this feature won't work. Currently, very few discs have this feature.
- Depending on the disc, these functions may not work.

Using the Bookmark Function

The features lets you bookmarks sections of a DVD so you can quickly find them at a later time.



Using the MARKER button

1 During playback, press the **MARKER** button on the remote control.

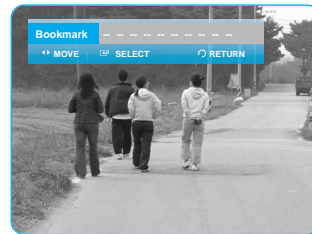

2 Press the **ENTER** button when the desired scene appears.

- The number **01** is displayed and the scene is memorized.

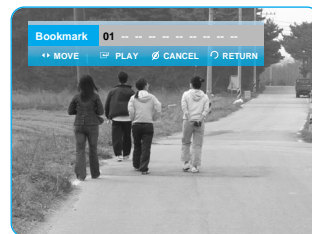

3 Press the **▶** buttons to move to the next position.

- 4** Press the **ENTER** button again when the desired scene appears.
The number **02** is displayed and the scene is memorized.

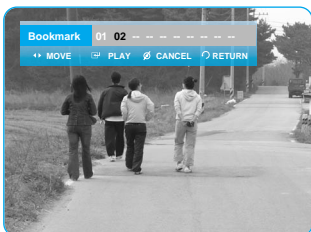

- Repeat above to bookmark other positions.
- You can bookmark up to 10 scenes.



NOTE

- When the disc tray is opened and then closed, bookmarks will disappear.

Playing back a bookmark



Using the MARKER button

- 1** During playback, press the **MARKER** button on the remote control.

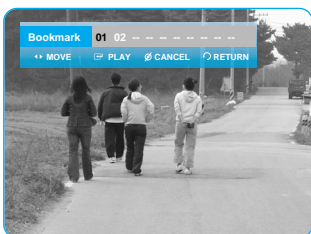

- 2** Press the **◀▶** buttons to select a bookmarked scene.

- 3** Press the **ENTER** or **PLAY/PAUSE** (⏮) button to start playing from the selected scene.

Clearing a bookmark



Using the MARKER button

- 1** During playback, press the **MARKER** button on the remote control.



- 2** Press the **◀▶** buttons to select a bookmarked scene.

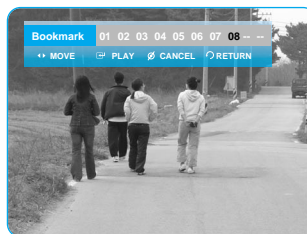

- 3** Press the **CANCEL** button to delete the selected bookmark.

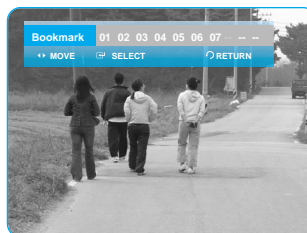

Playing an Audio CD/MP3

Playing an Audio CD(CD-DA)



- 1 Insert an audio CD (CD-DA) into the disc tray.
 - The Music List screen is displayed

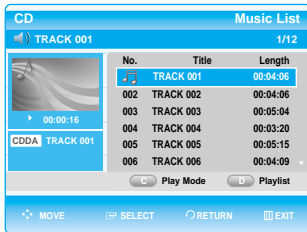

- 2 Press the ▲▼ buttons to select the track you want to play, and then press the ENTER button.

Playing an MP3



- 1 Insert an MP3 disc into the disc tray.
 - The Menu screen is displayed.
- 2 Press the ▲▼ buttons to select **Music**, then press the ENTER button.
 - The Music List is displayed.

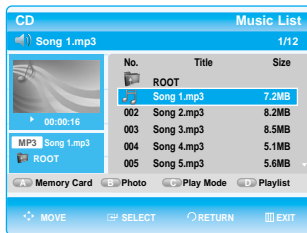

- 3 Press the ▲▼ buttons to select the MP3 file you want to play, and then press the ENTER button.

Audio CD(CD-DA)/MP3 Screen Elements

<Audio CD(CD-DA)>

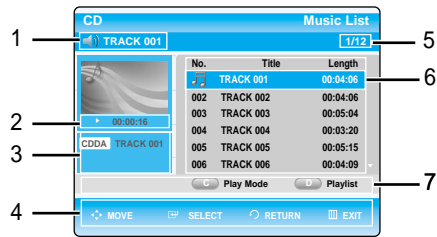

<MP3>



1. Current track (song): Displays the number of the track currently being played.
2. This shows the operating state of a disc and a playback time corresponding to a portion that is currently played.
3. Displays the current folder, current file type and file name.
4. Displays available buttons.
5. Displays the current play index, total track number.
6. Displays the track list (song list).
7. Display available COLOR buttons.
: RED(A), GREEN(B), YELLOW(C), BLUE(D)
8. Displays the media type. (Ex: CD, DVD, Memory Card)

Buttons on the Remote Control used for Audio CD(CD-DA)/ MP3 disc playback

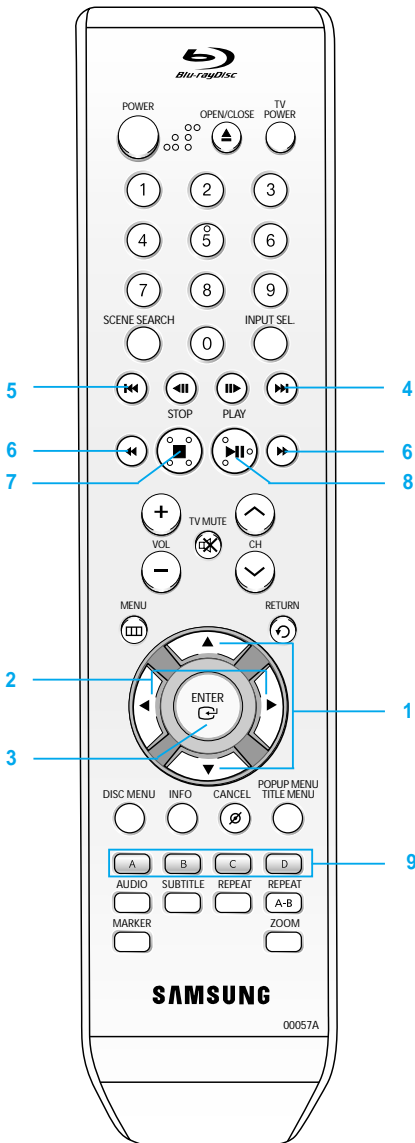

1. **▲▼ buttons** : Selects a track (song).
2. **◀▶ buttons**: Move the page up/down.
3. **ENTER button** : Plays the selected track (song).
4. **SKIP (⏭) button**: Plays the next track.
5. **SKIP (⏮) button**: Returns to the beginning of the current track when pressed during playback. If pressed again, your Blu-ray disc player moves to and plays the previous track.
If you press this button within three seconds after playback starts, the previous track will be played.
If you press this button after three seconds, the current track will be replayed from the beginning.
6. **Press the SEARCH (🔍) buttons**: Fast Play
7. **STOP (⏹) button**: Stops a track(song).
8. **PLAY/PAUSE (⏪) button**: Plays the currently selected track. If pressed during playback, the current track is paused.
9. **COLOR button**: The RED(A), GREEN(B), YELLOW(C) and BLUE(D) button is displayed.
 - RED(A) button : Selects the Memory Card.
 - GREEN(B) button : Selects the Photo Mode.
 - YELLOW(C) : Selects the Play Mode(Repeat).
 - BLUE(D) button : Go to Playlist.

Repeat CD (CD-DA) & MP3



Using the REPEAT button

During playback, press the **REPEAT** or **YELLOW(C)** button repeatedly to select the repeat mode you want.

When playing an Audio CD(CD-DA) :

Normal → → →

When playing an MP3 disc :

Normal → → →

- **Normal (CD (CD-DA)/MP3)**: Tracks on a disc are played in the order in which they were recorded on the disc.
- **Repeat Track (CD (CD-DA)/MP3)**
- **Repeat Folder (MP3)**
- **Random (CD (CD-DA)/MP3)**
 - **When playing an Audio CD(CD-DA)**: The random option plays a disc's track in random order.
 - **When playing an MP3 disc** : The random option plays a folder's file in random order.
- **Repeat All (CD-DA)**

- To return to normal playback -

Press the **REPEAT**, **YELLOW(C)** or **CANCEL** button repeatedly to return to normal playback.

Playlist

You can create a playlist with up to 30 tracks.

- 1 Press the **BLUE(D)** button during the Music List playback.

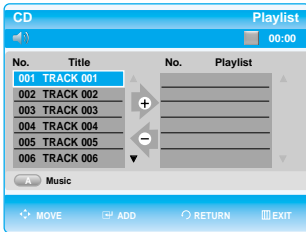

- 2 Press the **▲▼** buttons to select tracks in the order in which you want them to play, then press the **ENTER** button.

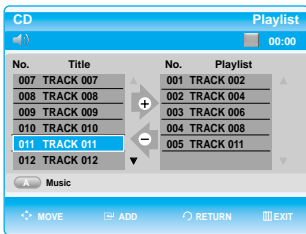

- 3 If there is a undesired track in the playlist, press the **▶▲▼** button to select that track, and then press the **CANCEL** button.
 - The selected track will be deleted.



- 4 Press the **▶▲▼** buttons to select the desired Track(song) you want to hear, then press the **ENTER** button.

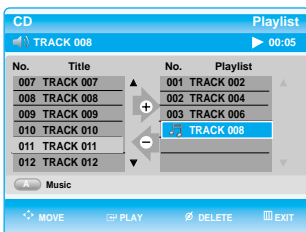

- 5 To go Music List, press the **RED(A)** button.

Viewing a Picture

Viewing a Picture



- 1 Insert a JPEG disc into the disc tray.
 - The Menu screen is displayed.

- 2 Press the **▲▼** buttons to select **Photo**, then press the **ENTER** button.
 - The Photo List is displayed.

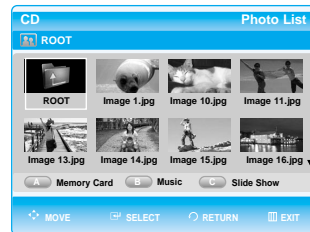

- 3 Press the **▲▼◀▶** buttons to select a picture.
 - To see the next 8 pictures, press the **SKIP (⊕)** button.
 - To see the previous 8 pictures, press the **SKIP (⊖)** button.

Slide Show



Using the **YELLOW(C)** button

To setup follow steps 1 and 2 above.

- 3 Press the **YELLOW(C)** button.



- 4 Press the **▲▼** buttons to select the slideshow speed (Fast, Normal, Slow), then press the **ENTER** button.
 - The Slide Show starts and plays at the selected speed.

- To stop the Slide Show -

Press the **STOP** or **RETURN** button.

<Using the INFO button>

1 Press the **ENTER** button to select the picture you want to see, then press the **INFO** button.

2 Press the **▲▼** buttons to select Slide Show.

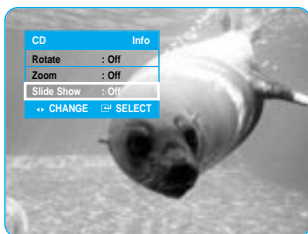

3 Press the **◀▶** buttons to select the Slide Show speed, then press the **ENTER** button.

- The Slide Show starts and plays at the selected speed.

- To stop the Slide Show -

1 Press the **INFO** button.

2 Press the **▲▼** buttons to select **Slide Show**.

3 Press the **◀▶** buttons to select the **Slide Show Off**, then press the **ENTER** button.



NOTE

- You can also play the Slide Show with PLAY button in the Photolist.
- JPEG's smaller than 1920 x 1080 will be displayed at normal resolution. They will not fully fill the screen.

Rotate

To setup, follow steps 1 to 2 in "Viewing a Picture" on page 35.

3-1 Press the **ENTER** button to select the picture you want to see, then press the **INFO** button.

4 Press the **▲▼** buttons to select **Rotate**.

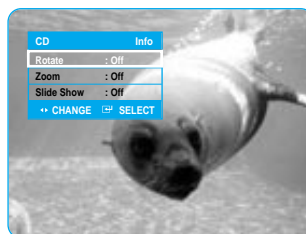

5 Press the **◀▶** buttons to select the rotate angle, then press the **ENTER** button.

- To stop the Rotate -

1 Press the **INFO** button.

2 Press the **▲▼** buttons to select **Rotate**.

3 Press the **◀▶** buttons to select **Rotate Off**, then press the **ENTER** button.

Zoom

To setup, follow steps 1 to 2 in "Viewing a Picture" on page 35.

- 3-1 Press the **ENTER** button to select the picture you want to see, then press the **INFO** button.

- 4 Press the **▲▼** buttons to select **Zoom**, then press the **◀▶** buttons to select **Zoom On**.

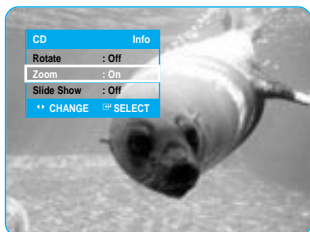

- 5 Each time the **ENTER** button is pressed, the picture is enlarged up to 4x(four times the normal size).

Zoom X2 → Zoom X4 → Zoom X2 → Normal

- To stop the Zoom -

- 1 Press the **INFO** button.
- 2 Press the **▲▼** buttons to select **Zoom Off**, then press the **ENTER** button.

Move Photo/Go To Photo List

To setup, follow steps 1 to 2 in "Viewing a Picture" on page 35.

- 3-1 Press the **ENTER** button to select the picture you want to see.

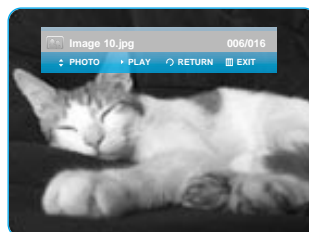

- 4 Press the **▲▼** buttons to move the previous or next picture.

- 5 To go Photo List, press the **RETURN** or **STOP** button.

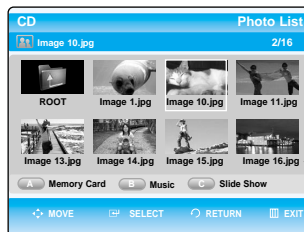

Using a Mixed disc (JPEG+MP3)



Example: Playing MP3 music

- 1 Insert a Mixed disc(JPEG+MP3) into the disc tray.
 - The Menu screen is displayed.
- 2 Press the ▲▼ buttons to select **Music**, then press the ENTER button.
 - The Music List is displayed.

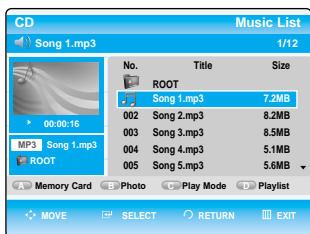

- 3 Press the ▲▼ buttons to select the MP3 file you want to play, and then press the ENTER button.

- To go to the Photo List -

Press the GREEN(B) button.

- You can go to the Photo List screen.

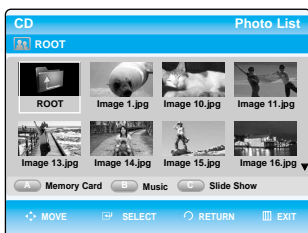

Example: Viewing JPEG pictures

- 1 Insert a Mixed disc(JPEG+MP3) into the disc tray.
 - The Menu screen is displayed.
- 2 Press the ▲▼ buttons to select **Photo**, then press the ENTER button.
 - The Photo List is displayed.

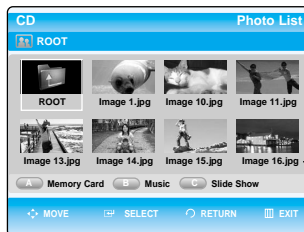

- 3 Press the ▲▼◀▶ buttons to select a picture.

- To go to the Music List -

Press the GREEN(B) button.

- You can go to the Music List screen.

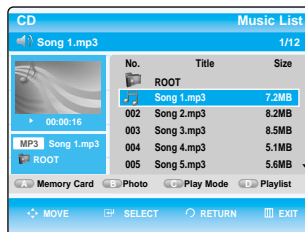

System Setup

On-Screen Menu Navigation

The on-screen menus allow you to enable or disable various functions on your Blu-ray disc player. Use the following buttons to open and navigate through the on-screen menus.

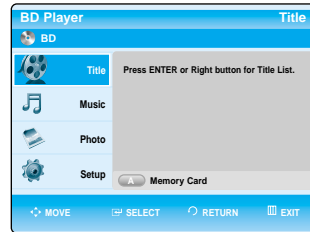

1 MENU Button

Press this button on the remote control to open the on-screen menu.
Press again to exit the on-screen menu.

2 ▲▼◀▶ Buttons

Press these buttons on the remote control to move the selection bar ▲▼◀▶ to cycle through the menu options.

3 ENTER Button

Press this button on the remote control to confirm any new settings.

4 RETURN Button

Press this button on the remote control to return to the Previous menu screen displayed or to exit the on-screen menu.

On-Screen Menu Navigation	39
Setting up the Language Options	40
Setting up the Audio Options	40
Setting up the Speaker Options	41
Setting up the Video display/output Options	42
Setting up the Parental Lock	44

Setting up the Language Options

If you set the audio, subtitle, disc menu and player menu, in advance, they will come up automatically every time you watch a movie.

1 With the unit in Stop mode, press the **MENU** button.

2 Press the **▲▼** buttons to select **Setup**, then press the **ENTER** or **▶** button.

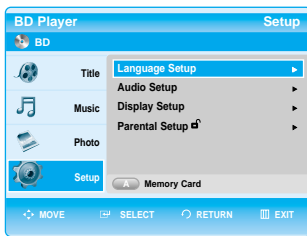

3 Press the **▲▼** buttons to select **Language Setup**, then press the **ENTER** or **▶** button. Language setup menu will be displayed.



4 Press the **▲▼** buttons to select the desired language option, press the **ENTER** or **▶** button.



- **Audio** : For the disc audio language.
- **Subtitle** : For the disc subtitles.
- **Disc Menu**: For the disc menu contained on the disc
- **Player Menu**: For the on-screen menu of your Blu-ray disc player.

5 Press the **▲▼** buttons to select the desired language, then press the **ENTER** button.



NOTE

- Press the **RETURN** or **◀** button to return to the previous menu. Press the **MENU** button to exit the menu.
- The selected language will only appear if it is supported on the disc.

Setting up the Audio Options

Allows you to setup the Audio device and sound status depending on the audio system in use.

1 With the unit in Stop mode, press the **MENU** button.

2 Press the **▲▼** buttons to select **Setup**, then press the **ENTER** or **▶** button.



3 Press the **▲▼** buttons to select **Audio Setup**, then press the **ENTER** or **▶** button.

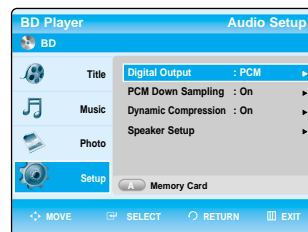

4 Press the ▲▼ buttons to select the desired audio option from the options described below, then press the **ENTER** or ► button.

5 Press the ▲▼ buttons to select the desired item, then press the **ENTER** button.



NOTE

- Press the **RETURN** or ◀ button to return to the previous menu.
Press the **MENU** button to exit the menu.

Digital Output

- **PCM** : Select this when your equipment does not decode Dolby Digital.
- **Bitstream** : Outputs Dolby Digital or MPEG-2 or DTS audio as bitstream. Select this when your AV receiver or AV amplifier has a Dolby Digital or MPEG-2 or DTS Decoder.



NOTE

- LPCM sound track is always outputted as PCM.
- Be sure to select the correct Digital Output or you will hear no sound or a loud noise.
- When playing a Dolby Digital movie make sure the Digital Output is set to Bitstream.
- If you have the unit connected via the 5.1 channel analog outputs and play a DVD Dolby Digital disc, sound will only be heard from the Front Left and Right speakers.
- If you have the unit connected via any analog output and play a DTS DVD disc, no sound will be heard. To hear sound, the digital output must be connected and set to Bitstream.

PCM Down Sampling

- **On** : Select this when the Amplifier connected to the player is not 96KHz compatible. In this case, the 96KHz signals will be down converted to 48KHz
- **Off** : Select this when the Amplifier connected to the player is 96KHz compatible. In this case, all signals will be output without any changes.



NOTE

- Even when PCM Down Sampling is set to Off, some discs will only output downsampled audio through the digital outputs.

HDMI

- If your TV is not compatible with compressed multi-channel formats (Dolby Digital, DTS, MPEG), you should set Digital Audio to PCM.
- If your TV is not compatible with LPCM sampling rates over 48kHz, you should set PCM Down Sampling to On.

Dynamic Compression

This is only active when a Dolby Digital signal is detected.

- **Off** : You can enjoy the movie with the standard Dynamic Range.
- **On** : When Movie soundtracks are played at low volume or from smaller speakers, the system can apply appropriate compression to make low-level content more intelligible and prevent dramatic passages from getting too loud.

Setting up the Speaker Options

1 With the unit in Stop mode, press the **MENU** button.

2 Press the ▲▼ buttons to select **Setup**, then press the **ENTER** or ► button.

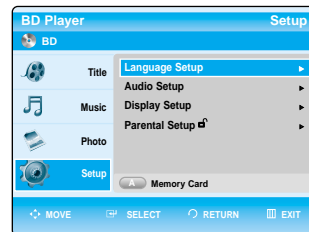

3 Press the ▲▼ buttons to select **Audio Setup**, then press the **ENTER** or ► button.

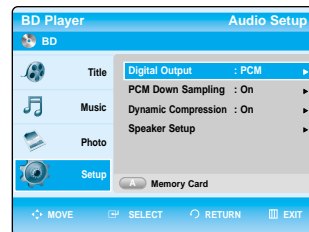

4 Press the ▲▼ buttons to select **Speaker Setup**, then press the **ENTER** or ► button.

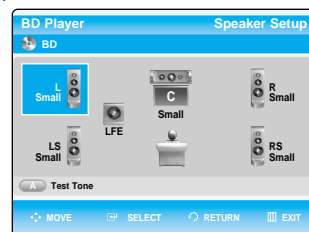

- 5** Press the **▲▼◀▶** buttons to select the desired Speaker, then press the **ENTER** button.



NOTE

- Press the **RETURN** or **◀** button to return to the previous menu.
- Press the **MENU** button to exit the menu.

Speaker Setup

Front (L,R)	Large, Small
Center (C)	Large, Small, Off
Surround (LS,RS)	Large, Small, Off
Subwoofer (SW)	LFE, Off

Speaker

- Large** : Delivers a full band sound from bass below 100 Hz.
- Small** : If LFE is on, bass below 100 Hz will outputted through Subwoofer instead of the speakers. If LFE is off and the Front Speaker is set to Large, sound will be outputted through the Front Speaker.
- Off** : Select to disable the speakers.

Subwoofer Speaker

- LFE** : Select to use the subwoofer speaker.
- Off** : Select to disable the subwoofer speaker. (This option can only be selected when the Front (L+R) speakers are set to Large.)

Press the RED(A) button

- A test tone will be sent to **L → C → R → RS → LS → LFE** in order.
- During test tone, press the **ENTER** button to setup the speaker. To end the test tone, press the **RED(A)** button again.

Setting up the Video display/output Options

This function allows you to setup the TV screen settings. This function depends on disc type. It may not work for some disc types.

- 1** With the unit in Stop mode, press the **MENU** button.

- 2** Press the **▲▼** buttons to select **Setup**, then press the **ENTER** or **▶** button.

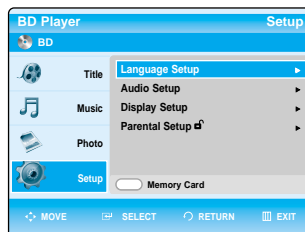

- 3** Press the **▲▼** buttons to select **Display Setup**, then press the **ENTER** or **▶** button. Video setup menu will be displayed.



- 4** Press the **▲▼** buttons to select the desired display option, then press the **ENTER** or **▶** button.

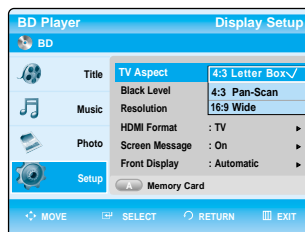

- 5** Press the **▲▼** buttons to select the desired item, then press the **ENTER** button.



NOTE

- Press the **RETURN** or **◀** button to return to the previous menu.
- Press the **MENU** button to exit the menu.

TV Aspect

Depending on the type of television you have, you may want to adjust the screen setting. (aspect ratio)

- **4:3 Letter Box:**
Select when you want to see the total 16:9 ratio screen BD/DVD supplies, even though you have a TV with a 4:3 ratio screen. Black bars will appear at the top and bottom of the screen.
- **4:3 Pan-Scan :**
Select this for conventional size TV when you want to see the central portion of the 16:9 screen. (Extreme left and right side of movie picture will be cut off.)
- **16:9 Wide :**
You can view the full 16:9 picture on your widescreen TV.

Black Level

Adjusts the screen brightness of the video signal.

- **On :** Select to increase the black level of the picture.
- **Off :** Select for the standard black level.

Resolution

Sets the output resolution of the Component and HDMI video signal.

- Press the TV OUT SELECT button on the front panel of the unit to select the HDMI mode, and then select from 1080p, 1080i, 720p and 480p. Resolutions not supported by your TV are unavailable.
- Press the TV OUT SELECT button on the front panel of the unit to select the COMPONENT mode, and then select from 1080i, 720p, 480p and 480i. Resolutions are not supported by your TV are unavailable.
- Please refer to page 18 for more information on video output selection.
- The number in 480i, 480p, 720p, 1080p and 1080i indicates the number of lines of video. The i and p indicate interlace and progressive scan, respectively.
 - 1080p : Outputs 1080 lines of progressive video.
 - 1080i : Outputs 1080 lines of interlaced video.
 - 720p : Outputs 720 lines of progressive video.
 - 480p : Outputs 480 lines progressive video.
 - 480i : Outputs 480 lines of interlaced video. 480i resolution is not available for HDMI output.



NOTE

- Blu-ray Disc playback is available with only HD mode (720p, 1080i and 1080p)

Resolution output according to disc type

In HDMI mode

BD playback : 1080p, 1080i, 720p are available.
DVD playback : 1080p, 1080i, 720p and 480p are all available.
However, resolutions not supported by the TV are unavailable.

In COMPONENT mode

- **BD playback**
Manufacturers of Blu-ray Discs may restrict access to certain video outputs and resolutions. These constraints are referred to as "Tokens". There are three different levels of permission possible, they are:
 - Token Disable : 1080p, 1080i, 720p are available.
 - ICT Enable or DOT Enable : Component and all analog outputs are disabled in this token. HDMI must be connected to view a disc with this token.
- **DVD playback**
Only 480p and 480i are available. (1080i and 720p will be outputted as 480p even if selected.)

In VIDEO (S-VIDEO) mode

BD playback is not available in this mode.
DVD playback: Cannot change resolution in VIDEO mode and only 480i output is available.

Discs	HDMI mode (HDMI output)	Component mode (Component output)	Video mode(S-Video, Video output)
Blu-ray Disc	1080p, 1080i, 720p	1080i, 720p	No picture
Blu-ray Disc with ICT (Image Constraint Token)		No picture	No picture
Blu-ray Disc with DOT (Digital Only Token)		No picture	No picture
DVD	1080p, 1080i, 720p, 480p	480p, 480i	480i

HDMI Format

You can choose from TV or Monitor for HDMI output.

- **TV :** Select if HDMI output is connected to the TV.
- **Monitor :** Select if HDMI output is connected to the Monitor.

If the player is connected to a TV, the Monitor option is unavailable.

Screen Message

- **On :** Displays messages related to operation mode.
- **Off :** Does not display messages related to operation mode.

Front Display

- **Automatic :** Display is dark during playback and bright when the unit is in Stop mode.
- **Dim :** Select to dim the display window.
- **Bright :** Select to brighten the display window.

Setting up the Parental Lock

The Parental Lock function works in conjunction with BD/DVDs that have been assigned a rating which helps you control the types of BD/DVDs that your family watches. There are up to 8 rating levels on a disc.



- 1 With the unit in Stop mode, press the **MENU** button.
- 2 Press the **▲▼** buttons to select **Setup**, then press the **ENTER** or **▶** button.
 
- 3 Press the **▲▼** buttons to select **Parental Setup**, then press the **ENTER** or **▶** button. When you operate your Blu-ray disc player for the first time, the “Enter New password” message will be displayed.

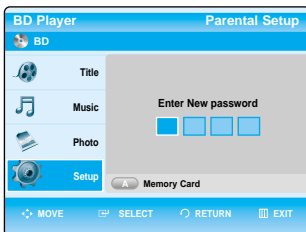

- 4 Enter the 4-digit password using the number buttons on the remote control. The “Confirm the password” message will be displayed. Enter your password again.

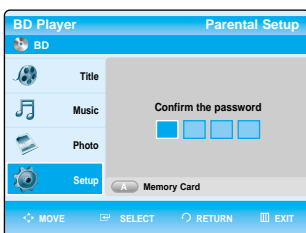

- 5 Press the **ENTER** or **▶** button to select **Use Password**.

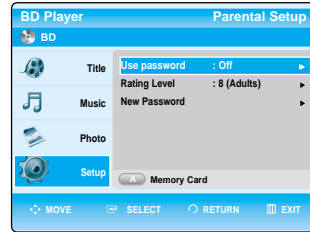

- 6 Press the **▲▼** buttons to select **On** or **Off**, then press the **ENTER** button.



- Press the **RETURN** or **◀** button to return to the previous menu. Press the **MENU** button to exit the menu.

If you forgot your password

- 1 Remove the disc.
- 2 Press and hold the **▶▶** button on the front panel for 5 seconds or more.
 - All settings will revert to the factory settings.

Setting the Rating Level

- 1 Press the ▲▼ buttons to select **Rating Level**, then press the ENTER or ► button.

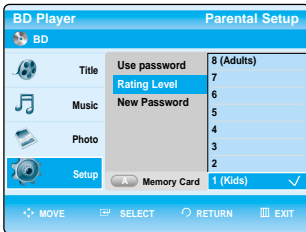

- 2 Press the ▲▼ buttons to select the rating level you want, then press the ENTER button. For example, if you select up to Level 6, discs that contain Level 7, 8 will not play. A larger number indicates that the program is intended for adult use only.

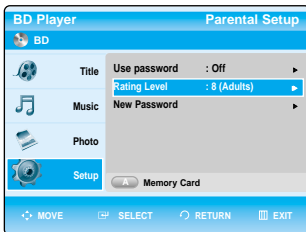

Changing the Password

- 1 Press the ▲▼ buttons to select **New Password**, then press the ENTER or ► button.

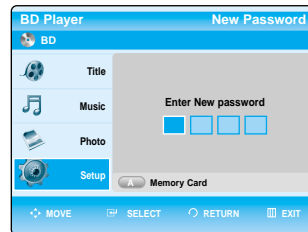
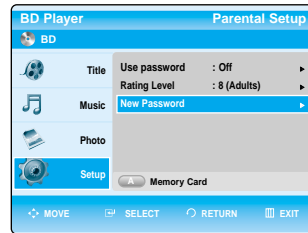

- 2 Enter the 4-digit password using the number buttons on the remote control. The “Confirm the password” message will be displayed.



- 3 Enter your password again using the number buttons on the remote control.

Reference

Troubleshooting46
Specifications48

Troubleshooting

Before requesting service (troubleshooting), please check the following.

No operations can be performed with the remote control.



- Check the batteries in the remote control. They may need replacing.
- Operate the remote control at a distance of no more than 20 feet.
- Remove batteries and hold down one or more buttons for several minutes to drain the microprocessor inside the remote control to reset it. Reinstall batteries and try to operate the remote control again.

Disc does not play.



- Ensure that the disc is installed with the label side facing up.
- Check the region number of the BD/DVD.

5.1 channel sound is not being reproduced.



- 5.1 channel sound is reproduced only when the following conditions are met. :
 1. The Blu-ray disc player is connected with the proper Amplifier
 2. The disc is recorded with 5.1 channel sound.
- Check whether the disc being played has the "5.1 ch" mark on the outside.
- Check if your audio system is connected and working properly.
- In a SETUP Menu, is the Audio Output set to Bitstream?

Disc Menu doesn't appear.



- Check if the disc has a Menu.

The  icon appears on screen.



- The features or action cannot be completed at this time because:
 1. The BD/DVD's software restricts it.
 2. The BD/DVD's software doesn't support the feature (e.g., angles)
 3. The feature is not available at the moment.
 4. You've requested a title or chapter number or search time that is out of range.

Play mode differs from the Setup Menu selection.



- Some of the functions selected in the Setup Menu may not work properly if the disc is not encoded with the corresponding function.

The screen ratio cannot be changed.



- The Screen Ratio is fixed on your BD/DVDs.

No audio.



- Make sure you have selected the correct Digital Output in the Audio Options Menu.

The screen is blocked



- Press the  button (in front panel) for more than 5 seconds with no disc inside. All settings will revert to the factory settings.
- Check video output mode.

Forgot password



- Press the  button (in front panel) for more than 5 seconds with no disc inside. All settings including the password will revert to the factory settings. Don't use this unless absolutely necessary.

If you experience other problems.



- Go to the contents and find the section of the instruction book that contains the explanations regarding the current problem, and follow the procedure once again.
- If the problem still cannot be solved, please contact your nearest Samsung authorized service center.

The picture is noisy or distorted



- Make sure that the disc is not dirty or scratched.
- Clean the disc.

No HDMI output.



- Check the Video output is set to HDMI.
- Check the connection between the TV and the HDMI jack of Blu-ray disc player.
- Check if your TV supports 480p/720p/1080i/1080p HDMI input resolution.

Abnormal HDMI output screen.



- If random noise appears on the screen, it means that TV does not support HDCP (High-bandwidth Digital Content Protection).

Specifications



General	Power Requirements	AC 120V ~ 60Hz
	Power Consumption	51 W
	Weight	9.3 lbs
	Dimensions	16.9 (W) x 12.8 (D) x 3.1 (H) inches
	Operating Temperature Range	+ 41° F to +95° F
	Operating Humidity Range	10 % to 75 %
Disc	BD (Blu-ray Disc)	Reading Speed : 4.917m/sec
	DVD (Digital Versatile Disc)	Reading Speed : 3.49 ~ 4.06 m/sec.
		Approx. Play Time (Single Sided, Single Layer Disc) : 135 min.
	CD : 12cm (COMPACT DISC)	Reading Speed : 4.8 ~ 5.6 m/sec.
		Maximum Play Time : 74 min.
	CD : 8cm (COMPACT DISC)	Reading Speed : 4.8 ~ 5.6 m/sec.
Maximum Play Time : 20 min.		
Video Output	Composite Video	1 channel : 1.0 Vp-p (75 Ω load)
		Blu-ray Disc : Not available DVD : 480i
	Component Video	Y : 1.0 Vp-p (75 Ω load)
		Pr : 0.70 Vp-p (75 Ω load)
		Pb : 0.70 Vp-p (75 Ω load)
		Blu-ray Disc : 1080i, 720p DVD : 480p, 480i
	S-Video	Luminance Signal : 1.0 Vp-p (75 Ω load)
		Chrominance Signal : 0.3 Vp-p (75 Ω load)
		Blu-ray Disc : Not available DVD : 480i
	Video/Audio	HDMI
PCM multichannel audio, bitstream audio, PCM audio		
Audio Output	2 Channel	L(1/L), R(2/R)
	5.1 Channel	F/L, F/R, R/L, R/R, C/T, S/W
	Digital Audio Output	Optical/Coaxial
	*Frequency Response	48 kHz Sampling : 4 Hz to 22 kHz
		96 kHz Sampling : 4 Hz to 44 kHz
	*S/N Ratio	110 dB
	*Dynamic Range	100 dB
*Total Harmonic Distortion	0.004%	

*: Nominal specification

- Samsung Electronics Co., Ltd reserves the right to change the specifications without notice.
- Weight and dimensions are approximate.

Warranty (for USA users only)

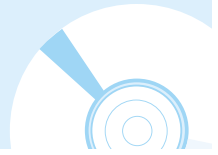

LIMITED WARRANTY TO ORIGINAL PURCHASER

This SAMSUNG brand product, as supplied and distributed by SAMSUNG ELECTRONICS AMERICA, INC. (SAMSUNG) and delivered new, in the original carton to the original consumer purchaser, is warranted by SAMSUNG against manufacturing defects in materials and workmanship for the following limited warranty period:

One (1) Year Parts / Ninety Days (90) Labor

This limited warranty begins on the original date of purchase, and is valid only on products purchased and used in the United States, and does not include transportation, installation, removal or reinstallation. Warranty repairs must be performed by SAMSUNG's authorized service center. To receive warranty service, the original dated bill of sale must be presented upon request as proof of purchase to SAMSUNG or SAMSUNG's authorized service center. Transportation to and from the service center is the responsibility of the purchaser.

SAMSUNG will repair or replace this product, at our option and at no charge with new or reconditioned parts, if found to be defective during the limited warranty period specified above. The product must be returned during the warranty period with transportation charges prepaid to SAMSUNG's designated service center. Prior to returning any product for warranty service, the purchaser must contact SAMSUNG for problem determination and service procedures. SAMSUNG does not warrant uninterrupted or error-free operation of the product. All replaced parts and products become the property of SAMSUNG and must be returned to SAMSUNG. Replacement parts and products assume the remaining original warranty, or ninety (90) days, whichever is longer.

This limited warranty covers manufacturing defects in materials and workmanship encountered in normal, noncommercial use of this product and shall not apply to the following, including, but not limited to: damage which occurs in shipment; applications and uses for which this product was not intended; failures or problems which are caused by products or equipment not supplied by SAMSUNG; accidents, misuse, abuse, neglect, misapplication, fire, water, lightning or other acts of nature; incorrect electrical line voltage, fluctuations or surges; damage caused by improper or faulty installation; improper connection with any peripheral; product alteration or modification; improper or unauthorized repair; cosmetic damage or exterior finish; product with altered serial numbers; failure to follow operating instructions, customer adjustments, maintenance and environmental instructions that are covered and prescribed in the instruction book; use of non-SAMSUNG or unauthorized parts, supplies, accessories or equipment which damage this product or result in service problems; failures or problems due to incompatibility with other equipment.

No person, agent, distributor, dealer or company is authorized to change, modify or extend the terms of these warranties in any manner whatsoever. The time within which an action must be commenced to enforce any obligations of SAMSUNG arising under the warranty or under any statute, or law of the United States or of any state thereof, is hereby limited to ninety (90) days from the date you discovered or should have discovered the defect. This limitation does not apply to implied warranties arising under state law, if any.

SAMSUNG does not warrant (i) disc compatibility with new and existing format discs or (ii) error free playback in full compliance with specifications of the compatible disc formats, and SAMSUNG shall not be liable for any data loss recorded in your discs.

SAMSUNG's responsibility shall be limited to appropriate warranty services during the warranty period through SAMSUNG customer care center. If you encounter compatibility or data loss problems, please contact SAMSUNG customer care center.

THERE ARE NO EXPRESS WARRANTIES OTHER THAN THOSE LISTED AND DESCRIBED ABOVE, AND NO WARRANTIES WHETHER EXPRESS OR IMPLIED, INCLUDING, BUT NOT LIMITED TO, ANY IMPLIED WARRANTIES OF MERCHANTABILITY OR FITNESS FOR A PARTICULAR PURPOSE, SHALL APPLY AFTER THE EXPRESS WARRANTY PERIODS STATED ABOVE, AND NO OTHER EXPRESS WARRANTY OR GUARANTEE GIVEN BY ANY PERSON, FIRM OR CORPORATION WITH RESPECT TO THIS PRODUCT SHALL BE BINDING ON SAMSUNG. SAMSUNG SHALL NOT BE LIABLE FOR LOSS OF REVENUE OR PROFITS, FAILURE TO REALIZE SAVINGS OR OTHER BENEFITS, OR ANY OTHER SPECIAL, INCIDENTAL OR CONSEQUENTIAL DAMAGES CAUSED BY THE USE, MISUSE OR INABILITY TO USE THIS PRODUCT, REGARDLESS OF THE LEGAL THEORY ON WHICH THE CLAIM IS BASED, AND EVEN IF SAMSUNG HAS BEEN ADVISED OF THE POSSIBILITY OF SUCH DAMAGES. NOR SHALL RECOVERY OF ANY KIND AGAINST SAMSUNG BE GREATER IN AMOUNT THAN THE PURCHASE PRICE OF THE PRODUCT SOLD BY SAMSUNG AND CAUSING THE ALLEGED DAMAGE. WITHOUT LIMITING THE FOREGOING, PURCHASER ASSUMES ALL RISK AND LIABILITY FOR LOSS, DAMAGE OR INJURY TO PURCHASER AND PURCHASER'S PROPERTY AND TO OTHERS AND THEIR PROPERTY ARISING OUT OF THE USE, MISUSE OR INABILITY TO USE THIS PRODUCT SOLD BY SAMSUNG NOT CAUSED DIRECTLY BY THE NEGLIGENCE OF SAMSUNG. THIS LIMITED WARRANTY SHALL NOT EXTEND TO ANYONE OTHER THAN THE ORIGINAL PURCHASER OF THIS PRODUCT, IS NONTRANSFERABLE AND STATES YOUR EXCLUSIVE REMEDY.

Some states do not allow limitations on how long an implied warranty lasts, or the exclusion or limitation of incidental or consequential damages, so the above limitations or exclusions may not apply to you. This warranty gives you specific legal rights, and you may also have other rights which vary from state to state.

To obtain warranty service, please contact SAMSUNG customer care center.

Contact SAMSUNG WORLD WIDE

Blu-ray Disc is a new and evolving format. Accordingly, disc compatibility issues with new and existing format discs are possible. Not all discs are compatible and not every disc will playback. For detailed information, please refer to the User's Manual, including the Disc Type and Characteristics and Compliance and Compatibility Notice sections of the User's manual. If you encounter compatibility problems, have any questions or comments relating to Samsung products, please contact the SAMSUNG customer care center.

Region	Country	Customer Care Center ☎	Web Site
North America	CANADA	1-800-SAMSUNG (7267864)	www.samsung.com/ca
	MEXICO	01-800-SAMSUNG (7267864)	www.samsung.com/mx
	U.S.A	1-800-SAMSUNG (7267864)	www.samsung.com
Latin America	ARGENTINE	0800-333-3733	www.samsung.com/ar
	BRAZIL	0800-124-421	www.samsung.com/br
	CHILE	800-726-7864(SAMSUNG)	www.samsung.com/cl
	COSTA RICA	0-800-507-7267	www.samsung.com/latin
	ECUADOR	1-800-10-7267	www.samsung.com/latin
	EL SALVADOR	800-6225	www.samsung.com/latin
	GUATEMALA	1-800-299-0013	www.samsung.com/latin
	JAMAICA	1-800-234-7267	www.samsung.com/latin
	PANAMA	800-7267	www.samsung.com/latin
	PUERTO RICO	1-800-682-3180	www.samsung.com/latin
	REP. DOMINICA	1-800-751-2676	www.samsung.com/latin
Europe	TRINIDAD & TOBAGO	1-800-7267-864	www.samsung.com/latin
	VENEZUELA	1-800-100-5303	www.samsung.com/latin
	BELGIUM	02 201 2418	www.samsung.com/be
	CZECH REPUBLIC	844 000 844	www.samsung.com/cz
	DENMARK	38 322 887	www.samsung.com/dk
	FINLAND	09 693 79 554	www.samsung.com/fi
	FRANCE	08 25 08 65 65 (0,15/Min)	www.samsung.com/fr
	GERMANY	01805 - 121213 (0,12/Min)	www.samsung.de
	HUNGARY	06 40 985 985	www.samsung.com/hu
	ITALIA	199 153 153	www.samsung.com/it
	LUXEMBURG	02 261 03 710	www.samsung.lu
	NETHERLANDS	0900 20 200 88 (0.10/Min)	www.samsung.com/nl
	NORWAY	231 627 22	www.samsung.com/no
	POLAND	0 801 801 881	www.samsung.com/pl
	PORTUGAL	80 8 200 128	www.samsung.com/pt
	SLOVAKIA	0850 123 989	www.samsung.com/sk
	SPAIN	902 10 11 30	www.samsung.com/es
SWEDEN	08 585 367 87	www.samsung.com/se	
U.K	0870 242 0303	www.samsung.com/uk	
CIS	RUSSIA	8-800-200-0400	www.samsung.ru
	UKRAINE	8-800-502-0000	www.samsung.com/ur
Asia Pacific	AUSTRALIA	1300 362 603	www.samsung.com/au
	CHINA	800-810-5858, 010- 6475 1880	www.samsung.com.cn
	HONG KONG	2862 6001	www.samsung.com/hk
	INDIA	3030 8282 1600 1100 11	www.samsung.com/in
	INDONESIA	0800-112-8888	www.samsung.com/id
	JAPAN	0120-327-527	www.samsung.com/jp
	MALAYSIA	1800-88-9999	www.samsung.com/my
	PHILIPPINES	1800-10-SAMSUNG (7267864)	www.samsung.com/ph
	SINGAPORE	1800-SAMSUNG (7267864)	www.samsung.com/sg
	THAILAND	1800-29-3232 02-689-3232	www.samsung.com/th
Middle East & Africa	TAIWAN	0800-329-999	www.samsung.com/tw
	VIETNAM	1 800 588 889	www.samsung.com/vn
	SOUTH AFRICA	0860 7267864 (SAMSUNG)	www.samsung.com/za
	U.A.E	800SAMSUNG (7267864)	www.samsung.com/mea