

User's Manual



DVS 204

Digital Video Scaler series

DVS 204, DVS 204 D, DVS 204 12V, DVS 204 D 12V

Precautions

Safety Instructions • English



This symbol is intended to alert the user of important operating and maintenance (servicing) instructions in the literature provided with the equipment.



This symbol is intended to alert the user of the presence of uninsulated dangerous voltage within the product's enclosure that may present a risk of electric shock.

Caution

Read Instructions • Read and understand all safety and operating instructions before using the equipment.

Retain Instructions • The safety instructions should be kept for future reference.

Follow Warnings • Follow all warnings and instructions marked on the equipment or in the user information.

Avoid Attachments • Do not use tools or attachments that are not recommended by the equipment manufacturer because they may be hazardous.

Consignes de Sécurité • Français



Ce symbole sert à avertir l'utilisateur que la documentation fournie avec le matériel contient des instructions importantes concernant l'exploitation et la maintenance (réparation).



Ce symbole sert à avertir l'utilisateur de la présence dans le boîtier de l'appareil de tensions dangereuses non isolées posant des risques d'électrocution.

Attention

Lire les instructions • Prendre connaissance de toutes les consignes de sécurité et d'exploitation avant d'utiliser le matériel.

Conservier les instructions • Ranger les consignes de sécurité afin de pouvoir les consulter à l'avenir.

Respecter les avertissements • Observer tous les avertissements et consignes marqués sur le matériel ou présentés dans la documentation utilisateur.

Éviter les pièces de fixation • Ne pas utiliser de pièces de fixation ni d'outils non recommandés par le fabricant du matériel car cela risquerait de poser certains dangers.

Sicherheitsanleitungen • Deutsch



Dieses Symbol soll dem Benutzer in der im Lieferumfang enthaltenen Dokumentation besonders wichtige Hinweise zur Bedienung und Wartung (Instandhaltung) geben.



Dieses Symbol soll den Benutzer darauf aufmerksam machen, daß im Inneren des Gehäuses dieses Produktes gefährliche Spannungen, die nicht isoliert sind und die einen elektrischen Schock verursachen können, herrschen.

Achtung

Lesen der Anleitungen • Bevor Sie das Gerät zum ersten Mal verwenden, sollten Sie alle Sicherheits- und Bedienungsanleitungen genau durchlesen und verstehen.

Aufbewahren der Anleitungen • Die Hinweise zur elektrischen Sicherheit des Produktes sollten Sie aufbewahren, damit Sie im Bedarfsfall darauf zurückgreifen können.

Befolgen der Warnhinweise • Befolgen Sie alle Warnhinweise und Anleitungen auf dem Gerät oder in der Benutzerdokumentation.

Keine Zusatzgeräte • Verwenden Sie keine Werkzeuge oder Zusatzgeräte, die nicht ausdrücklich vom Hersteller empfohlen wurden, da diese eine Gefahrenquelle darstellen können.

Instrucciones de seguridad • Español



Este símbolo se utiliza para advertir al usuario sobre instrucciones importantes de operación y mantenimiento (o cambio de partes) que se desean destacar en el contenido de la documentación suministrada con los equipos.



Este símbolo se utiliza para advertir al usuario sobre la presencia de elementos con voltaje peligroso sin protección aislante, que puedan encontrarse dentro de la caja o alojamiento del producto, y que puedan representar riesgo de electrocución.

Precaucion

Leer las instrucciones • Leer y analizar todas las instrucciones de operación y seguridad, antes de usar el equipo.

Conservar las instrucciones • Conservar las instrucciones de seguridad para futura consulta.

Obedecer las advertencias • Todas las advertencias e instrucciones marcadas en el equipo o en la documentación del usuario, deben ser obedecidas.

Evitar el uso de accesorios • No usar herramientas o accesorios que no sean específicamente recomendados por el fabricante, ya que podrían implicar riesgos.

Warning

Power sources • This equipment should be operated only from the power source indicated on the product. This equipment is intended to be used with a main power system with a grounded (neutral) conductor. The third (grounding) pin is a safety feature, do not attempt to bypass or disable it.

Power disconnection • To remove power from the equipment safely, remove all power cords from the rear of the equipment, or the desktop power module (if detachable), or from the power source receptacle (wall plug).

Power cord protection • Power cords should be routed so that they are not likely to be stepped on or pinched by items placed upon or against them.

Servicing • Refer all servicing to qualified service personnel. There are no user-serviceable parts inside. To prevent the risk of shock, do not attempt to service this equipment yourself because opening or removing covers may expose you to dangerous voltage or other hazards.

Slots and openings • If the equipment has slots or holes in the enclosure, these are provided to prevent overheating of sensitive components inside. These openings must never be blocked by other objects.

Lithium battery • There is a danger of explosion if battery is incorrectly replaced. Replace it only with the same or equivalent type recommended by the manufacturer. Dispose of used batteries according to the manufacturer's instructions.

Avertissement

Alimentations • Ne faire fonctionner ce matériel qu'avec la source d'alimentation indiquée sur l'appareil. Ce matériel doit être utilisé avec une alimentation principale comportant un fil de terre (neutre). Le troisième contact (de mise à la terre) constitue un dispositif de sécurité : n'essayez pas de le contourner ni de le désactiver.

Déconnexion de l'alimentation • Pour mettre le matériel hors tension sans danger, déconnectez tous les cordons d'alimentation de l'arrière de l'appareil ou du module d'alimentation de bureau (s'il est amovible) ou encore de la prise secteur.

Protection du cordon d'alimentation • Acheminer les cordons d'alimentation de manière à ce que personne ne risque de marcher dessus et à ce qu'ils ne soient pas écrasés ou pincés par des objets.

Réparation-maintenance • Faire exécuter toutes les interventions de réparation-maintenance par un technicien qualifié. Aucun des éléments internes ne peut être réparé par l'utilisateur. Afin d'éviter tout danger d'électrocution, l'utilisateur ne doit pas essayer de procéder lui-même à ces opérations car l'ouverture ou le retrait des couvercles risquent de l'exposer à de hautes tensions et autres dangers.

Fentes et orifices • Si le boîtier de l'appareil comporte des fentes ou des orifices, ceux-ci servent à empêcher les composants internes sensibles de surchauffer. Ces ouvertures ne doivent jamais être bloquées par des objets.

Lithium Batterie • Il a danger d'explosion s'il y a un remplacement incorrect de la batterie. Remplacer uniquement avec une batterie du même type ou d'un type équivalent recommandée par le constructeur. Mettre au rebut les batteries usagées conformément aux instructions du fabricant.

Vorsicht

Stromquellen • Dieses Gerät sollte nur über die auf dem Produkt angegebene Stromquelle betrieben werden. Dieses Gerät wurde für eine Verwendung mit einer Hauptstromleitung mit einem geerdeten (neutralen) Leiter konzipiert. Der dritte Kontakt ist für einen Erdschluss, und stellt eine Sicherheitsfunktion dar. Diese sollte nicht umgangen oder außer Betrieb gesetzt werden.

Stromunterbrechung • Um das Gerät auf sichere Weise vom Netz zu trennen, sollten Sie alle Netzkabel aus der Rückseite des Gerätes, aus der externen Stromversorgung (falls dies möglich ist) oder aus der Wandsteckdose ziehen.

Schutz des Netzkabels • Netzkabel sollten stets so verlegt werden, daß sie nicht im Weg liegen und niemand darauf treten kann oder Objekte darauf- oder unmittelbar dagegengestellt werden können.

Wartung • Alle Wartungsmaßnahmen sollten nur von qualifiziertem Servicepersonal durchgeführt werden. Die internen Komponenten des Gerätes sind wartungsfrei. Zur Vermeidung eines elektrischen Schocks versuchen Sie in keinem Fall, dieses Gerät selbst öffnen, da beim Entfernen der Abdeckungen die Gefahr eines elektrischen Schlags und/oder andere Gefahren bestehen.

Schlitze und Öffnungen • Wenn das Gerät Schlitze oder Löcher im Gehäuse aufweist, dienen diese zur Vermeidung einer Überhitzung der empfindlichen Teile im Inneren. Diese Öffnungen dürfen niemals von anderen Objekten blockiert werden.

Lithium-Batterie • Explosionsgefahr, falls die Batterie nicht richtig ersetzt wird. Ersetzen Sie verbrauchte Batterien nur durch den gleichen oder einen vergleichbaren Batterietyp, der auch vom Hersteller empfohlen wird. Entsorgen Sie verbrauchte Batterien bitte gemäß den Herstelleranweisungen.

Advertencia

Alimentación eléctrica • Este equipo debe conectarse únicamente a la fuente/tipo de alimentación eléctrica indicada en el mismo. La alimentación eléctrica de este equipo debe provenir de un sistema de distribución general con conductor neutro a tierra. La tercera pata (puesta a tierra) es una medida de seguridad, no puentearla ni eliminarla.

Desconexión de alimentación eléctrica • Para desconectar con seguridad la acometida de alimentación eléctrica al equipo, desenchufar todos los cables de alimentación en el panel trasero del equipo, o desenchufar el módulo de alimentación (si fuera independiente), o desenchufar el cable del receptáculo de la pared.

Protección del cables de alimentación • Los cables de alimentación eléctrica se deben instalar en lugares donde no sean pisados ni apretados por objetos que se puedan apoyar sobre ellos.

Reparaciones/mantenimiento • Solicitar siempre los servicios técnicos de personal calificado. En el interior no hay partes a las que el usuario deba acceder. Para evitar riesgo de electrocución, no intentar personalmente la reparación/mantenimiento de este equipo, ya que al abrir o extraer las tapas puede quedar expuesto a voltajes peligrosos u otros riesgos.

Ranuras y aberturas • Si el equipo posee ranuras o orificios en su caja/alojamiento, es para evitar el sobrecalentamiento de componentes internos sensibles. Estas aberturas nunca se deben obstruir con otros objetos.

Batería de litio • Existe riesgo de explosión si esta batería se coloca en la posición incorrecta. Cambiar esta batería únicamente con el mismo tipo (o su equivalente) recomendado por el fabricante. Desachar las baterías usadas siguiendo las instrucciones del fabricante.

Quick Start — DVS 204

Installation

Step 1

Refer to the application examples at the end of this page. Turn off power to the scaler and input and output devices, and remove power cords from them.

Step 2

Install the four rubber feet on the bottom of the DVS 204 scaler, or mount the scaler in a rack.

Step 3

Attach input devices to the scaler.

Rear panel video inputs

Input 1: Composite video



Input 2: Composite/S-video/Component

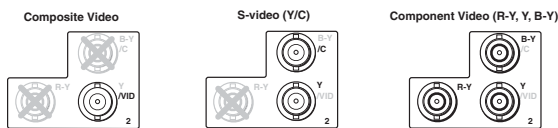

Input 3: S-video



Input 4: RGB pass-through/RGBS/RGBcS



SDI input

Attach an SDI source to this BNC (204 D model only).



Step 4

Attach output devices to the scaler.

Rear panel video outputs

Output BNC connectors

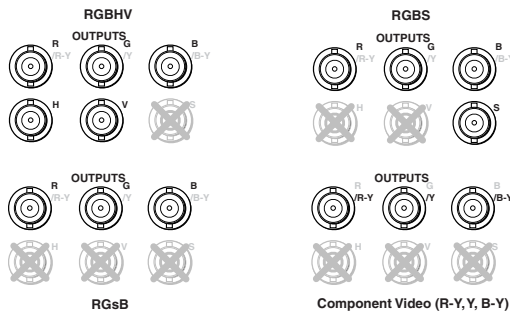

Output 15-pin HD connector



NOTE You can connect both outputs simultaneously to two different displays. The sync format is the same for both outputs.

Step 5

Plug the DVS 204, and input and output devices into a grounded AC source, and turn on the input and output devices.

Step 6

Use the LCD menu screens or RS-232 programming to configure the scaler. See chapter two for installation and operation procedures, and see chapter three for programming information.

Application examples

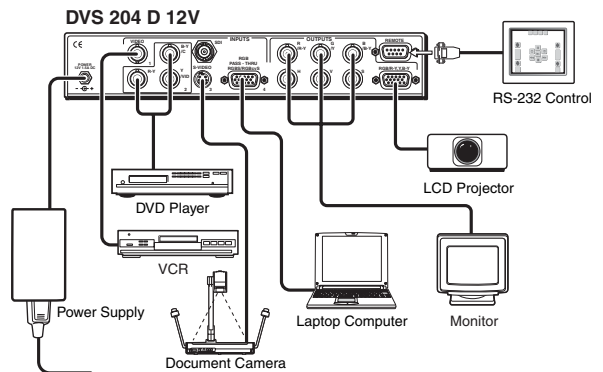
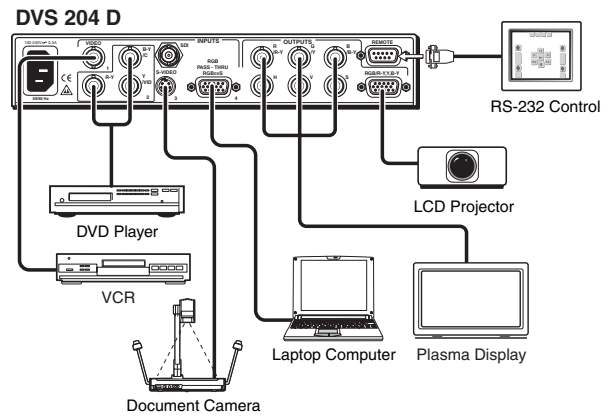

Quick Start — DVS 204, cont'd

Table of Contents

Chapter 1 • Introduction	1-1
About this Manual	1-2
About the DVS 204	1-2
What is the DVS 204?	1-2
Controlling the DVS 204 digital video scaler	1-2
Features and Options	1-2
Features	1-2
Options and accessories	1-3
Chapter 2 • Installation and Operation	2-1
Mounting the Scaler	2-2
Tabletop/desktop placement	2-2
Rack mounting	2-2
Application diagram	2-3
Rear Panel Features	2-4
Front Panel Features	2-7
Input selection buttons	2-7
Picture adjustment buttons	2-7
Menu button	2-8
Next button	2-8
LCD menu display and controls	2-8
Optimizing the System for a DVD	2-8
Setting up a DVD source	2-8
Menus, Configuration, and Adjustments	2-9
Moving through menus by using front panel controls	2-9
Menu overview	2-9
Input Configuration	2-10
Input 2 Video Type	2-11
Input 4 Video Type	2-11
SDI Input (SDI IN)	2-11
Output Configuration	2-11
Resolution and refresh rates	2-12
Output Signal	2-12
Sync Polarity	2-12
H Format	2-13
Blanking Configuration	2-13
Top and bottom blanking	2-13
Memory Preset	2-13
Save (SAVE) memory preset	2-14
Clear (CLR) memory preset	2-14
Recalling a preset	2-15
Advanced Configuration	2-15
Detail control	2-15
Filter mode	2-15
Blue mode	2-16

Table of Contents, cont'd

Autoswitch (Autosw) mode	2-16
Enhanced (Enh) mode	2-16
2:2 Pulldown detection (PAL Film mode detect) submenu	2-16
RGB delay (Triple Action Switching)	2-16
Exit Menu	2-17
Image Adjustments	2-17
Color, tint, brightness, contrast, centering, sizing	2-17
Input Reset	2-18
System Reset	2-18
Front Panel Security Lockout (Executive Mode)	2-19
IR 901 Infrared Remote Control	2-20
Aspect ratio presets	2-20
Freezing an input	2-20
Selecting an input	2-20
Size and center	2-20
Image adjustments	2-20
Troubleshooting	2-21
Operating problems	2-21
Chapter 3 • Serial Communication	3-1
RS-232 Programmer's Guide	3-2
Host-to-scaler communications	3-2
Scaler-initiated messages	3-2
Error responses	3-2
Using the command/response tables	3-3
Command/response table for SIS commands	3-4
Command/response table for special function SIS commands	3-7
Control Software for Windows	3-8
Installing the software	3-8
Using the control program	3-8
Using the help program	3-9
Appendix A • Appendix	A-1
Specifications	A-2
Part Numbers and Accessories	A-4
Included parts	A-4
Accessories	A-4
Firmware Upgrade Installation	A-5
Serial Digital Interface (SDI) Card Installation	A-7

All trademarks mentioned in this manual are the properties of their respective owners.



DVS 204

Chapter One

Introduction

About this Manual

About the DVS 204

Features and Options

Introduction

About this Manual

This manual discusses how to install, configure, and operate the Extron DVS 204 digital video scaler and how to operate the optional IR 901 infrared remote control (part #70-152-01).

Throughout this manual the terms “DVS”, “digital video scaler”, and “scaler” are used interchangeably to refer to the same product.

About the DVS 204

What is the DVS 204?

The DVS is a series of high performance digital video scalers that offers 56 output rates, including HDTV, and provides scaling solutions for boardrooms, conference rooms, and home theaters, as well as rental and staging applications.

The scalers come in four models, two of which offer a serial digital interface (SDI) input connector: DVS 204 (no SDI), DVS 204 D (SDI), DVS 204 12V (12 volt external power supply, no SDI), and DVS 204 D 12V (12 volt external power supply, SDI).

To enable superior scaling performance, the DVS 204 features several of Extron’s patented and patent-pending technologies, including Dynamic Motion Interpolation (DMI™) technology, and 3:2 and 2:2 pulldown detection. DMI is an advanced motion detection and compensation method that enables image enhancement with no loss of image fidelity.

The DVS 204 scales composite video, S-video, and component video up to computer-video (RGBHV/RGBS/RGsB) or HD component, which can be output to two display devices via individually buffered BNC and 15-pin HD connectors.

Controlling the DVS 204 digital video scaler

The DVS 204 can be controlled using one or more of the following methods:

- The front panel controls.
- A computer, a touch screen panel, or any other device that can send and receive the serial communications through the RS-232 port. Extron’s Simple Instruction Set (SIS™) is a set of simple keystroke commands that can be used with any such devices, and Extron’s control software for Windows provides a graphical interface for controlling the scaler from a computer.
- The optional IR 901 remote control, which has most of the front panel controls.

Features and Options

Features

Four video inputs

- **Input 1** — One BNC connector on the rear panel accepts composite video.
- **Input 2** — Three BNC connectors on the rear panel accept composite, component, or S-video.
- **Inputs 3** — One 4-pin DIN connector accepts an S-video signal.
- **Input 4** — One 15-pin HD connector accepts an RGB pass-through (RGBHV, RGBS, RGSB), RGBS, or RGBcvS video signal.

SDI video input (optional) — One BNC connector on the rear panel accepts SDI video.

Buffered video outputs — Six rear-panel BNC connectors and one VGA-type 15-pin HD connector provide connections for RGB output. Both outputs (the BNCs or the 15-pin HD connector) are active at all times for simultaneous output.

Three ways to control the scaler — The scaler's front panel, a computer or other RS-232 control device, or the optional IR 901 remote control can all be used to control the scaler.

Scaled outputs — The DVS 204 offers 59 different output rates.

RS-232 configuration — The DVS 204 can be configured by using the Extron control software for Windows, or by using a third party control system.

Accu-RATE Frame Lock™ — The Extron Accu-RATE Frame Lock™ eliminates artifacts from scaled motion video by eliminating frame rate conversion. It locks the output frame rate to the input frame rate of the active input. The result is a switching system that eliminates image tears and other artifacts from motion video.

Dynamic Motion Interpolation™ (DMI™) — This video processing technique is an advanced motion prediction and compensation method that treats motion content and still content with different algorithms to yield high fidelity images.

3:2 pulldown detection for NTSC and 2:2 film detection for PAL video sources — These advanced film mode processing features help maximize image detail and sharpness for video sources that originated from film. When film is converted to NTSC video, the film frame rate has to be matched to the video frame rate in a process called 3:2 pulldown. Jaggies and other image artifacts can result if conventional deinterlacing techniques are used on film-source video. The DVS 204's advanced film mode processing recognizes signals that originated from film. The DVS 204 then applies video processing algorithms that optimize the conversion of video that was made with the 3:2 pulldown process. This results in richly detailed images with sharply defined lines. A similar process is used for PAL film-source video.

Versatile mounting options — The DVS 204 is 1U high, and a half rack wide. It is rack mountable, or it can be placed on a table or other furniture. Rubber feet are included.

Options and accessories

The DVS 204's optional equipment includes:

- **IR 901 remote control** — Extron's IR 901 (part #70-152-01) is an infrared remote control which replicates all of the front panel controls of the DVS 204 except the Menu and Next buttons.
- **SDI input card** — Serial digital interface (SDI) input can be added to the DVS 204 model by the installation of an SDI input card (part #70-168-01).
- **Rack shelf mounting kit** — The 1U high, half rack width DVS 204 can be rack mounted using the rack shelf mounting kit (part #60-190-01).

Introduction, cont'd



DVS 204

Chapter Two

Installation and Operation

Mounting the Scaler

Rear Panel Features

Front Panel Features

Optimizing the System for a DVD

Menus, Configuration, and Adjustments

Image Adjustments

Input Reset

System Reset

Front Panel Security Lockout (Executive Mode)

IR 901 Infrared Remote Control

Troubleshooting

Installation and Operation

Mounting the Scaler

Tabletop/desktop placement

For tabletop or desktop placement only, install the self-adhesive rubber feet/pads (provided) onto the four corners of the bottom of the enclosure.

Rack mounting

1. If feet were installed on the bottom of the DVS 204, remove them.
2. Place the DVS 204 on one half of the 1U (one unit high, one unit wide) rack shelf (part #60-190-01). Align the front of the DVS 204 with the front of the shelf, and align the threaded holes on the bottom of the DVS 204 with the holes in the rack shelf.
3. Attach the DVS to the rack shelf with the two provided 4-40 x 3/16" machine screws. Insert the screws from the underside of the shelf, and securely fasten them into diagonally-opposite corners.

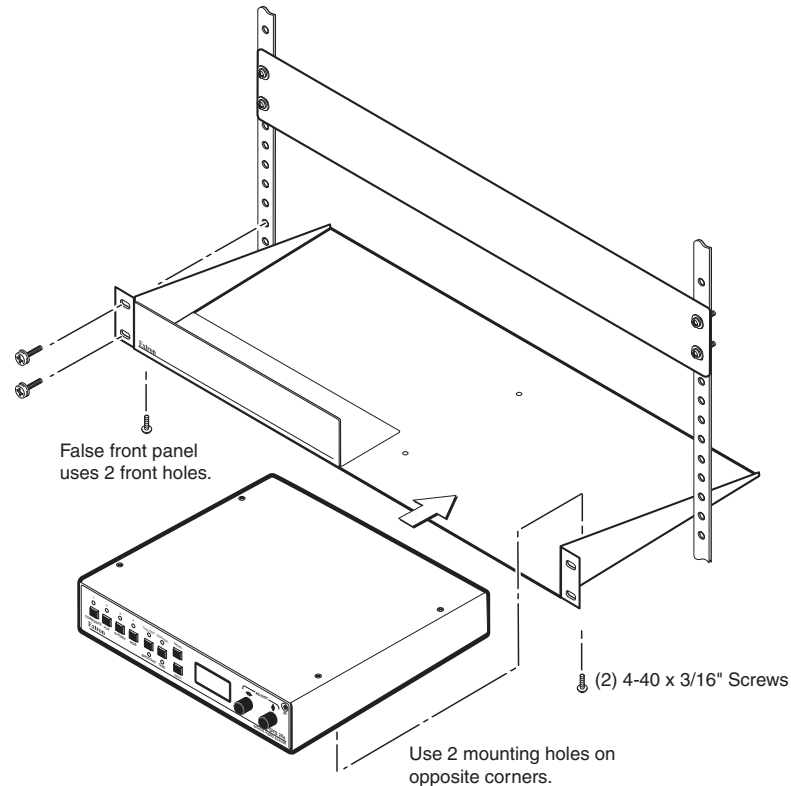

Rack mounting the DVS 204

4. Attach the false front panel (provided with the rack shelf) to the unoccupied side of the rack (as shown above), or install a second half-rack-width device in that side by repeating steps 1-3.
5. Attach the rack shelf to the rack using four 10-32 x 3/4" bolts (provided). Insert the bolts through #10 beveled washers, then through the holes in the rack ears and rack, as shown above.

Application diagram

The diagram shown below is an example of a typical DVS 204 application with cable connections.

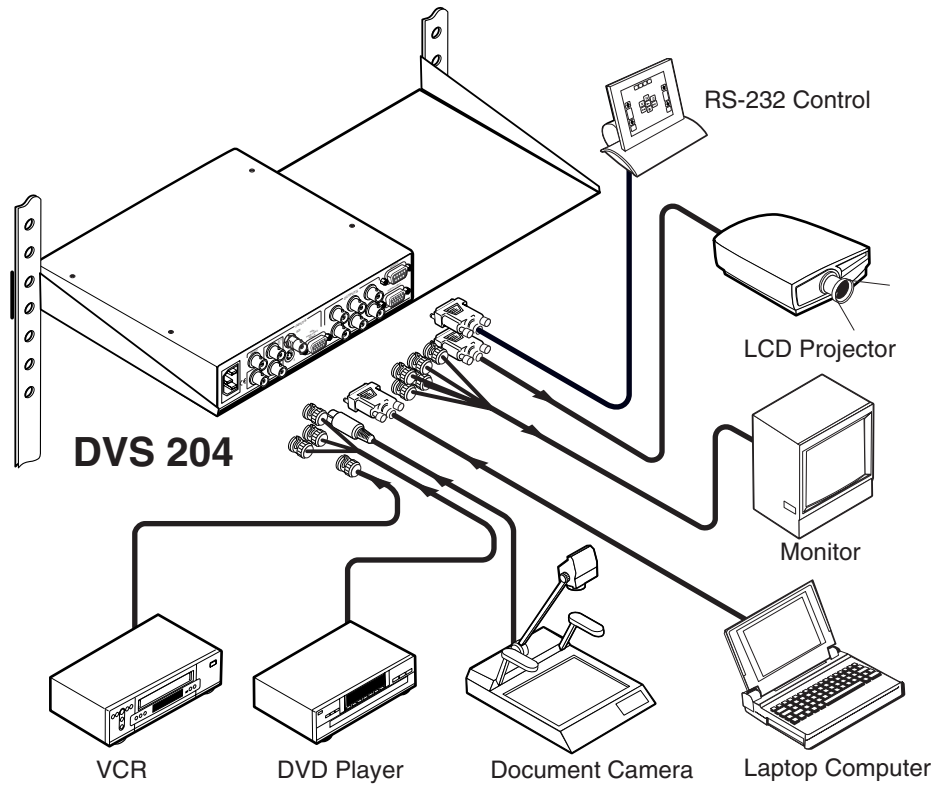

Application diagram example of the DVS 204

Installation and Operation

Rear Panel Features

The rear panels of the DVS 204 D and DVS 204 D 12V models, as shown below, contain all of the possible connectors available on the DVS 204 series of scalers (the DVS 204 and DVS 12V models do not come with an SDI input connector).

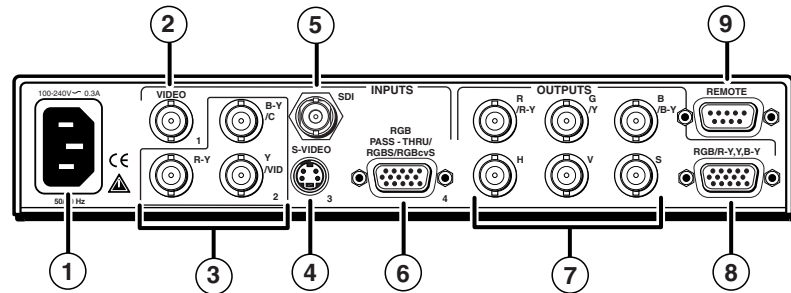

DVS 204 D rear panel connectors

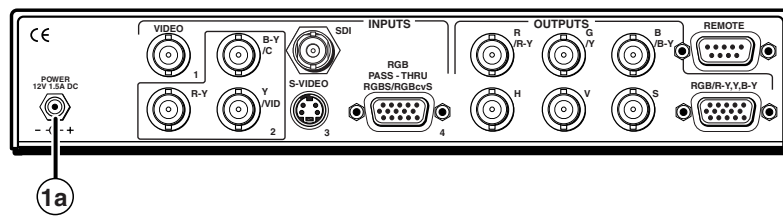

DVS 204 D 12V rear panel power connector

NOTE The rear panel connectors of the 12V DC models are identical to those of the AC models, except for the 12 volt power input connector.

- ① **AC power connector** — Plug a standard IEC power cord into this connector to connect the scaler to a 100 to 240 VAC, 50 Hz or 60 Hz power source. The front panel control and input selection LEDs will light during power-up.
- ①a **12V DC power connector** — Plug the included 12 V power supply into this input jack (DVS 204 12V and DVS 204 D 12V models only). The front panel control and input selection LEDs will light during power-up.
- ② **Video input 1: Composite video** — A composite video signal is input through the female BNC connector. 
- ③ **Video input 2: Composite/S-video/Component** — This input, consisting of 3 female BNC connectors, accepts composite video, S-video, and component video signals. Connect cables for the appropriate signal type, as shown here.

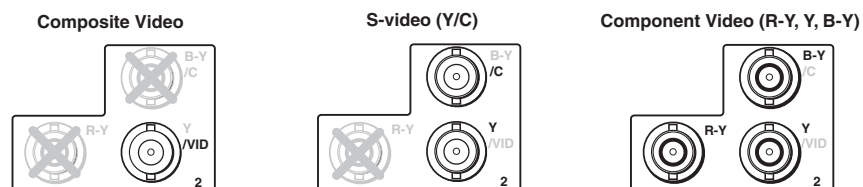

- ④ **Video input 3: S-video** — Connect an S-video signal to this 4-pin mini-DIN female connector.



- ⑤ **SDI (serial digital interface) input connector** — Connect an SDI signal to this female BNC connector.



NOTE Only the DVS 204 D and DVS 204 D 12V models have an SDI connector.

- ⑥ **Video input 4: RGB pass-through, RGBS, or RGBcvs** — Connect an RGB pass-through (RGBHV, RGBS, RGsB), RGBS, or RGBcvs video signal to this 15-pin HD connector. The pass-through signals are not scalable.



NOTE Equipment following the SCART interconnection standard may be connected to the RGBcvs input cabling configuration.

- ⑦ **RGB (RGBHV, RGBS, RGsB) or HD component (R-Y, Y, B-Y) video BNC output** — Connect coaxial cables from a display device to these BNCs for a scaled or pass-through RGB or a scaled component video output. The output can be scaled to 56 different output rates. The scaled inputs (1-3) are output, as shown below.

NOTE The default for the “H” BNC connector is always horizontal sync. See the following section “RGB pass-through”, for the only exception to this rule.

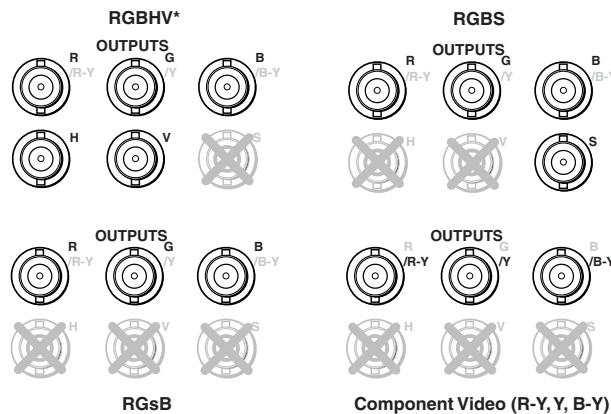

NOTE Outputs ⑦ and ⑧ are both buffered and can be connected simultaneously to two different displays. For RGB inputs, the output signal’s sync format is based on the format of the incoming RGB signal. For all other types of inputs, the user selects the output sync format. The sync format will be the same for both outputs.

RGB pass-through — An RGB pass-through signal with composite sync (“RGB” is selected for input 4; see the *Input Configuration* section in this chapter) will always output composite sync through the “H” BNC output connector, as shown in the following illustration.

NOTE If both an RGB pass-through signal with composite sync **and** a scaled video input (1-3) are output as RGBS, the H Format must be set to “HV” (composite sync). This will cause the scaled video input to output composite sync on the same connector (the “H” BNC) as the pass-through signal instead of the “S” BNC. See the H Format section in this chapter.

NOTE For scaled inputs on input 4 (RGBS or RGBcvs), the H Format **will not** have to be set to “HV” since those inputs will be output like inputs 1-3, as shown in the previous connection diagram.

Installation and Operation, cont'd

RGBS from RGBS pass-through input

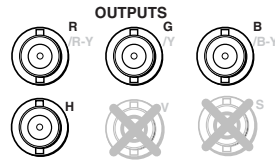

- ⑧ **RGB or HD component (R-Y, Y, B-Y) 15-pin HD video output** — Connect an RGB video display or HD component video display to this connector.
- ⑨ **Remote (RS-232/contact closure) 9-pin port** — This connector provides for two-way RS-232 communication and contact closure control. See chapter three, “Serial Communication”, for information on how to install and use the control software and SIS commands.

The default protocol is 9600 baud, 1 stop bit, no parity, and no flow control.

The rear panel RS-232 9-pin D female connector has the following pin assignments:

Pin	RS-232 function	Description
1	Input #1	Contact closure
2	Tx	Transmit data
3	Rx	Receive data
4	Input #2	Contact closure
5	Gnd	Signal ground
6	Input #3	Contact closure
7	Input #4	Contact closure
8	–	No connection
9	Hardwired IR	IR input

The Remote connector also provides a way to select an input using a remote contact closure device. Contact closure control uses pins on the Remote connector that are not used by the RS-232 interface (see preceding table).

To select a different input number using a contact closure device, momentarily short the pin for the desired input number to logic ground (pin 5). To force one of the inputs to be always selected, leave the short to logic ground in place. The short overrides front panel input selections.

Front Panel Features

The front panel buttons, controls, LCD, and infrared sensor of the DVS 204, as shown below, are found on all models of the DVS 204 scaler series. The LEDs above each input button will light green and the LEDs above/below each picture control button will light amber when the button is pressed.

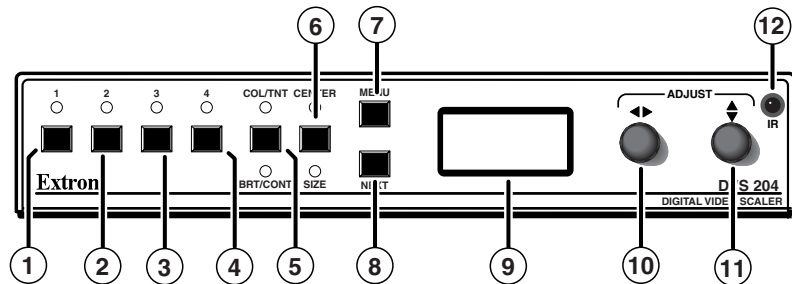

DVS 204 front panel

Input selection buttons

- ① **Composite input button** — This button selects composite video input (Input 1).
- ② **Composite/YC/component input button** — This button selects composite video, YC, or component video input (Input 2).
- ③ **S-video input button** — This button selects the S-video input (Input 3).
- ④ **RGB pass-through/RGBS/RGBcvS input button** — This button selects the RGB pass-through (RGBHV, RGBS, RGsB), RGBS (15 kHz), or RGBcvS input (Input 4).

NOTE An SDI input signal can be assigned to any of the inputs (Inputs 1 through 4).

Picture adjustment buttons

Pressing these buttons successively will toggle between the different picture adjustment functions and light the LEDs above and below each button.

NOTE These buttons have no effect on the RGB pass-through inputs (Input 4).

- ⑤ **Color/Tint control button (Col/Tnt)** — This button controls the color and tint adjustment on the display by using the Adjust horizontal and Adjust vertical adjustment knobs. The adjustment range of both color and tint is 0 to 255. See the “Image Adjustments” section in this chapter.

NOTE The tint control is not available if the input is component video.

Brightness/Contrast control button (Brt/Cont) — This button controls the brightness and contrast adjustment on the display by using the Adjust horizontal and Adjust vertical adjustment knobs. The adjustment range of both brightness and tint is 0 to 255. See the “Image Adjustments” section in this chapter.

- ⑥ **Center control button** — This button controls the centering adjustment on the output display by using the Adjust horizontal and Adjust vertical adjustment knobs. The adjustment range of both horizontal and vertical centering is 0 to +255. See the “Image Adjustments” section in this chapter.

Installation and Operation, cont'd

Size control button — This button controls the size adjustment on the display by using the Adjust horizontal and Adjust vertical adjustment knobs. See the “Image adjustments” section in this chapter.

Menu button

- ⑦ **Menu button** — Use this button to enter and move through the main menu system in the DVS 204. See the “Menus, Configuration, and Adjustments” section in this chapter for details.

Next button

- ⑧ **Next button** — Use this button to step through the submenus in the DVS 204 menu system. See the “Menus, Configuration, and Adjustments” section in this chapter for details.

LCD menu display and controls

- ⑨ **LCD** — Displays configuration menus and status information. See the “Menus, Configuration, and Adjustments” section in this chapter for details.
- ⑩ **Adjust horizontal (◀▶) knob** — In the menu system, rotate this knob to scroll through menu options and make adjustments.
- ⑪ **Adjust vertical (⬆⬇) knob** — In the menu system, rotate this knob to scroll through menu options and make adjustments.
- ⑫ **Infrared sensor** — This sensor is used to receive infrared (IR) signals from the IR-901 remote control. See the “IR 901 Infrared Remote Control” section in this chapter.

Optimizing the System for a DVD

For optimal performance, follow the steps in this section in order when setting up the DVS 204 for a DVD.

Setting up a DVD source

To get the best results when using a DVD as a video source, Extron recommends that the DVD player itself be setup to output an aspect ratio of 16:9 and not 4:3. Because all DVDs are mastered as 16:9, having them set up for anything else will cause the player to internally scale and compress the signal. This scaling/compression by the DVD player will defeat the advantage of having 3:2 pulldown detection in the DVS 204.

All sizing adjustments to correct aspect ratio should be done using the DVS 204.

To change the output aspect ratio of most DVD players,

1. Enter the DVD player’s Setup or Action menu while the disc is stopped.
2. Select a 16:9 aspect ratio.

Menus, Configuration, and Adjustments

Scaler configuration and adjustments can be performed by using the Windows-based control program (see chapter three for details) or by using the front panel controls and the menus that are displayed on the DVS 204's LCD screen. These menus are used primarily when the scaler is first set up.

Moving through menus by using front panel controls

Menu button — Press the Menu button to activate menus and to scroll to the six main menus.

Next button — Press the Next button to move between the submenus of a selected main menu. Pressing the Next button during input configuration causes the current input's number and format type to be displayed on the LCD.

Adjust (◀▶, ⬆) knobs — In configuration mode, rotate the Adjust horizontal (◀▶) knob and Adjust vertical (⬆) knob to scroll through submenu options and to make adjustment selections. Refer to the flowcharts in this chapter and to specific sections for explanations on knob adjustments.

Image adjustment buttons: Col/Tnt, (color/tint) Brt/Cont (brightness/contrast), Size, and Center — When one of these buttons is pressed successively, the corresponding image adjustment menu appears on the LCD screen. Adjustments can then be made by rotating the Adjust horizontal (◀▶) knob or the Adjust vertical (⬆) knob. Settings and adjustments are stored in nonvolatile memory.

Menu overview

The default menus appear on the LCD when no adjustments are actively being made. They cycle between the screen showing the model of the scaler (DVS 204 or DVS 204 D) and the screen that shows the active input's number and video format, as shown below.

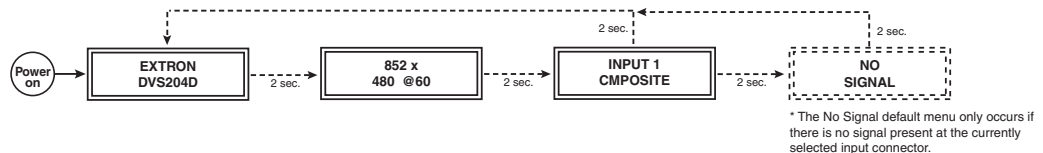

Default menus

NOTE From any menu or submenu, after ten seconds of inactivity the DVS 204 will save all adjustment settings and time-out to the default menu.

The main menus are as shown in the following flowchart. Use the Menu key to scroll between them.

NOTE The No Signal default menu only occurs if there is no signal present at the currently selected input connector.

Installation and Operation, cont'd

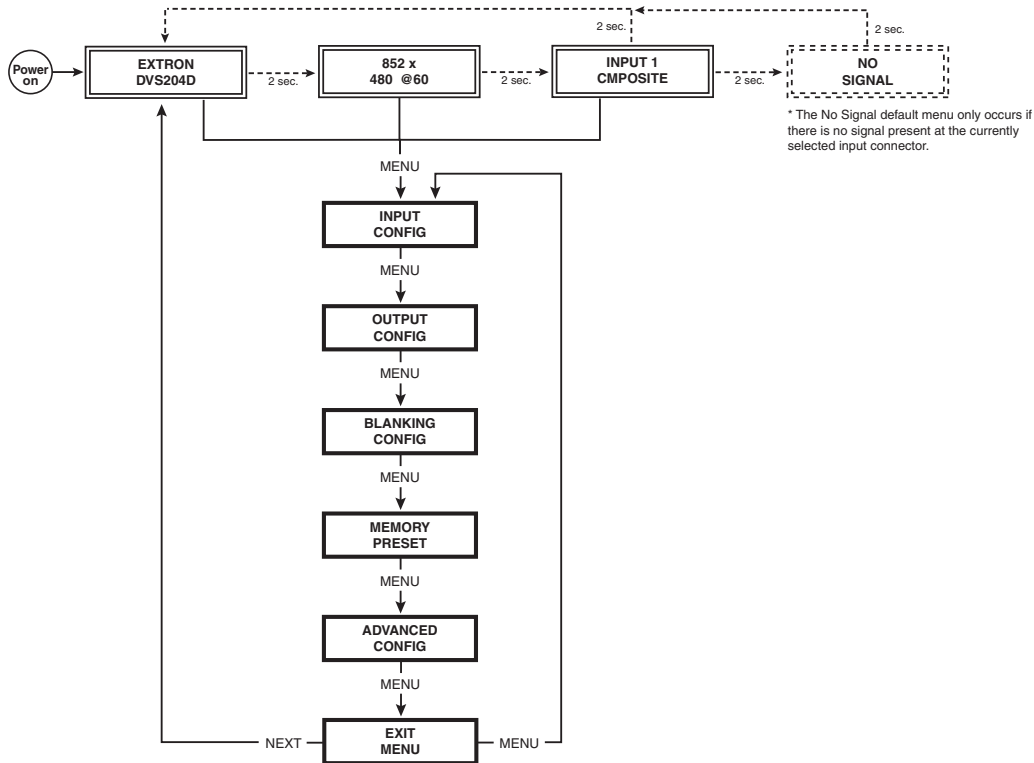

Main menus

NOTE To return to the default screens, let the DVS 204 time-out for 10 seconds, or press the Menu button until the Exit Menu menu appears, then press the Next button.

NOTE Submenus are accessed from a main menu by pressing the Next button. If you press the Menu button while a submenu is active, the next main menu will become active. For example, the menu will change from the Input Configuration menu or its submenus to the Output Configuration main menu.

Input Configuration

The following flowchart provides an overview of the Input Configuration submenus and the options for each setting.

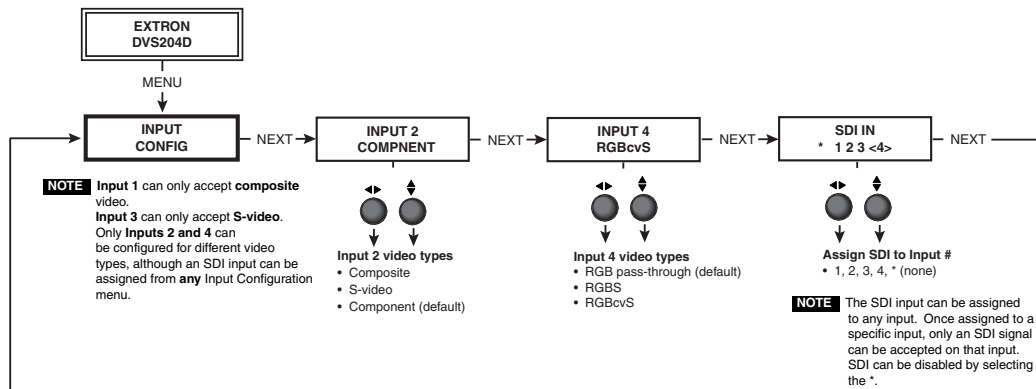

NOTE Input 1 can only input composite video, and Input 3 can only input S-video, no other video types are selectable for these inputs. Only Inputs 2 and 4 offer selectable video types. From the Input Configuration menu, pressing the Next key successively will display submenus with the input video types for Inputs 2 and 4. The SDI input (if any) can be assigned to any input from the Input Configuration submenus.

Input 2 Video Type

Rotate either the Adjust horizontal (◀▶) knob or Adjust vertical (⬆️) knob while in the Input 2 submenu to select the appropriate video format (composite, S-video, component) for Input 2. The default is component video.

Input 4 Video Type

Rotate the Adjust horizontal (◀▶) knob while in the Input 4 submenu to select the appropriate video format (RGB pass-through, RGBS, RGBcvS) for Input 4. The default is RGB pass-through.

SDI input (SDI IN)

Rotate either the Adjust horizontal (◀▶) knob or Adjust vertical (⬆️) knob while in the SDI Input submenu to select the input # for the SDI input. The SDI input can be assigned to Inputs 1, 2, 3, 4, or none (*). The default is none.

NOTE After the SDI input is no longer assigned to an input, either because it has been assigned to a new input or is set to none, the input reverts back to the last video type that was assigned to it.

Output Configuration

The following flowchart provides an overview of the Output Configuration submenus and the options for each setting.

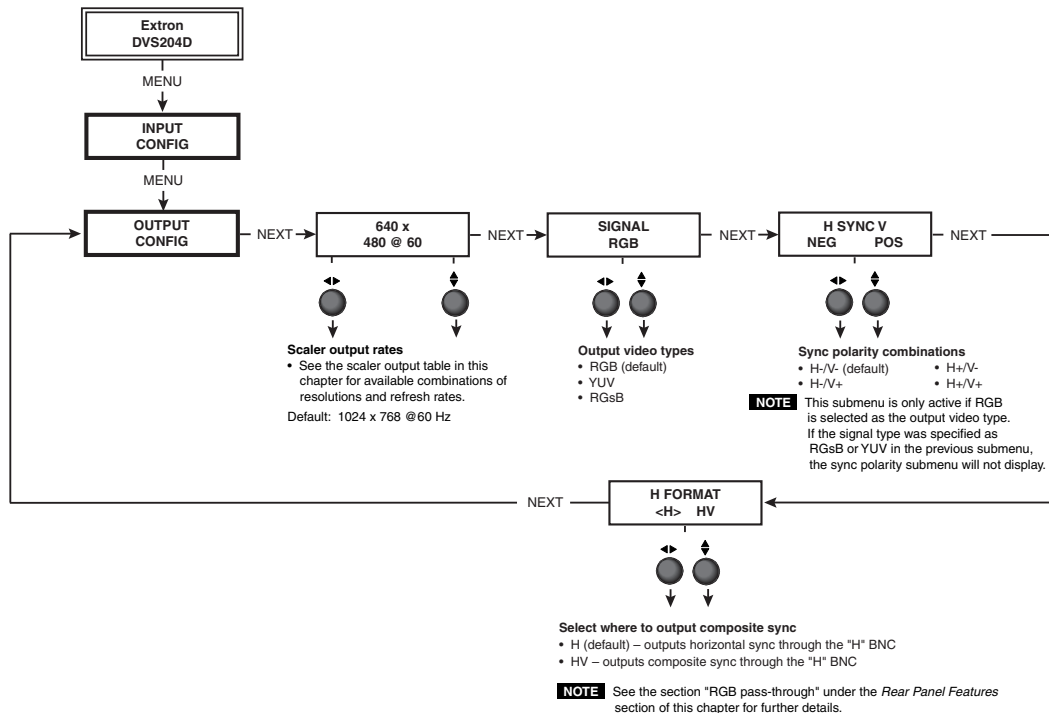

Installation and Operation, cont'd

Resolution and refresh rates

Rotate the Adjust horizontal (◀▶) knob while in this submenu to select one of the available combinations of output resolutions and refresh (vertical scanning) rates.

Rotate the Adjust vertical (⬆️) knob while in this submenu to select one of the available refresh rates. Selecting @60L (Lock) refresh rate enables the Extron Accu-RATE Frame Lock™ (AFL™) (patent pending) feature. Accu-RATE Frame Lock eliminates image tearing and other artifacts of scaling motion video by eliminating frame rate conversion. It exactly matches the output rate of the DVS 204's scaler to the frame rate of the active input. Select this feature if you will be using motion video sources with a display that is capable of a variety of refresh rates.

Available Scaler Output Resolutions and Rates						
Resolution	50 Hz	56 Hz	60 Hz	75 Hz	Lock @ 50/60*	True 72/100*
640 x 480	X		X	X	X	X
800 x 600	X		X	X	X	X
848 x 480	X		X	X	X	X
852 x 480	X		X	X	X	X
1024 x 768	X		X	X	X	X
1280 x 768		X			X	X
1280 x 1024	X		X	X	X	**
1360 x 765	X		X	X	X	X
1365 x 1024	X		X	X	X	**
1400 x 1050	X		X	X	X	X
HDTV 480p			X		X	
HDTV 576p	X				X	
HDTV 720p			X		X	
HDTV 1080p			X		X	
HDTV 1080i	X		X		X	

*Rate is autoselected based on input

** NTSC only; no 100 Hz rate

The default resolution and rate is 1024 x 768 @ 60Hz.

Output Signal

Using either the Adjust horizontal (◀▶) or Adjust vertical (⬆️) knob, select the output video format required by the display: RGB (default), YUV, or RGsB.

Sync Polarity

The display or projector may require a particular combination of horizontal (H) and vertical (V) sync signal polarities. Select the appropriate combination of positive or negative H and V sync by rotating either the Adjust horizontal (◀▶) or Adjust vertical (⬆️) knob.

NOTE *If the previous output signal was specified as RGsB or YUV, this submenu will not be displayed because this menu is only active for RGBHV.*

H Format

For RGBS pass-through input (RGB is selected for Input 4), composite sync is output on the “H” BNC. See “RGB pass-through” under “Rear Panel Features” in this chapter.

To output composite sync on the “H” BNC (for scaled video inputs only, not pass-through), the H Format must be specified as “HV”.

Select either H or HV by rotating either the Adjust horizontal (◄►) or Adjust vertical (⬆️) knob. The default is “H”.

Blanking Configuration

The following flowchart provides an overview of the Blanking submenu and the options for each setting.

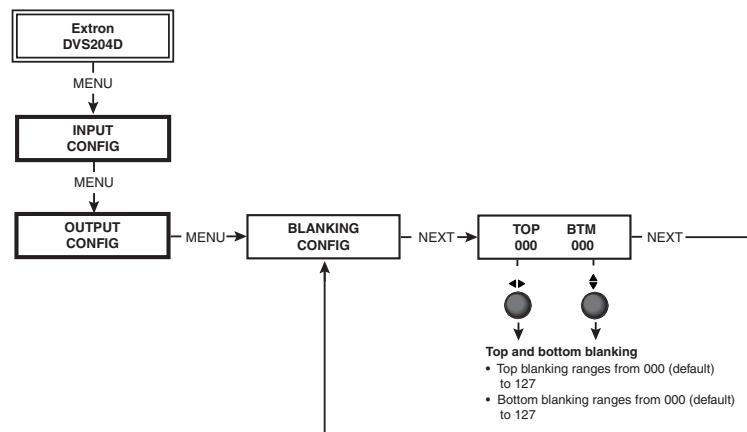

Top and bottom blanking

To remove noise or extraneous material, such as closed captioning, remove scan lines at either the top or bottom of the screen. Rotate the Adjust horizontal (◄►) knob to adjust the top blanking from 0 to 127 lines. The default is 0. Rotate the Adjust vertical (⬆️) knob to adjust the bottom blanking from 0 to 127 lines. The default is 0.

Memory Preset

The following flowchart provides an overview of the Memory Preset submenus and the options for each setting.

NOTE *The presets will only save the Sizing and Centering information, but will not save information for the pass-through input, i.e., RGB at Input 4.*

Installation and Operation, cont'd

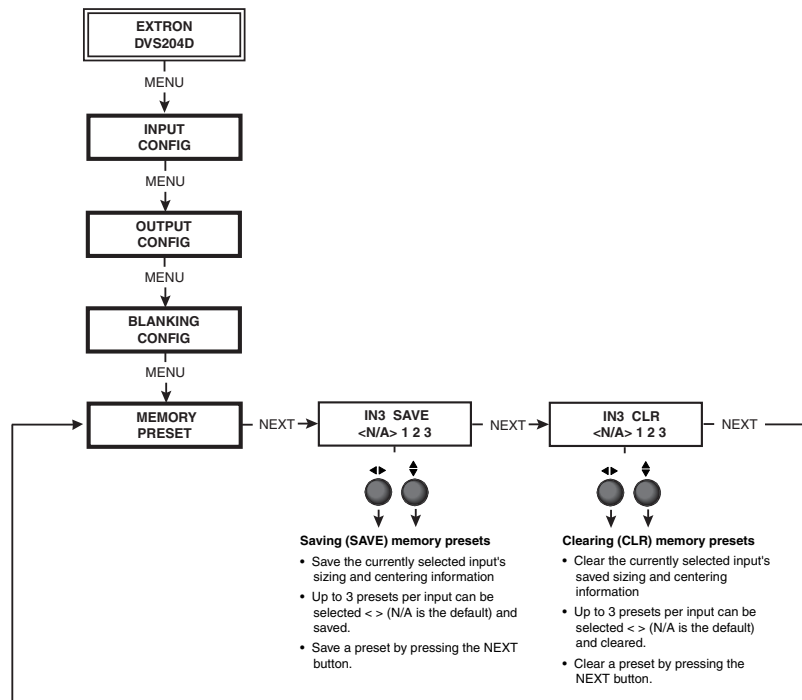

Save (SAVE) memory preset

From this submenu, the sizing and centering information for the currently selected input can be saved to memory. Up to three memory presets can be saved per input.

Using either the Adjust horizontal (◄►) or Adjust vertical (◄◆►) knob, select (< >) either N/A, 1, 2, or 3 to select a preset. The default is <N/A>. To save the preset, press the Next button.

NOTE *The presets will save the Sizing and Centering information in non-volatile memory, so powering down the DVS 204 will not lose the presets. Saving a preset by pressing the Next button will also advance to the next submenu (Clear memory preset).*

Clear (CLR) memory preset

From this submenu, up to three saved presets for the currently selected input can be cleared from memory.

Using either the Adjust horizontal (◄►) or Adjust vertical (◄◆►) knob, select (< >) either N/A, 1, 2, or 3 to select a preset. The default is <N/A>. To clear the preset, press the Next button.

NOTE *Clearing a preset by pressing the Next button will also cause a return to the Memory Preset menu.*

Recalling a preset

Recalling a saved preset requires that the desired input be currently selected and that the input button be pressed successively to activate each saved preset (up to three). Each saved preset will display the LCD message "Input #X Memory Y" where "X" refers to the input (1 to 4) and "Y" refers to the preset (1 to 3).

The absence of any saved presets will not display the "Input #X Memory Y" LCD message for the absent preset.

NOTE *The presets are specific to a selected output rate. If the output rate is subsequently changed, the previously saved preset will have no effect on the video output. However, if the original output rate is later restored for a saved preset, the preset will again apply to that output rate.*

Advanced Configuration

The following flowchart provides an overview of the Advanced Configuration submenus and the options for each setting.

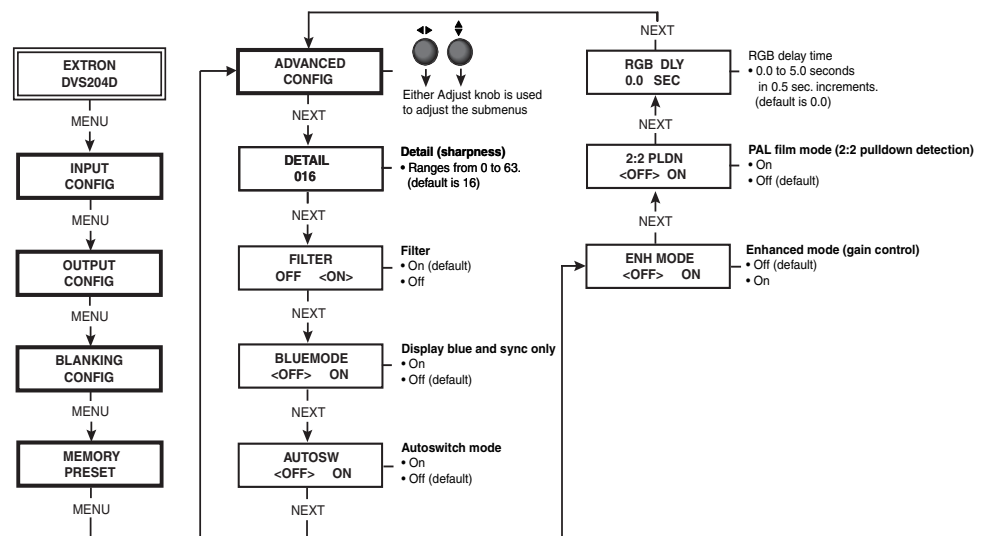

Detail control

This submenu allows adjustment of the image detail (sharpness) of the output display. The adjustment ranges from 0 to 63. The default is 16.

Using either the Adjust horizontal (◀▶) or Adjust vertical (⬆⬇) knob, adjust the detail while observing the output display.

Filter mode

The Filter mode, when set "On", reduces or eliminates aliasing and the resultant "jail bar" effect. For digital displays, set the filter "On" to reduce or eliminate high frequency noise. For CRT output, set the filter "Off".

Use either the Adjust horizontal (◀▶) or Adjust vertical (⬆⬇) knob to specify this mode as "On" or "Off". The default is "On".

Installation and Operation, cont'd

Blue mode

To aid in setup of the scaler's color and tint, the Blue mode can be set from this submenu to "On" so that only sync and blue video signals will be passed to the display.

Use either the Adjust horizontal (◄►) or Adjust vertical (⬆) knob to specify this mode. The default is "Off".

NOTE *The Blue mode will be effective for YUV input signals. YC input signals will pass Y, but not C, so the output display will be black-and-white only.*

Autoswitch (Autosw) mode

The Autoswitch mode causes the highest numbered input that has a signal present to be automatically selected. For example, if both Inputs 1 and 3 have active input signals, Input 3 will be selected.

From this submenu, use either the Adjust horizontal (◄►) or Adjust vertical (⬆) knob to specify this mode as "On" or "Off". The default is "Off".

NOTE *The Autoswitch mode ignores the presence of an SDI input signal, so any input which is assigned an active SDI signal will not be selected.*

Enhanced (Enh) mode

When the Enhanced mode is set "On", automatic gain control of the video input signal is enabled. If the input signal level is too weak, the signal gain will be increased, and if the input signal level is excessive, the signal gain will be decreased.

From this submenu, use either the Adjust horizontal (◄►) or Adjust vertical (⬆) knob to specify this mode as "On" or "Off". The default is "Off".

NOTE *The Enhanced mode will only be effective on composite and S-video input signals.*

2:2 Pulldown detection (PAL Film mode detect) submenu

For the currently selected input, set this feature to "On" if the source is PAL video that originated in film. For standard PAL video sources, such as cameras, set this feature to "Off" (default).

NOTE *This feature does not apply to NTSC video sources since film mode (3:2 pulldown) is automatically detected for those signals.*

From this submenu, use either the Adjust horizontal (◄►) knob or Adjust vertical (⬆) knob to specify this mode as "On" or "Off".

RGB delay (Triple-Action Switching)

With Triple-Action Switching, the DVS 204 switches to the new sync signal before switching RGB (video) signals. RGB delay allows the display device to adjust to the new sync timing after a brief delay (during which the display is blanked) before displaying the new picture, which will appear without glitches. Triple-Action Switching is also known as video mute switching.

Use the Adjust horizontal (◄►) knob or Adjust vertical (⬆) knob to select the blanking period (RGB delay time) from 0 seconds (default) to 5 seconds in 0.5 second steps.

Exit Menu

From this submenu, press the Next button to return to the Default menu cycle, or press the Menu button to return to the Input Configuration menu.

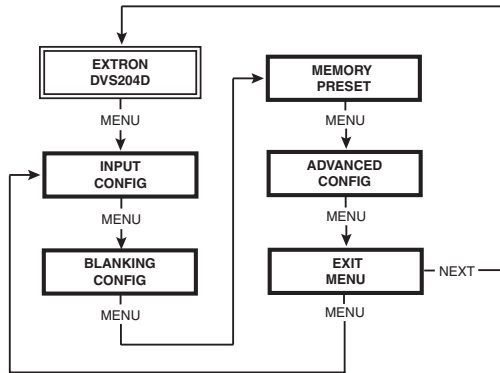

Image Adjustments

Image adjustments apply to scaled video output only; RGB signals are passed through without adjustments. Sizing and centering image adjustments can be stored in memory as a preset (see the “Memory Preset” section in this chapter) and can be set separately for each input.

Color, tint, brightness, contrast, centering, sizing

To adjust an image for color, tint, brightness, contrast, centering, or sizing follow the steps below. An example of making color adjustments, shown in the following flowchart, demonstrates the process, which is similar for all the other image adjustments.

1. Press the input selection button of the input you wish to adjust.
2. Toggle the appropriate image adjustment button (Color/Tint, Brightness/Contrast, Centering, and Sizing). The LCD display will show the name of the adjustments and the value of the current setting.

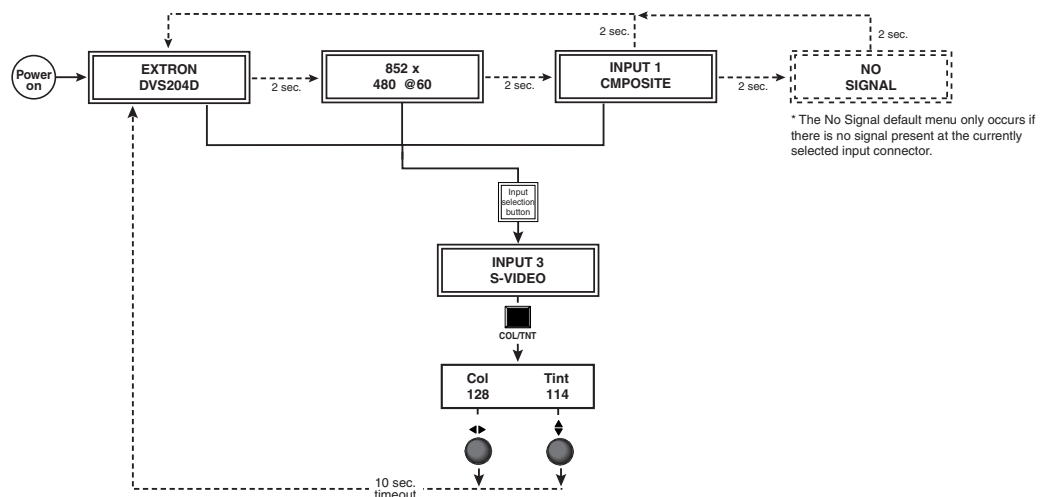

NOTE The Adjust horizontal knob and the Adjust vertical knob are used to adjust the image settings on the left and right sides of the LCD screen, respectively.

Installation and Operation, cont'd

3. Rotate the Adjust horizontal knob (◄►) or Adjust vertical knob (⬆) to select a level from the following adjustment ranges:

NOTE *The Adjust knobs have no mechanical limits to their rotation.*

- Color and Tint (Col/Tnt): 0 to 255 (see note below)
- Brightness and Contrast (Br/Cont): 0 to 255
- Centering (Center): 0 to 255
- Sizing (Size)

Rotating the horizontal Adjustment knob (◄►) clockwise or counterclockwise will increase or decrease, respectively, the horizontal sizing. Rotating the vertical Adjustment knob (⬆) clockwise or counterclockwise will increase or decrease, respectively, the vertical sizing. The visual indicator on the LCD will stop moving when the upper or lower sizing limit has been reached.

The scaler will time-out to the default menu after 10 seconds.

4. Repeat steps 2 and 3 for each image adjustment to be made for that input.

NOTE *The LCD display will indicate that a Tint adjustment is not available (N/A) for Input 2 (component) or Input 4 (RGB, RGBS, RGBcvS).*

Input Reset

Each input of the DVS 204 scaler can be reset to its default centering and sizing values by holding down the specific input button until the Input # Reset message is displayed on the LCD screen.

System Reset

The DVS 204 can be reset to all of its default values by holding down the Input 1 button while simultaneously plugging in the power cord. The System Reset message will be displayed on the LCD screen.

Front Panel Security Lockout (Executive Mode)

To prevent accidental changes to settings, press the Col/Tnt and Center buttons simultaneously for 2 seconds to enable the DVS 204's Executive mode. Executive mode locks all front panel functions. The menu system will still return to the Default menu when 10 seconds have elapsed. The IR 901 will still be able to control the scaler after Executive mode has been enabled. When Executive mode is active, all functions and adjustments can still be made through RS-232 control. For details on RS-232 control, see chapter three.

To disable the Executive mode, press the Col/Tnt and Center buttons simultaneously for 2 seconds.

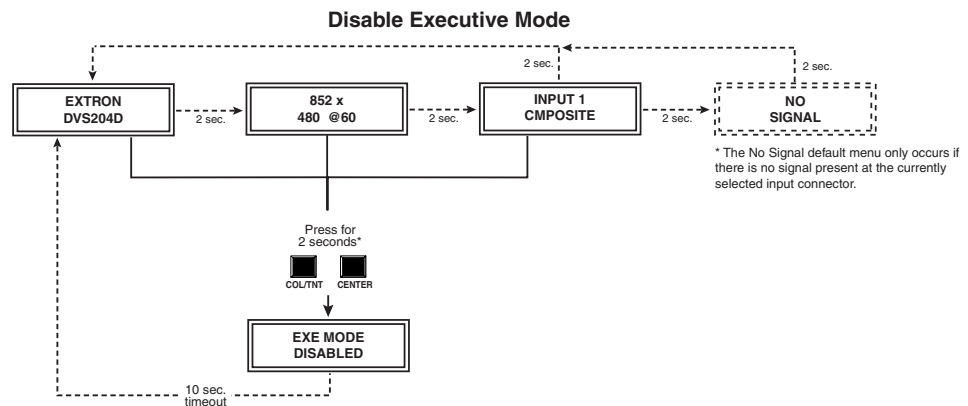
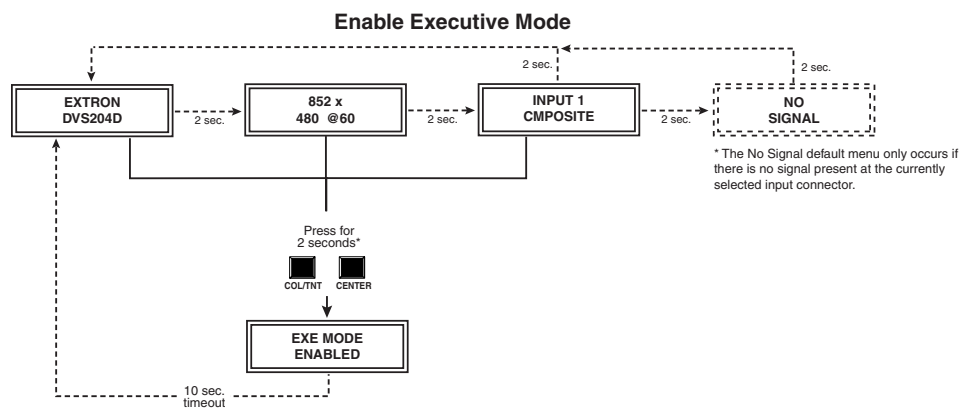

IR 901 Infrared Remote Control

The IR 901, shown at right, replicates all of the front panel controls except the Menu and Next buttons. If Executive mode has been enabled on the DVS 204, input selection and adjustments can still be made from the IR 901. You must use the DVS 204's front panel or the Windows-based control program (via an RS-232 device) to configure and program the scaler. See chapter three, "Serial Communication", for details.

The topmost part of the IR 901 features three Aspect Ratio Preset buttons, a Freeze button and four input selection buttons (1, 2, 3, 4). Inputs 5 and 6, and the Take button are *not* functional. The middle portion of the IR 901 features the size and centering buttons. The bottom part contains the adjustment controls for color, tint, brightness, contrast, and detail adjustments. The sharpness buttons are *not* functional.

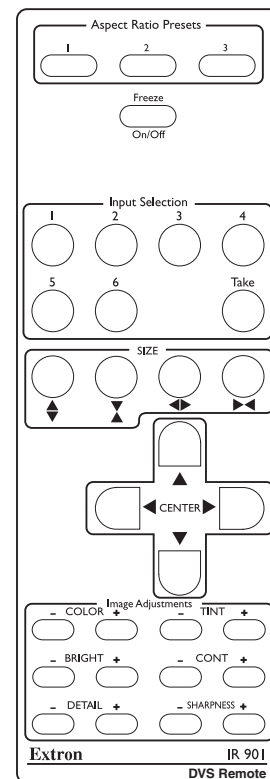

Aspect ratio presets

Up to three saved memory presets of sizing and centering information may be recalled selecting these buttons. See the "Memory Preset" section earlier in this chapter.

Freezing an input

To freeze the input being displayed, press the Freeze On/Off button. To unfreeze the input, press the Freeze button again.

Selecting an input

To select an input source, press an input button (1 through 4).

Size and center

Use the Size and Center buttons to adjust the sizing and centering aspects of a displayed image.

Image adjustments

The color, tint, brightness, contrast, and detail of a displayed image may be increased or decreased by using the appropriate Image Adjustment buttons at the bottom of the IR 901.

Troubleshooting

This section gives recommendations on what to do if you have problems operating the DVS 204, and it provides examples and descriptions for some image problems you might encounter.

The following are some tips to help you in troubleshooting.

1. Some symptoms may resemble others, so you may want to look through all of the examples before attempting to solve the problem.
2. Be prepared to backtrack in case the action taken doesn't solve the problem.
3. It may help to keep notes and sketches in case the troubleshooting process gets lengthy. This will also give you something to discuss if you call for technical support.
4. Try simplifying the system by eliminating components that may have introduced the problem or made it more complicated.
5. For sync-related problems: Portable digital projectors are designed to operate close to the video source. Sync problems may result from using long cables or from improper termination. A sync adapter, such as Extron's ASTA (active sync termination adapter), may help solve these problems.
6. For LCD and DLP projectors and plasma displays: In addition to the sync-related information above, check the user's manual that came with the projector for troubleshooting tips, as well as for settings and adjustments. Each manufacturer may have its own terms, so look for terms like "auto setup", "auto sync", "pixel phase", and "tracking".

Operating problems

The table below shows some common operating problems and their solutions.

Problem	Cause	Solution
No image appears.	The input signal is incompatible.	Attach an input device that is compatible with NTSC 3.58, NTSC 4.43, PAL, or SECAM.
	Freeze mode was entered when the image was black.	Deactivate freeze mode
	The scaled output rate is too high for the display.	Change the scaled output to a compatible resolution.
The image is frozen.	Freeze mode is on.	Deactivate freeze mode. If that does not work, unplug the power cord from the scaler, then plug it back in.
The image is flashing.	The scaled output rate is too high for the display.	Change the scaled output to a compatible resolution.
The image is green.	The output sync is configured for sync on green.	Turn off sync on green.
The image is too soft.	The detail level needs to be changed.	Change the detail level.

Installation and Operation, cont'd



DVS 204

Chapter Three

Serial Communication

RS-232 Programmer's Guide

Control Software for Windows

Serial Communication

The DVS 204 can be remotely controlled via a host computer or other device (such as a control system) attached to the rear panel Remote connector. The control device (host) can use either Extron's Simple Instruction Set (SIS) commands or the graphical control program for Windows.

The scaler uses a protocol of 9600 baud, 1 stop bit, no parity, and no flow control.

The rear panel RS-232 9-pin D connector has the following pin assignments:

Pin	RS-232 function	Description
1	Input #1	Contact closure
2	Tx	Transmit data
3	Rx	Receive data
4	Input #2	Contact closure
5	Gnd	Signal ground
6	Input #3	Contact closure
7	Input #4	Contact closure
8	-	No connection
9	Hardwired IR	IR input

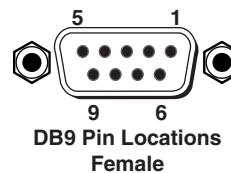

RS-232 Programmer's Guide

Host-to-scaler communications

SIS commands consist of one or more characters per field. No special characters are required to begin or end a command sequence. When the DVS 204 determines that a command is valid, it executes the command and sends a response to the host device. All responses from the scaler to the host end with a carriage return and a line feed (CR/LF = ↵), which signals the end of the response character string. A string is one or more characters.

It is also possible to send several SIS commands back-to-back in sequence.

Scaler-initiated messages

When a local event such as a front panel selection or adjustment takes place, the DVS 204 scaler responds by sending a message to the host. No response is required from the host. The scaler-initiated messages are listed here (underlined).

(C) Copyright 2002, Extron Electronics, DVS 204, Vx.xx ↵

The DVS 204 sends the copyright message when it first powers on. Vx.xx is the firmware version number.

C hn[x] ↵ (where x is the input number)

The DVS 204 sends this response when an input is switched.

Error responses

When the scaler receives a valid SIS command, it executes the command and sends a response to the host device. If the DVS 204 is unable to execute the command because the command is invalid or it contains invalid parameters, it returns an error response to the host.

The error response codes and their descriptions are as follows:

E01 – Invalid input channel number (the number is too large)

E10 – Invalid command

E11 – Invalid preset number

E13 – Invalid value (the number is out of range/too large)

E17 – Illegal command for this signal type.

Using the command/response tables

The command/response tables on the next page list valid command ASCII codes, the scaler's responses to the host, and a description of the command's function or the results of executing the command. Upper and lower case characters may be used interchangeably in the command field.

The ASCII to HEX conversion table at left is for use with the command/response tables.

ASCII to HEX Conversion Table												Esc 1B	CR 0D	LF 0A			
20	!	21	"	22	#	23	\$	24	%	25	&	26	'	27			
(28)	29	*	2A	+	2B	,	2C	-	2D	.	2E	/	2F			
0 30	1	31	2	32	3	33	4	34	5	35	6	36	7	37			
8 38	9	39	:	3A	;	3B	<	3C	=	3D	>	3E	?	3F			
@ 40	A	41	B	42	C	43	D	44	E	45	F	46	G	47			
H 48	I	49	J	4A	K	4B	L	4C	M	4D	N	4E	O	4F			
P 50	Q	51	R	52	S	53	T	54	U	55	V	56	W	57			
X 58	Y	59	Z	5A	[5B	\	5C]	5D	^	5E	_	5F			
` 60	a	61	b	62	c	63	d	64	e	65	f	66	g	67			
h 68	i	69	j	6A	k	6B	l	6C	m	6D	n	6E	o	6F			
p 70	q	71	r	72	s	73	t	74	u	75	v	76	w	77			
x 78	y	79	z	7A	{	7B		7C	}	7D	~	7E	DEL	7F			

ASCII to Hex conversion table

The command/response tables use symbols (defined below) to represent variables.

Symbol definitions

- ↵ = CR/LF (carriage return/line feed) (hex 0D 0A)
- = Space
- Esc** = Escape key
- X1** = Specific input number (0 through 4)
0 = no input
1 = input 1, 2 = input 2, and so forth
- X2** = 0 = off, 1 = on
- X4** = Video signal type (1 through 7)
1 = composite video
2 = YC
3 = YUV
4 = RGB
5 = RGBS
6 = RGBcvS
7 = SDI (serial digital interface)
- X5** = Input (1 to 4)
- X8** = Controller firmware version (listed to two decimal places e.g.: x.xx)
- X10** = Picture adjustment range (0 through 255)
- X11** = Scaler resolution
1 = 640x480
2 = 800x600
3 = 848x480
4 = 852x480
5 = 1024x768
6 = 1280x768
7 = 1280x1024
8 = 1360x765
9 = 1365x1024
10 = 480p
11 = 720p
12 = 1080p
13 = 1080i
14 = 1400x1050
15 = 576p
- X12** = Detected input signal standard (0 through 4)
0 = none
1 = NTSC 3.58
2 = PAL
3 = NTSC 4.43
4 = SECAM
- = not applicable (occurs when the input is set for RGB, YUV, or progressive YUV)
- X13** = Detail level (0 through 63)
- X14** = Adjustment range (0 through 127)
- X16** = Executive mode status (0 through 2)
0 = disabled (executive mode off, normal mode on)
1 = enabled, image adjustments are locked
- X17** = Blanking adjustment range (0 through 127 lines)
- X19** = Input configuration preset (1 through 3)
- X20** = Scaler refresh rate
1 = 50 Hz
2 = 56 Hz (1280x768 only)
3 = 60 Hz
4 = 75 Hz
5 = AFL* (50 Hz for PAL or 59.94 Hz for NTSC)
6 = True rate (72 Hz for NTSC or 100 Hz for PAL)

*NOTE: Lock or AFL is Accu-RATE Frame Lock™

Serial Communication, cont'd

Command/response table for SIS commands

Command	ASCII Command (host to scaler)	Response (scaler to host)	Additional description
Input selection			
Select video input <i>Example:</i>	X5 ! 3!	C X5 ↵ C3 ↵	Video Input X1 . <i>Example:</i> select video Input 3.
Memory preset			
Recall input configuration preset	X19 .	Rpre X19 ↵	Recall input preset X19 .
Save input configuration preset	X19 ,	Spre X19 ↵	Save to input preset X19 .
Input video type (Inputs 2 and 4 only)			
Set video signal type <i>Example:</i>	X5 * X4 \ 2*3\ 2 \	X5 Typ X4 ↵ 2Typ3 ↵ 2Typ3 ↵	Select Input X5 (Inputs 2 and 4 only) and assign it a video type X4 . Video type X4 is defined to be: 1 = video, 2 = S-video, 3 = YUV, 4 = RGB, 5 = RGBS, 6 = RGBcvS, and SDI. For SDI input, substitute X5 with X1 where the SDI input can be assigned to Input X1 (0, 1, 2, 3, or 4 with 0 meaning there is no SDI input). <i>Example:</i> set Input 2 to 3 (YUV) <i>Example:</i> show Input 2 video type = 3.
View the video signal type <i>Example:</i>	X5 \ 2 \	X5 Typ X4 ↵ 2Typ3 ↵	Show the video signal type. <i>Example:</i> show Input 2 video type = 3.
Color			
Set a specific color value <i>Example:</i>	X10 C 47C	Col X10 ↵ Col047 ↵	Specify a color adjustment level. <i>Example:</i> set the color adjustment to 47.
Increment	+C	Col X10 ↵	Increase color adjustment level.
Decrement	-C	Col X10 ↵	Decrease color adjustment level.
View the color value	C	Col X10 ↵	Show the color adjustment.
Tint			
Set a specific tint value <i>Example:</i>	X10 T 176T	Tin X10 ↵ Tin176 ↵	Specify a tint adjustment level. <i>Example:</i> set the tint to 176.
Increment	+T	Tin X10 ↵	Increase tint adjustment level.
Decrement	-T	Tin X10 ↵	Decrease tint adjustment level.
View the tint value	T	Tin X10 ↵	Show the tint adjustment.
Contrast			
Set a specific contrast value	X10 ^	Con X10 ↵	Specify the contrast adjustment.
Increment	+^	Con X10 ↵	Increase the contrast.
Decrement	-^	Con X10 ↵	Decrease the contrast.
View the contrast value	^	Con X10 ↵	Show the contrast setting.
Brightness			
Set a specific value	X10 Y	Brn X10 ↵	Specify the brightness adjustment.
Increment	+Y	Brn X10 ↵	Increase the brightness.
Decrement	-Y	Brn X10 ↵	Decrease the brightness.
View the brightness value	Y	Brn X10 ↵	Show the brightness setting.
Detail mode			
Set the detail level	X13 D	Det X13 ↵	Specify the detail level.
View the detail value	D	Det X13 ↵	Show the detail setting.
Increment	+D	Det X13 ↵	Increase detail level.
Decrement	-D	Det X13 ↵	Decrease detail level.

Command/response table for SIS commands (continued)

Command	ASCII Command (host to scaler)	Response (scaler to host)	Additional description
Horizontal shift			
Set horizontal position	$\boxed{X10}$ H	Hph $\boxed{X10}$ ↵	Specify the horizontal position.
Increment	+H	Hph $\boxed{X10}$ ↵	Shift right.
Decrement	-H	Hph $\boxed{X10}$ ↵	Shift left.
View the horizontal pos. value	H	Hph $\boxed{X10}$ ↵	Show the horizontal position.
Vertical shift			
Set the vertical position	$\boxed{X10}$ /	Vph $\boxed{X10}$ ↵	Specify the vertical position.
Increment up	+ /	Vph $\boxed{X10}$ ↵	Shift up.
Increment down	- /	Vph $\boxed{X10}$ ↵	Shift down.
View the vertical pos. value	/	Vph $\boxed{X10}$ ↵	Show the vertical position.
Horizontal size			
Increase the horizontal size	+:	Hsz + ↵	Widen the picture.
Decrease the horizontal size	-:	Hsz - ↵	Make the picture narrower.
Vertical size			
Increase the vertical size	+;	Vsz + ↵	Make the picture taller.
Decrease the vertical size	-;	Vsz - ↵	Make the picture shorter.
Top blanking			
Specify a top blanking value	$\boxed{X17}$ (Blt $\boxed{X17}$ ↵	Set the number of lines to blank at the top of the picture.
Increase the top blanking value	+ (Blt $\boxed{X17}$ ↵	Increase the # of top lines blanked.
Decrease the top blanking value	- (Blt $\boxed{X17}$ ↵	Decrease the # of top lines blanked.
View the top blanking value	(Blt $\boxed{X17}$ ↵	Show the number of lines that are blanked at the top of the picture.
Bottom blanking			
Specify a bottom blanking value	$\boxed{X17}$)	Blb $\boxed{X17}$ ↵	Set the number of lines to blank at the bottom of the picture.
Increase the bottom blanking value	+)	Blb $\boxed{X17}$ ↵	Increase the number of lines blanked at the bottom.
Decrease the bottom blanking value	-)	Blb $\boxed{X17}$ ↵	Decrease the number of bottom lines blanked.
View the bottom blanking value)	Blb $\boxed{X17}$ ↵	Show the # of bottom lines that are blanked.
Scaler rate			
Set the output rate	$\boxed{X11}$ * $\boxed{X20}$ =	Rte $\boxed{X11}$ * $\boxed{X20}$ ↵	Select a scaler output scan rate.
View the output rate	=	Rte $\boxed{X11}$ * $\boxed{X20}$ ↵	Show the scaler output rate.
Video mute			
Mute on	1B	Vmt $\boxed{X2}$ ↵	Mute video output.
<i>Example:</i>	1B	Vmt1 ↵	
Mute off	0B	Vmt $\boxed{X2}$ ↵	Unmute video output.
View video mute status	B	Vmt $\boxed{X2}$ ↵	Show the status of video mute.

Serial Communication, cont'd

Command/response table for SIS commands (continued)

Command	ASCII Command (host to scaler)	Response (scaler to host)	Additional description
Freeze			
Enable	1F	Frz1 ↵	Output a "frozen" video image.
Disable	0F	Frz0 ↵	Turn off freeze (output motion).
View the freeze status	F	Frz X2 ↵	Show the freeze status.
<i>Example:</i>	F	Frz0 ↵	
Front panel security lockout (Executive mode)			
Disable	0X	Exe0 ↵	Adjustments & selections can be made from the front panel.
Enable (lock image adjustments)	1X	Exe1 ↵	Lock front panel adjustments; adjust image via RS-232 only.
View the executive mode status	X	Exe X16 ↵	Show executive mode status.
<i>Example:</i>	X	Exe0 ↵	
Firmware version, part number & information requests			
Query firmware version number	Q	Ver X8 ↵	Show the controller firmware version.
Request part number	N	N60-442-0_ ↵	Show the scaler's part #.
Request general info.	I	(See below) C X1 • Typ X4 • Std X12 • Pre X19 • Sdi X1 ↵	Show the scaler's status.
Zap (reset to default settings)			
Zap image adjustments/controls	Esc zI	ZapI ↵	Reset the image adjustments to factory settings.
Zap all DVS 204 settings/memories	Esc zXXX	ZapXXX ↵	Reset everything; all settings and adjustments to the factory default.

The syntax for setting a special function is $X? * X! \#$ where $X?$ is the function number and $X!$ is the value. To view a function's setting, use $X? \#$ where $X?$ is the function number. In the following table the values of the $X?$ variable are different for each command/function. These values are given in the rightmost column.

Command/response table for special function SIS commands

Command	ASCII Command (host to scaler)	Response (scaler to host)	$X!$ values and additional descriptions
Enhanced mode			
Enhanced mode	12 * $X!$ #	Enh $X!$ ↵	0 = off, 1 = on,
<i>Example:</i>	12*1#	Enh1 ↵	<i>Example:</i> enable enhanced mode.
Scaler settings			
Output signal	6 * $X!$ #	Syn $X!$ ↵	0 = RGB 1 = YUV 2 = RGSB (sync on green, SOG)
<i>Example:</i>	6*0#	Syn0 ↵	<i>Example:</i> RGB sync output
Scaler output polarity	7 * $X!$ #	Pol $X!$ ↵	0 = H-/V- (default) 1 = H-/V+ 2 = H+/V- 3 = H+/V+
<i>Example:</i>	7*1#	Pol1 ↵	<i>Example:</i> H-/V+ sync polarity
Blue screen			
Blue screen (blue & sync output only)	8* $X!$ #	Blu $X!$ ↵	0 = off (default) (RGB & sync output) 1 = on (blue video & sync output only)
<i>Example:</i>	8*1#	Blu1 ↵	<i>Example:</i> blue & sync output for setup.
Auto switch			
Auto switch mode	10* $X!$ #	Aut $X!$ ↵	0 = off (default), 1 = on
<i>Example:</i>	10*1#	Aut1 ↵	<i>Example:</i> enable auto switch mode.
Reconstruction filter			
Reconstruction filter	11* $X!$ #	Fil $X!$ ↵	0 = off, 1 = on (default)
<i>Example:</i>	11*1#	Fil1 ↵	<i>Example:</i> enable the reconstruction filter.
PAL Film mode (2:2 pulldown detection)			
PAL film mode detection	18* $X!$ #	Flm $X!$ ↵	0 = off (default), 1 = on
<i>Example:</i>	18*1#	Flm1 ↵	<i>Example:</i> enable PAL film mode. detection
H Format (sync output format for "H" connector)			
RGSB H format	15* $X!$ #	HFm $X!$ ↵	0 = H – horizontal sync (default) 1 = HV – composite sync
<i>Example:</i>	15*1#	HFm1 ↵	<i>Example:</i> Output composite sync on "H" connector. See "H Format" and "RGB pass-through" sections in chapter two for a complete description of this function.
RGB delay times			
RGB delay	3 * $X!$ #	RGB $X!$ ↵	0 = 0.0 seconds (default), 1 = 0.5 seconds, 2 = 1.0 seconds, ... in ½ second steps up to 10 = 5.0 seconds
<i>Example:</i>	3*7#	RGB07 ↵	<i>Example:</i> 3.5 second RGB delay

Serial Communication, cont'd

Control Software for Windows

The included Extron DVS 204 Control Program for Windows offers another way to control the DVS 204 via RS-232 connection in addition to the Simple Instruction Set commands. The control program's graphical interface includes the same functions as those on the scaler's front panel and some additional features that are only available through the Windows-based software.

The control software is compatible with Windows 95/98, Windows NT, and Windows 2000. Extron's DVS 204 Control Program is included with the scaler, and updates can be downloaded from the Extron Web site (<http://www.extron.com>).

Installing the software

The control program is contained on a set of 3.5-inch diskettes, and it requires approximately 2 MB (megabytes) of hard disk space.

To install the software on the hard drive:

1. Run SETUP.EXE from the floppy disk.
2. Follow the instructions that appear on the screen.

By default the installation creates a C:\DVS 204 directory, and it places two icons (DVS 204 Control Pgm and DVS 204 Help) into a group or folder named "Extron Electronics".

Using the control program

Many items found in the DVS 204 Control Program are also accessible via front panel controls and the LCD menus described in chapter two. Refer to chapter two for details on features and settings. The DVS 204 Help Program provides information on settings and on how to use the control program itself. Some features, including the miscellaneous options, are only available via this control program. These features are described in the sections of this chapter that correspond to the parts of the control program where the features are found.

1. To run the control program, double-click on the DVS 204 Control Pgm icon in the Extron Electronics group or folder. The Comm menu appears on the screen.
2. Click on the comm port that is connected to the DVS 204's RS-232 port. The Extron DVS 204 Control Program windows appear.

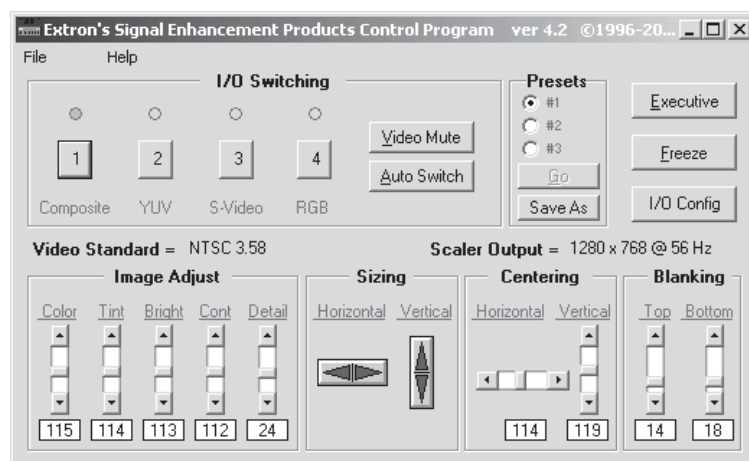

3. Click on the I/O Config button to configure the inputs from the I/O Configuration Window.

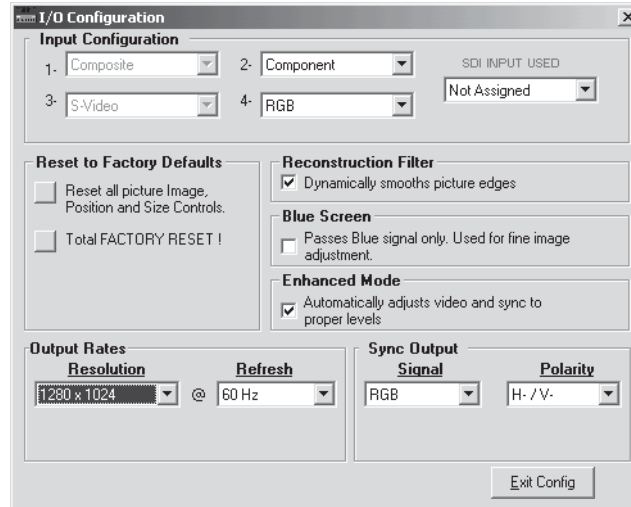

Using the help program

For information on program features, press the F1 computer key, or click on the Help menu from within the DVS 204 Control Program, or double-click on the DVS 204 Help icon in the Extron Electronics group or folder.



For explanations of buttons or functions, click on the tabs in the help screen to reach the desired screen. Use a mouse or the Tab and Enter keys to select a button/function. A description and tips on using the program will appear on screen.

Serial Communication, cont'd



DVS 204

A

Appendix

Appendix

Specifications

Part Numbers and Accessories

Firmware Upgrade Installation

Serial Digital Interface (SDI) Card Installation

Appendix

Specifications

Video input

Number/signal type	1 (RGBHV, RGBS, RGsB) pass-through, RGBS, RGBcvS 1 composite video, S-video, component video (Y, R-Y, B-Y) 1 S-video, 1 SDI (optional, DVS 204D only) 1 composite video
Connectors	(1) 15-pin HD female RGB pass-through, RGBS, RGBcvS 3 BNC female component video, S-video, composite video 1 BNC female SDI (DVS 204D, DVS 204D 12 V only) (1) 4-pin mini DIN female S-video 1 BNC female composite video
Nominal level	1 Vp-p for Y of component video and S-video, and for composite video 0.7 Vp-p for RGB and for R-Y and B-Y of component video 0.3 Vp-p for C of S-video
Minimum/maximum levels	Analog: 0.0 V to 1.0 Vp-p with no offset
Impedance	75 ohms
Horizontal frequency	NTSC 3.58, NTSC 4.43, PAL, SECAM
Vertical frequency	NTSC 3.58, NTSC 4.43, PAL, SECAM
Resolution range	NTSC 3.58, NTSC 4.43, PAL, SECAM
Return loss	<-30 dB @ 5 MHz
DC offset (max. allowable)	1.5 V

Video processing

Decoder	9 bit digital
Digital sampling	24 bit, 8 bits per color; 13.5 MHz standard
Colors	16.78 million

Video output

Number/signal type	1 scaled or pass-through RGBHV, RGBS, RGsB; or scaled component video (Y, R-Y, B-Y)
Connectors	6 female BNC 1 female 15-pin HD
Nominal level	1 Vp-p for Y of component video 0.7 Vp-p for RGB and for R-Y and B-Y of component video
Minimum/maximum levels	0.0 V to 0.7 Vp-p
Impedance	75 ohms
Scaled resolutions	640x480 ^{1,3,4,5,6} , 800x600 ^{1,3,4,5,6} , 848x480 ^{1,3,4,5,6} , 852x480 ^{1,3,4,5,6} , 1024x768 ^{1,3,4,5,6} , 1280x768 ^{2,5,6} , 1280x1024 ^{1,3,4,5,6} , 1360x765 ^{1,3,4,5,6} , 1365x1024 ^{1,3,4,5,6} , 1400x1050 ^{1,3,4,5,6} , HDTV 480p ^{3,5} , 576p ^{1,5} , 720p ^{3,5} , 1080p ^{3,5} , and 1080i ^{1,3,5} ¹ = at 50 Hz ² = at 56 Hz ³ = at 60 Hz ⁴ = at 75 Hz ⁵ = locked to the current input's vertical refresh rate (Accu-RATE Frame Lock) ⁶ = True Rate

Sync

Input type	(RGBHV, RGBS, RGsB) pass-through, RGBS, RGBcvS
Output type	RGBHV, RGBS, RGsB
Standards	NTSC 3.58, NTSC 4.43, PAL, SECAM
Input level	0 V to 1.0 Vp-p
Output level	TTL: 5.0 Vp-p, unterminated
Input impedance	75 ohms

Output impedance	75 ohms
Max input voltage	5 Vp-p
Max. propagation delay	20 ns
Polarity	Positive or negative (switch-selectable)

Control/remote — decoder/scaler

Serial control port	RS-232, 9-pin female D connector
Baud rate and protocol	9600 baud, 8 data bits, 1 stop bit, no parity
Serial control pin configurations	1 = input 1 select 2 = TX 3 = RX 4 = input 2 select 5 = GND 6 = input 3 select 7 = input 4 select 8 = n/a 9 = hardwired IR
Contact closure	9-pin female D connector (same as RS-232 connector)
Contact closure pin configurations	See pins 1, 4, 6, and 7 above.
IR controller module	Extron IR 901 (optional)
Program control	Extron's control/configuration program for Windows® Extron's Simple Instruction Set (SIS™)

General

Power

DVS 204, DVS 204D	100VAC to 240VAC, 50/60 Hz, 30 watts, internal, autoswitchable
DVS 204/204D 12VDC	100VAC to 240VAC, 50/60 Hz, 36 watts, external, autoswitchable; to 12 VDC, 3 A power supply. Product requires 2 A.

Temperature/humidity

All models	Storage: -40 to +158 °F (-40 to +70 °C) / 10% to 90%, noncondensing
DVS 204, DVS 204D	Operating: +32 to +113 °F (0 to +45 °C) / 10% to 90%, noncondensing
DVS 204/204D 12VDC	Operating: +32 to +122 °F (0 to +50 °C) / 10% to 90%, noncondensing

Rack mount Yes, with optional rack shelf, part #60-190-01

Enclosure type Metal

Enclosure dimensions 1.75" H x 8.75" W x 9.5" D (1U high, half rack wide)
4.4 cm H x 22.2 cm W x 24.1 cm D
(Depth excludes connectors and knobs. Width excludes rack ears.)

Product weight 3.3 lbs (1.5 kg)

Shipping weight 6 lbs (3 kg)

Vibration ISTA 1A in carton (International Safe Transit Association)

Listings UL, CUL

Compliances CE, FCC Class A, VCCI, AS/NZS, ICES

MTBF 30,000 hours

Warranty 3 years parts and labor

NOTE All nominal levels are at $\pm 10\%$.

NOTE Specifications are subject to change without notice.

Appendix, cont'd

Part Numbers and Accessories

Included parts

These items are included in each order for a DVS 204 scaler:

Included parts	Part number
DVS 204, 204 D, 204 12V, 204 D 12V (1)	60-442-01, -02, -11, -12
Rubber feet (self-adhesive) (4)	25-020-02
IEC power cord	
Tweezer (small screwdriver)	
DVS 204 User's Manual	
DVS 406 Windows-based control program	

Accessories

These items can be ordered separately:

Accessories	Part number
IR 901 remote control	70-152-01
Rack shelf mounting kit	60-190-01
SDI video input card	70-168-01

Firmware Upgrade Installation

In some cases, the DVS 204's firmware may require replacement with an updated version. There are three user-replaceable firmware chips: U41 — the main microcontroller, U38, and U17. The numbers are printed on the circuit board. We recommend that you send the unit to Extron for service and updates.

WARNING *Changes to firmware must be performed by authorized service personnel only. Some DVS 204 firmware updates must be performed at the Extron factory.*

Follow these steps to replace firmware in the scaler.

1. Disconnect the AC or 12 VDC power cord from the DVS 204 to remove power from the unit.

WARNING *To prevent electric shock or damage, always unplug the DVS 204 scaler from the AC or DC power source before opening the enclosure.*

2. Remove the scaler from the rack or furniture.
3. Remove the cover of the scaler (the top half of the enclosure) by removing the screws, then lifting the cover straight up.

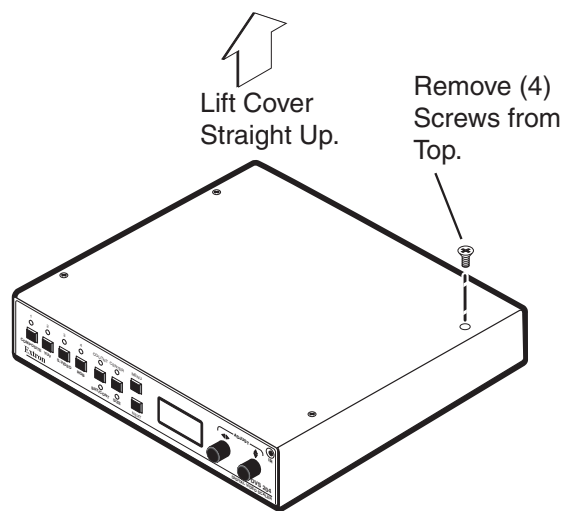

WARNING *Do not touch any switches or other electronic components inside the scaler. Doing so could damage the scaler. Electrostatic discharge (ESD) can damage IC chips even though you cannot feel it. You must be electrically grounded before proceeding with firmware replacement. A grounding wrist strap is recommended.*

4. Locate the firmware chip(s) to be replaced on the circuit board, as shown in the following illustration.

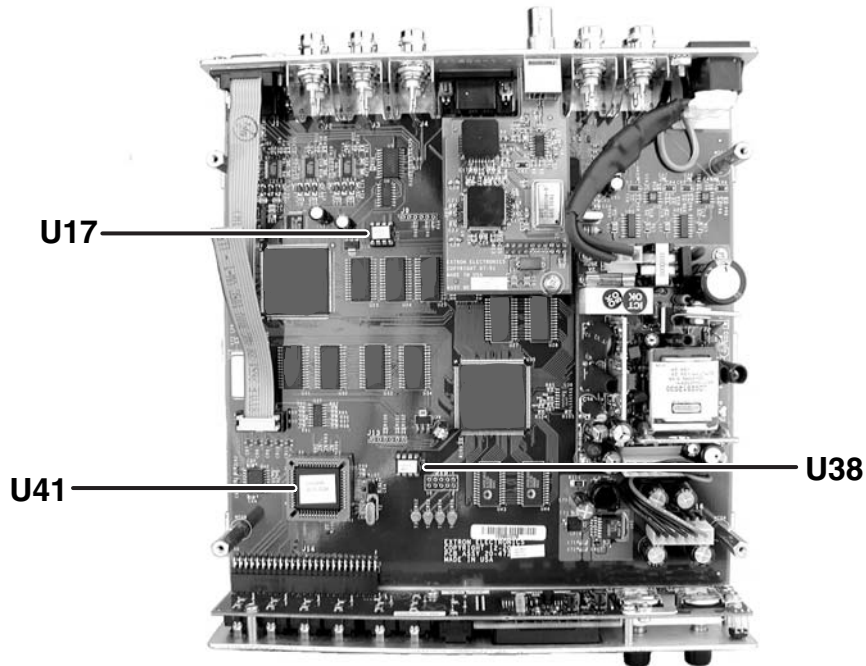

Locating the three firmware IC chips

5. After you are electrically grounded, the U17 IC chip or U38 IC chip may be removed by grasping it firmly with your fingers and pulling it out, then continuing to step 8.

Removal of the U41 IC chip requires a PLCC IC puller tool. To remove the U41 chip, align the hooks of a PLCC IC puller tool with the slots located in opposite ends of the U41 firmware chip.

6. Insert the hooks into the slots, and squeeze the tool gently to grasp the chip.
7. Pull the chip straight out of the socket, and set it aside.
8. For U17 and U38, align the notch of the new firmware chip with the notch of the socket in the same orientation as the old chip.

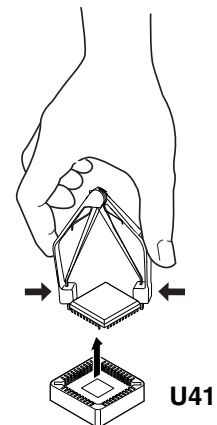
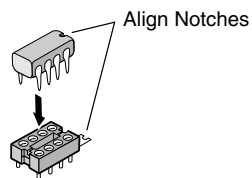

- For U41, align the angled corner of the firmware chip with the angled corner of the socket.
9. Gently, but firmly, press the chip into place in the socket.
 10. Replace the top cover on the DVS 204 scaler, and fasten it with the screws that were removed in step 3.
 11. Rack/furniture mount the scaler, and reconnect the AC or DC power cord.

Serial Digital Interface (SDI) Card Installation

The optional SDI card may be installed in the scaler if it does not already have an input for a serial digital interface signal. We recommend that you send the unit in to Extron for service and updates.

WARNING *Changes to electronic components must be performed by authorized service personnel only.*

Follow these steps to install an SDI card in the DVS 204.

1. Disconnect the AC or DC power cord from the DVS 204 to remove power from the unit.

WARNING *To prevent electric shock, always unplug the DVS 204 scaler from the AC power source before opening the enclosure.*

2. Remove the scaler from the rack or furniture.
3. Remove the cover of the scaler (the top half of the enclosure) by removing the screws, then lifting the cover straight up. See the top cover removal diagram in the "Firmware Upgrade Installation" section.

WARNING *Do not touch any switches or other electronic components inside the scaler. Doing so could damage the scaler. Electrostatic discharge (ESD) can damage IC chips even though you cannot feel it. You must be electrically grounded before proceeding with any electronic component replacement. A grounding wrist strap is recommended.*

4. Locate the SDI card standoff located near the middle rear portion of the main circuit board (looking from above with the front panel nearest to you).

SDI connector opening

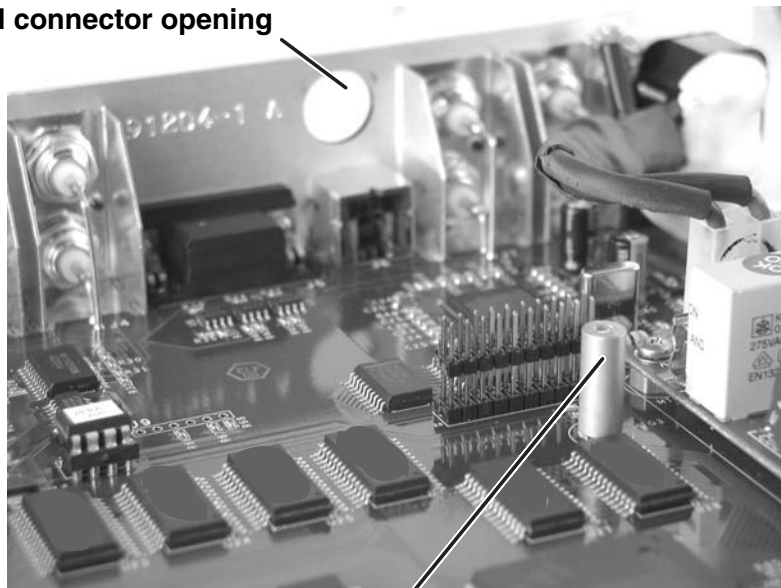

SDI card standoff

5. Remove the adhesive SDI cover from the rear SDI connector opening of the scaler and position the SDI card at an angle with the SDI connector protruding from the rear SDI connector opening.
6. The SDI card has a 20-pin socket on the underside which should align with the 20 pins on the main circuit board. Be sure to align the pins properly, in

Appendix, cont'd

order to prevent bending the pins, before pressing the SDI card firmly in place against the standoff. The mounting hole on the SDI card should now be directly over the standoff.

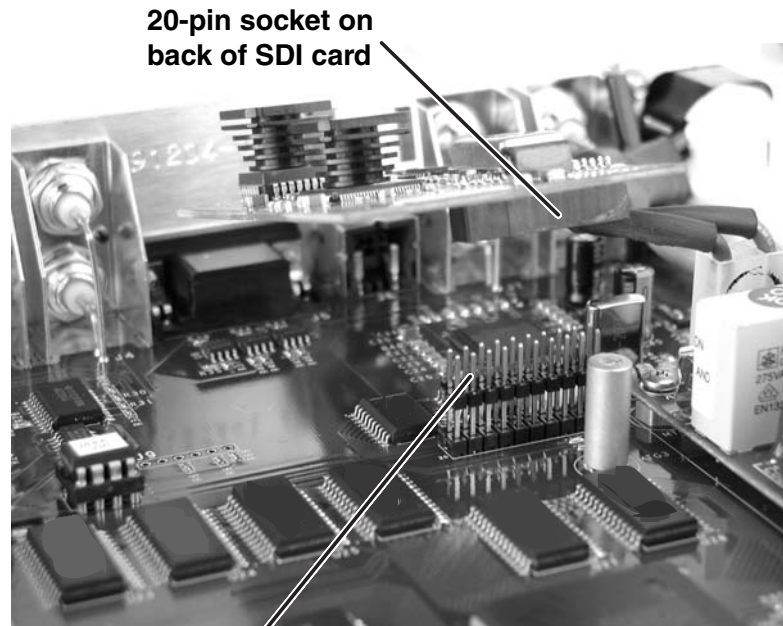

**20-pin connector
on main board**

7. Insert the card's installation screw through the SDI card's mounting hole and gently tighten it into the standoff.

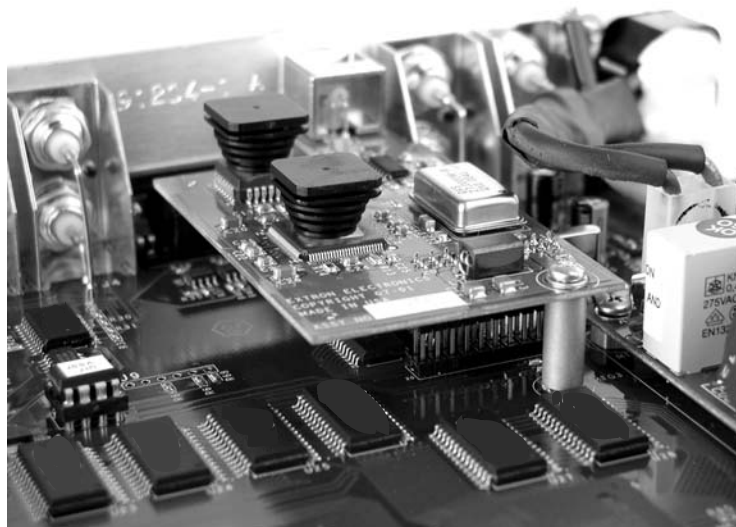

8. Install the SDI connector's hex nut and keep the SDI card from twisting as the nut is tightened.
9. Replace the top cover on the DVS 204 scaler, and fasten it with the screws that were removed in step 3.
10. Rack/furniture mount the scaler, and reconnect the AC power cord.

FCC Class A Notice

Note: This equipment has been tested and found to comply with the limits for a Class A digital device, pursuant to part 15 of the FCC Rules. These limits are designed to provide reasonable protection against harmful interference when the equipment is operated in a commercial environment. This equipment generates, uses and can radiate radio frequency energy and, if not installed and used in accordance with the instruction manual, may cause harmful interference to radio communications. Operation of this equipment in a residential area is likely to cause harmful interference, in which case the user will be required to correct the interference at his own expense.

Note: This unit was tested with shielded cables on the peripheral devices. Shielded cables must be used with the unit to ensure compliance.

Extron's Warranty

Extron Electronics warrants this product against defects in materials and workmanship for a period of three years from the date of purchase. In the event of malfunction during the warranty period attributable directly to faulty workmanship and /or materials, Extron Electronics will, at its option, repair or replace said products or components, to whatever extent it shall deem necessary to restore said product to proper operating condition, provided that it is returned within the warranty period, with proof of purchase and description of malfunction to:

**USA, Canada, South America,
and Central America:**

Extron Electronics
1230 South Lewis Street
Anaheim, CA 92805, USA

Europe, Africa, and the Middle East:

Extron Electronics, Europe
Beeldschemweg 6C
3821 AH Amersfoort
The Netherlands

Asia:

Extron Electronics, Asia
135 Joo Seng Road, #04-01
PM Industrial Bldg.
Singapore 368363

Japan:

Extron Electronics, Japan
Kyodo Building
16 Ichibancho
Chiyoda-ku, Tokyo 102-0082
Japan

This Limited Warranty does not apply if the fault has been caused by misuse, improper handling care, electrical or mechanical abuse, abnormal operating conditions or non-Extron authorized modification to the product.

If it has been determined that the product is defective, please call Extron and ask for an Applications Engineer at (714) 491-1500 (USA), 31.33.453.4040 (Europe), 65.6383.4400 (Asia), or 81.3.3511.7655 (Japan) to receive an RA# (Return Authorization number). This will begin the repair process as quickly as possible.

Units must be returned insured, with shipping charges prepaid. If not insured, you assume the risk of loss or damage during shipment. Returned units must include the serial number and a description of the problem, as well as the name of the person to contact in case there are any questions.

Extron Electronics makes no further warranties either expressed or implied with respect to the product and its quality, performance, merchantability, or fitness for any particular use. In no event will Extron Electronics be liable for direct, indirect, or consequential damages resulting from any defect in this product even if Extron Electronics has been advised of such damage.

Please note that laws vary from state to state and country to country, and that some provisions of this warranty may not apply to you.



Extron Electronics, USA
1230 South Lewis Street
Anaheim, CA 92805
USA
714.491.1500
Fax 714.491.1517

Extron Electronics, Europe
Beeldschemweg 6C
3821 AH Amersfoort
The Netherlands
+31.33.453.4040
Fax +31.33.453.4050

Extron Electronics, Asia
135 Joo Seng Road, #04-01
PM Industrial Building
Singapore 368363
+65.6383.4400
Fax +65.6383.4664

Extron Electronics, Japan
Kyodo Building
16 Ichibancho
Chiyoda-ku, Tokyo 102-0082 Japan
+81.3.3511.7655
Fax +81.3.3511.7656