

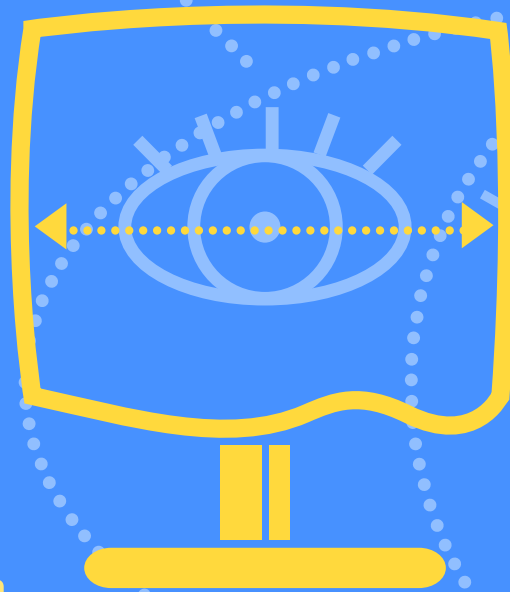

IBM



**9516 - BXX Multimode
TFT LCD Color Monitor**

User's Setup Guide

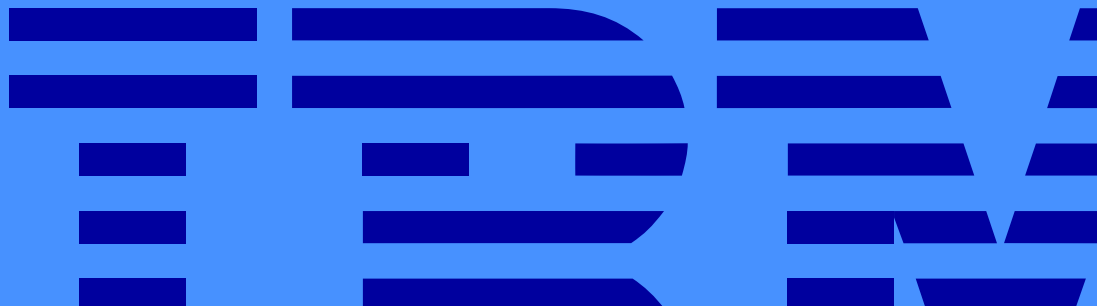

These user's setup instructions cover typical user environments. The on-screen messages may differ depending on the level of your hardware and software. In some cases you may need to vary the setup procedures.

For more information, refer to your computer or operating system manuals or consult your system administrator or dealer.

Ces instructions de configuration d'exploitation s'appliquent aux environnements d'utilisation types. Les messages affichés à l'écran peuvent varier en fonction du niveau de votre matériel et de vos logiciels informatiques. Dans certains cas, vous pouvez être amenés à changer de procédures de configuration.

Pour de plus amples informations à ce sujet, veuillez vous reporter aux manuels de votre ordinateur et de votre système d'exploitation, ou consultez l'administrateur de votre système ou votre revendeur.

Diese Anweisungen für die Einstellung durch den Benutzer gelten für typische Betriebsumgebungen. Die Bildschirmmeldungen können je nach Art der verwendeten Hardware und Software auch anders lauten. In einigen Fällen müssen die Einstellungsschritte unter Umständen abgeändert werden.

Weitere Informationen finden Sie im Computer- oder Betriebssystemhandbuch, oder wenden Sie sich an Ihren Systemadministrator oder Fachhändler.

En estas instrucciones de configuración se describen entornos de usuarios típicos. Los mensajes en pantalla, pueden diferir según sea el nivel del hardware y del software. En algunos casos, necesitará seguir otros procedimientos para la configuración.

Para obtener más información, puede consultar los manuales del ordenador o del sistema operativo o ponerse en contacto con el administrador del sistema o con el distribuidor.

Queste istruzioni di configurazione per l'utente coprono gli ambienti operativi comuni. I messaggi che appaiono sul video possono differire a seconda dell'hardware e del software utilizzati. In alcuni casi potrebbe essere necessario variare le procedure di configurazione.

Per ulteriori informazioni, fare riferimento ai manuali del computer o del sistema operativo, o consultare il proprio amministratore di sistema o il concessionario.

DANGER

To avoid electric shock hazard:

- The product is supplied with a grounded plug and power cord which should be used to connect to the AC supply.
- The power cord should only be used with a properly wired and grounded power outlet.
- Any equipment to which this product is attached must also be connected to a properly wired and grounded outlet.
- Do not remove the covers.
- The product does not incorporate an AC power switch. To isolate the monitor from the electrical supply, you must remove the plug from the power outlet. The power outlet should be easily accessible
- Do not connect or disconnect this product during an electrical storm.
- Always use the AC adapter supplied with the monitor.

Handling:

- Handle this product with care when moving it.
- The panel should not be operated in a horizontal position.
- The fluorescent lamp used in the Liquid Crystal Display assembly contains a small quantity of mercury (less than 50 milligrams). For environmental reasons this product should not be disposed of into landfill. It must be disposed of as required by local ordinances or regulations.
- The Liquid Crystal Display assembly is made of glass and can break as a result of rough handling or dropping. This may lead under some circumstances to a small quantity of the liquid crystal material being exposed. Avoid contact with this material as it is an irritant. Should this material come into contact with eyes, hands, etc., the area should be washed with water for at least 15 minutes; medical care should be obtained if any symptoms are present after washing.

DANGER

Pour éviter tout risque d'électrocution :

- Le produit est livré avec un cordon d'alimentation et une prise de terre à utiliser pour le branchement sur le secteur (VCA).
- Le cordon d'alimentation ne doit être branché que sur une prise électrique correctement câblée et mise à la terre.

- Tous les matériels auxquels ce produit est raccordé doivent également être branchés sur une prise électrique correctement câblée et mise à la terre.
- Ne pas enlever les capots de protection.
- Le produit ne possède aucun interrupteur de courant électrique (VCA). Pour isoler le moniteur de l'alimentation électrique, débrancher la fiche de la prise électrique. La prise électrique doit être facilement accessible.
- Ne pas brancher ou débrancher ce produit pendant un orage électrique.
- Toujours utiliser l'adaptateur électrique (VCA) fourni avec le moniteur.

Manipulation :

- Manipuler ce produit avec précaution pour le déplacer.
- Le panneau ne doit pas être utilisé en position horizontale.
- La lampe fluorescente de l'écran à cristaux liquides contient une faible quantité de mercure (moins de 50 milligrammes). Pour protéger l'environnement, ce produit ne doit pas être jeté dans une décharge. Il doit être éliminé conformément aux réglementations locales.
- L'écran à cristaux liquides est en verre. Il peut donc se briser en cas de chute ou de mauvaise manipulation. Si l'écran est brisé, une faible quantité de cristaux liquides risque de se répandre. Éviter tout contact avec cette matière irritante. Si des cristaux liquides rentrent en contact avec les yeux, les mains, etc., il faut alors laver cette zone avec de l'eau pendant au moins 15 minutes. Si des symptômes apparaissent après le lavage des zones concernées, contacter un médecin.

GEFAHRENHINWEISE

Um der Gefahr eines elektrischen Schlags vorzubeugen:

- Das Gerät wird mit einem geerdeten Stecker und Netzkabel geliefert, das zum Anschluß an die Wechselstromversorgung verwendet werden sollte.
- Das Netzkabel darf nur an eine ordnungsgemäß verkabelte und geerdete Steckdose angeschlossen werden.
- Alle Geräte, an die dieses Produkt angeschlossen ist, müssen ebenfalls an eine ordnungsgemäß verkabelte und geerdete Steckdose angeschlossen sein.
- Die Gehäusedeckel dürfen nicht entfernt werden.
- Das Gerät besitzt keinen Hauptschalter. Um die Stromversorgung zum Monitor zu unterbrechen, müssen Sie den Stecker aus der Steckdose ziehen. Die Steckdose sollte leicht zugänglich sein.

- Das Gerät darf während eines Gewitters nicht ein- oder ausgeschaltet werden.
- Verwenden Sie nur das im Lieferumfang des Monitors enthaltene Netzteil.

Handhabung:

- Seien Sie vorsichtig, wenn Sie das Gerät bewegen.
- Das Bedienfeld darf nicht bedient werden, wenn der Monitor auf der Seite liegt.
- Die in der LCD-Baugruppe verwendete Leuchtstofflampe enthält eine geringe Menge Quecksilber (unter 50 mg). Aus Umweltschutzgründen darf dieses Gerät nicht auf eine Mülldeponie gebracht werden, sondern muß gemäß den örtlichen Vorschriften und Verordnungen entsorgt werden.
- Die LCD-Baugruppe besteht aus Glas, das bei unsanfter Handhabung oder Fallenlassen des Geräts zerbrechen kann. In diesem Fall tritt unter Umständen eine geringe Menge flüssiges Quecksilber aus. Vermeiden Sie den Kontakt mit dieser Substanz, da es sich um einen Reizstoff handelt. Sollten Ihre Augen, Hände usw. damit in Berührung kommen, waschen Sie den betroffenen Bereich mindestens 15 Minuten mit Wasser aus. Wenn nach dem Auswaschen noch Beschwerden festzustellen sind, sollte ein Arzt zu Rate gezogen werden.

GEVAAR

Voor het vermijden van elektrische schokken:

- Dit product wordt geleverd met een voedingskabel voorzien van een geaarde stekker. Voor aansluiting op het lichtnet dient deze voedingskabel gebruikt te worden.
- De voedingskabel dient alleen gebruikt te worden in een stopcontact dat correct bedraad en geaard is.
- Alle apparatuur waar dit product op aangesloten is dient eveneens op een correct bedraad en geaard stopcontact aangesloten te zijn.
- Demonteer niet de dekplaten.
- Dit product is niet voorzien van een netschakelaar. Scheid de monitor van de netspanning door de stekker uit het stopcontact te nemen. Het stopcontact dient goed toegankelijk te zijn.
- Dit product niet tijdens onweer aansluiten of loskoppelen.
- Gebruik altijd de wisselspanningsadapter die bij de monitor meegeleverd is.

Hoe met het product omgegaan moet worden:

- Ga bij verplaatsingen voorzichtig met dit product om.
- Het bedieningspaneel mag niet in horizontale stand bediend worden.

- De fluorescerende lamp in het LCD-samenstel bevat een kleine hoeveelheid kwik (minder dan 50 mg). In verband met milieueisen mag dit product niet als normaal afval gestort worden. Men dient het te verwijderen volgens ter plaatse geldende regels en verordeningen.
- Doordat het LCD-samenstel van glas gemaakt is kan het bij ruwe behandeling of als men het laat vallen, breken. In sommige omstandigheden kan dit tot gevolg hebben dat het vloeibare-kristalmateriaal vrijkomt. Vermijd contact met dit materiaal aangezien het irritaties kan veroorzaken. Als het materiaal in contact komt met ogen, handen, enz., dan moeten deze gedurende minstens 15 minuten met water gespoeld worden; als er na het spoelen nog steeds symptomen aanwezig zijn dient er medische hulp ingeroepen te worden.

PELIGRO

Para evitar el riesgo de descargas eléctricas:

- El producto se suministra con un enchufe con conexión a tierra y con un cable de alimentación para conectar al suministro de corriente alterna.
- Conecte el cable de alimentación sólo a un tomacorrientes con el cableado y conexión a tierra correctos.
- Este producto deberá conectarse a un equipo que esté también conectado a un tomacorrientes con el cableado y conexión a tierra correctos.
- No retire las cubiertas.
- En este producto no se incorpora un interruptor para alimentación de corriente alterna. Para aislar el monitor del suministro de energía eléctrica, desconéctelo del tomacorrientes. Asegúrese de utilizar una toma eléctrica de fácil acceso.
- No conecte o desconecte este producto durante una tormenta eléctrica.
- Utilice siempre el adaptador de corriente alterna que se suministra con el monitor.

Manipulación:

- Al mover el producto, hágalo con cuidado.
- El panel no debe ponerse en funcionamiento si se encuentra en posición horizontal.
- La lámpara fluorescente que se utiliza en la pantalla de cristal líquido (LCD) contiene una pequeña cantidad de mercurio (menos de 50 miligramos). No lo tire junto a basuras que se depositan en vertederos; hacerlo, podría resultar nocivo para el medio ambiente. Tenga en cuenta la normativa local en cuanto a eliminación de desechos.

- La pantalla de cristal líquido (LCD) es de cristal y puede romperse como resultado de un trato brusco o de una caída. Podría suceder que una pequeña cantidad del material de cristal líquido quedase al descubierto. Este material es irritante; evite tocarlo. Asegúrese de evitar el contacto de sus ojos, manos, etc., con el líquido. Si el líquido toca alguna de estas partes, lave el área afectada con agua corriente durante 15 minutos como mínimo y, luego, consulte a un médico.

PERICOLO

Per evitare rischi di scosse elettriche:

- Il prodotto è dotato di una spina e di un cavo di alimentazione con messa a terra che dovranno essere utilizzati per il collegamento all'alimentazione CA.
- Il cavo di alimentazione dovrà essere utilizzato esclusivamente con una presa elettrica adeguatamente cablata e con messa a terra.
- Si dovrà utilizzare una presa adeguatamente cablata e con messa a terra anche per eventuali apparecchiature alle quali il prodotto sia collegato.
- Non smontare le coperture.
- L'apparecchiatura non incorpora un interruttore dell'alimentazione CA. Per isolare il monitor dall'alimentazione elettrica è necessario staccare la spina dalla presa elettrica. La presa elettrica dovrà essere facilmente accessibile.
- Non collegare o scollegare il prodotto durante una tempesta elettrica.
- Utilizzare sempre l'adattatore CA fornito con il monitor.

Note di impiego:

- Maneggiare con cura il prodotto per spostarlo.
- Il monitor non deve essere utilizzato in posizione orizzontale.
- La lampada fluorescente installata nel display a cristalli liquidi (LCD) contiene una piccola quantità di mercurio (meno di 50 milligrammi). Pertanto, per ragioni dettate dalla tutela dell'ambiente, non utilizzare le normali scariche per lo smaltimento del prodotto ma attenersi ai regolamenti e alle ordinanze locali.
- Il display a cristalli liquidi è di vetro e, se lasciato cadere o non maneggiato con cautela, può rompersi. Ciò potrebbe causare in certe condizioni la fuoriuscita di una piccola quantità della sostanza che compone i cristalli liquidi. Evitare il contatto con tale sostanza perché è irritante. Se la sostanza dovesse venire a contatto con occhi, mani, ecc., risciacquare la parte interessata con acqua per almeno 15 minuti. Se, dopo aver risciacquato la parte, si avvertono eventuali sintomi, consultare un medico.

PERIGO

Para evitar o perigo de choques eléctricos:

- O produto é fornecido com uma ficha com massa e um cabo eléctrico que deverá ser utilizado para ligar à alimentação CA.
- O cabo eléctrico deve ser apenas utilizado com uma tomada devidamente electrificada e ligada à massa.
- Qualquer equipamento a que este produto se encontre ligado também tem que estar ligado a uma tomada devidamente electrificada e ligada à massa.
- Não tire as coberturas.
- O produto não possui um interruptor CA. Para isolar o monitor da alimentação eléctrica, tem que tirar a ficha da tomada. A tomada deverá estar num local de acesso fácil.
- Não ligue nem desligue este produto durante uma trovoadas.
- Utilize sempre o adaptador CA fornecido com o monitor.

Manuseamento:

- Manuseie este produto com cuidado quando o deslocar.
- O painel não deverá ser utilizado numa posição horizontal.
- A luz fluorescente utilizada no conjunto do visor de cristais líquidos (LCD) contém uma pequena quantidade de mercúrio (menos de 50 miligramas). Por razões de ordem ambiental este produto não pode ser eliminado num aterro sanitário. Terá que ser eliminado de acordo com as disposições e regulamentos locais.
- O conjunto do visor de cristais líquidos (LCD) é feito de vidro e pode partir-se se for tratado com falta de cuidado ou se cair. Estas situações, em certas circunstâncias, podem levar à exposição de uma pequena quantidade de cristais líquidos. Evite o contacto com este material porque se trata de um produto irritante. Se este material entrar em contacto com os olhos, mãos, etc., a área deverá ser lavada com água durante pelo menos 15 minutos; se, após, a lavagem detectar algum sintoma deverá consultar um médico.

FARE

Sådan undgås risiko for elektrisk stød:

- Dette produkt leveres med et jordstik og en netledning, som skal bruges ved tilslutning til strømnettet.

- Netledningen må kun bruges i en korrekt jordet og tilsluttet stikkontakt.
- Alt udstyr, som dette produkt tilsluttes til, skal også være tilsluttet en korrekt jordforbundet og tilsluttet stikkontakt.
- Dækslerne må ikke fjernes.
- Produktet har ingen strømafbryder. Hvis skærmen skal isoleres fra den elektriske strømkilde, skal stikket tages ud af stikkontakten. Stikkontakten skal være umiddelbart inden for rækkevidde.
- Tilslut og frakobl ikke dette produkt i tordenvej.
- Benyt altid den vekselstrømsadapter, der fulgte med skærmen.

Håndtering:

- Behandl produktet forsigtigt, når det flyttes.
- Panelet må ikke betjenes i vandret stilling.
- Den fluorescerede pære i LCD-skærmen indeholder et mindre kvantum kviksølv (under 50 mg). Af hensyn til miljøet bør dette produkt ikke bortskaffes på en losseplads. Det skal bortskaffes i henhold til lokale love og regulativer.
- LCD-skærmen består af glas, der kan gå itu, hvis den behandles uforsigtigt eller tabes. Dette kan i visse tilfælde medføre udslip af en mindre mængde flydende krystaller. Undgå kontakt med dette materiale, da det kan give anledning til irritation. Hvis dette materiale kommer i kontakt med øjne, hænder osv. bør området skylles med vand i mindst 15 minutter. Kontakt lægen i tilfælde af symptomer efter skyllingen.

ADVARSEL

Slik unngår du risiko for elektrisk støt:

- Produktet er utstyrt med et jordet støpselet og en jordet strømledning som skal brukes til å koble det til strømtilførselen.
- Strømledningen bør bare brukes i en riktig montert og jordet stikkontakt.
- Alt utstyr som dette produktet kobles sammen med, må også kobles til en riktig montert og jordet kontakt.
- Ta ikke av dekselet.
- Produktet har ingen strømbryter. Når du vil bryte strømtilførselen, må du ta ut støpselet fra kontakten. Kontakten bør være lett tilgjengelig.
- Koble ikke til eller fra produktet i tordenvær.
- Bruk alltid vekselstrømsadapteren som følger med skjermen.

Håndtering:

- Vær forsiktig når du flytter produktet.
- Panelet bør ikke brukes i vannrett stilling.
- Lysstoffrøret som er brukt i LCD-enheten, inneholder en liten mengde kvikksølv (mindre enn 50 gram). Av miljøhensyn må dette produktet ikke kastes i naturen, men må behandles som spesialavfall i henhold til lokale lover og regler.
- LCD-enheten består av glass som kan knuses hvis den behandles uforsiktig eller faller i bakken. I noen tilfeller kan dette føre til at litt av LCD-væsken renner ut. Unngå å komme i kontakt med materialet, da det kan forårsake irritasjoner. Hvis materialet kommer i kontakt med øynene, hendene e.l., bør det utsatte området skylles med vann i minst 15 minutter. Oppsøk lege hvis det fortsatt vises symptomer på irritasjon etter vask.

VARNING

Så här undviker du risk för elektriska stötar:

- Produkten är försedd med en jordad stickpropp och sladd för anslutning till eluttag.
- Nätsladden ska bara anslutas till ett korrekt installerat jordat eluttag.
- All utrustning som sammankopplas med denna produkt måste också anslutas till ett korrekt installerat jordat eluttag.
- Ta inte bort kåporna.
- Produkten är inte försedd med nätströmbrytare. Om du vill koppla bort skärmen från elnätet måste du dra ut stickproppen ur eluttaget. Eluttaget ska vara lättåtkomligt.
- Undvika att ansluta eller koppla bort produkten under åskväder.
- Använd alltid nätadaptern som följde med skärmen.

Hantering:

- Hantera produkten varsamt när du flyttar den.
- Panelen får inte användas i horisontellt läge.
- Lampan som används i LCD-enheten innehåller en liten mängd kvicksilver (mindre än 50 milligram). Av miljöskäl får den inte kasseras som vanligt avfall, utan måste kasseras enligt lokala förordningar och regler.
- LCD-enheten är tillverkad av glas och kan gå sönder om den utsätts för ovarsam hantering eller tappas i golvet. Detta kan under vissa omständigheter leda till att en liten mängd av flytande kristall (LCD)-materialet frigörs. Undvik kontakt med detta

material eftersom det kan orsaka irritation. Om materialet skulle komma i kontakt med ögon, händer m m ska området spolras med vatten i minst 15 minuter; uppsök läkare om du har symptom efter spolningen.

VAROITUS

Sähköiskuvaaran välttäminen:

- Tuotteen mukana toimitetaan maadoitettu pistoke ja liitäntäjohto, joita pitäisi käyttää vaihtovirtasyöttöön kytkettäessä.
- Liitäntäjohdon saa kytkeä vain asianmukaisesti johdotettuun ja maadoitettuun pistorasiaan.
- Kaikki laitteet, joihin tämä tuote liitetään, on myös kytkettävä asianmukaisesti johdotettuun ja maadoitettuun pistorasiaan.
- Älä poista suojakansia.
- Laitteessa ei ole vaihtovirtakatkaisijaa. Pistoke on poistettava pistorasiasta monitorin sähkövirran syötön katkaisemiseksi. Pistorasian pitäisi olla helposti käsiksi päästävissä paikassa.
- Älä kytke tuotetta päälle tai päältä ukonilmalla.
- Käytä aina monitorin mukana toimitettua vaihtovirta-adapteria.

Käsittely:

- Käsittele tuotetta varovasti siirtäessäsi sitä.
- Paneelia ei saa käyttää vaakasuorassa asennossa.
- Nestekidenäytössä käytetty loistelamppu sisältää pienen määrän elohopeaa (alle 50 milligrammaa). Ympäristönsuojelusyistä tätä tuotetta ei saa toimittaa kaatopaikalle, vaan se on hävitettävä paikallisten säännösten ja määräysten mukaisesti.
- Nestekidenäyttö on tehty lasista, ja se voi rikkoutua kovakouraisesti käsiteltäessä tai pudotettaessa. Joissakin olosuhteissa tällöin voi päästä vapaaksi pieniä määriä nestekideainetta. Vältä koskettamasta tätä ainetta, sillä se aiheuttaa ärsytystä. Jos aine pääsee kosketuksiin silmien, käsien ym. kanssa, aluetta pitää huuhdella vedellä vähintään 15 minuutin ajan; jos huuhtelun jälkeen havaitaan ärsytysoireita, on käännyttävä lääkärin puoleen.

ΚΙΝΔΥΝΟΣ

Για την αποφυγή κινδύνου ηλεκτροπληξίας:

- Το προϊόν αυτό είναι εφοδιασμένο με ένα γειωμένο φως και ηλεκτρικό καλώδιο τα οποία πρέπει να χρησιμοποιούνται για τη σύνδεση στην παροχή εναλλασσόμενου ρεύματος (AC).
- Το ηλεκτρικό καλώδιο θα πρέπει να συνδέεται μόνο σε πρίζες με κατάλληλη καλωδίωση και γείωση.
- Οι συσκευές στις οποίες θα συνδεθεί αυτό το προϊόν πρέπει επίσης να συνδέονται σε πρίζα με κατάλληλη καλωδίωση και γείωση.
- Μην αφαιρείτε τα καλύμματα.
- Το προϊόν δεν περιλαμβάνει ενσωματωμένο διακόπτη εναλλασσόμενου ρεύματος (AC). Για να απομονώσετε την οθόνη από την παροχή ρεύματος, πρέπει να αφαιρέσετε το φως από την πρίζα. Η πρίζα πρέπει να βρίσκεται σε σημείο εύκολα προσπελάσιμο.
- Μη συνδέετε ή αποσυνδέετε το προϊόν κατά τη διάρκεια ηλεκτροθύελλας.
- Να χρησιμοποιείτε πάντοτε τον προσαρμογέα AC που υπάρχει στη συσκευασία της οθόνης.

Χειρισμός:

- Ο χειρισμός του προϊόντος κατά τη μεταφορά του πρέπει να γίνεται με προσοχή.
- Η οθόνη δεν πρέπει να λειτουργεί σε οριζόντια θέση.
- Ο λαμπτήρας φθορισμού στην οθόνη υγρών κρυστάλλων (LCD) περιέχει μικρή ποσότητα υδραργύρου (λιγότερο από 50 mg). Για λόγους προστασίας περιβάλλοντος, το προϊόν αυτό δεν πρέπει να απορρίπτεται σε χωματερές. Κατά την απόρριψή του πρέπει να ακολουθούνται οι κατά τόπους ισχύουσες σχετικές διατάξεις ή κανονισμοί.
- Η διάταξη της οθόνης υγρών κρυστάλλων αποτελείται από γυαλί και μπορεί να σπάσει σε περίπτωση βίαιου χειρισμού ή πτώσης. Σε μερικές περιπτώσεις, αυτό μπορεί να έχει ως αποτέλεσμα την έκθεση μικρής ποσότητας των υγρών κρυστάλλων. Αποφύγετε την επαφή με το υλικό αυτό γιατί πρόκειται για ερεθιστική ουσία. Εάν το υλικό έρθει σε επαφή με τα μάτια, τα χέρια κλπ, ξεπλύνετε την περιοχή με νερό για τουλάχιστον 15 λεπτά και συμβουλευτείτε ένα γιατρό αν κάποια συμπτώματα επιμένουν μετά το πλύσιμο.

TEHLÝKE

Elektrik arpmasý tehlikesinden kaýnmak iin:

- Cihaz, elektrik bađlantýsý iin topraklanmýþ fipli bir elektrik kablosuyla birlikte gnderilmiþtir.
- Elektrik kablosunun fiþi, elektrik ve toprak bađlantýlarý usulüne uygun olarak yapýlmýþ bir prize takýlmalýdýr.
- Bu cihazýn bađlanacađý diđer t¼m cihazlar da elektrik ve toprak bađlantýlarý usulüne uygun olarak yapýlmýþ prize takýlmýþ olmalýdýr.
- Kapaklarý ýkarmayýnýz.
- Bu cihazda elektriđi ama-kapama d¼đmesi yoktur. Monitr¼n elektrikle bađlantýsýný kesmek iin fiþini prizden ekmeniz gereklidir. Priz, kolayca eriþilebilecek bir yerde olmalýdýr.
- Bu cihazý elektrikselsel fýrtýna sýrasýnda prize takmayýnýz veya prizden ýkarmayýnýz.
- Daima monitr¼n¼zle birlikte gnderilen elektrik adaptr¼n¼ kullanýnýz.

Kaldýrma:

- Bu cihazý taþýrken dikkatli olunuz.
- Panel yatay konumda alýþtýrýlmamalýdýr.
- LCD ekranýn iindeki floresan lamba az miktarda (50 mg'den az) ýva ierir. evre kirlenmesine meydan vermemek iin bu r¼n þehir pl¼đ¼ne atýlmamalýdýr. Yerel ynetmeliklerde belirtilen þekilde yok edilmelidir.
- LCD ekran birimi camdan yapýlmýþtýr ve zenle taþýnmadýđý ya da d¼þ¼r¼ld¼đ¼ takdirde kýrýlabilir. Bu, bazý durumlarda az miktarda sývý kristal maddesinin aýđa ýkmasýna neden olabilir. Bu madde tahrip edici oldu¼ iin ona dokunmayýnýz. Bu madde cildinize, ellerinize vb temas ederse, etkilenen yer 15 dakika akar su altýnda yýkanmalýdýr; yýkadýktan sonra da belirtiler devam ederse týbbi yardým istenmelidir.

Contents

Setup	3
Hardware Requirements	3
Workplace Preparation	3
Lifting the Monitor	3
Working Practices	4
Connecting your Monitor	5
Switching on the Monitor	7
Adjusting the Monitor Position	7
Caring for your Monitor	7
Configuring your Monitor	8
Automatic Setup	8
Before you begin	8
Monitor Information Diskette for Windows 95	9
Auto Setup for the PC	10
Auto Setup for DOS	10
Auto Setup for Windows 3.1, Windows 95, or Windows NT	11
Auto Setup OS/2	12
Auto Setup OS/2	13
Auto Setup for the RS/6000	14
Auto Setup for AIXwindows	15
Auto Setup for the Gt3i, GXT150, or GXT150L Adapter	16
Auto Setup for the GXT150M Adapter	18
Auto Setup for the GT4, GT4X, GT4I, or GT4XI Adapter	20
Auto Setup for the GXT150P (RS/6000 Model 40P) Adapter	22
Auto Setup for the Sun Workstation	24
Auto Setup for the HP Workstation	26

Manual Setup **28**
 Quick Setup 29

User controls **30**
 Front of screen controls 30
 On-screen display (OSD) controls 31

Troubleshooting **35**
 Further Help 36

Specifications **37**

Supported Screen Addressability **38**

Default Preset Timing **39**

Video Adapters **40**
 Adapters for RS/6000 40
 PC Video Adapters 41

Video Cables **42**

Hardware Requirements

This Monitor requires a computer with a suitable on-board sub-system or Video Adapter card that can support SXGA 1280 x 1024 at 75 Hz.

Workplace Preparation

 This section gives advice on what you should consider before you set up your monitor.

Positioning the Monitor

Choose a suitable place to position the monitor where it is not near fluorescent desk lighting. Ensure that the furniture or equipment can support the weight of the monitor. Allow at least 2 inches (50mm) ventilation space around the monitor.

Height

The monitor should be positioned so that the top of the screen is slightly below your eye level when you sit at your workstation.

Orientation

Choose a position that gives the least reflection from lights and windows, usually at a right angle to any windows. The monitor should be positioned directly in front of you so that you do not have to twist your body to use it. Tilt the monitor to a comfortable viewing angle.

Lifting the Monitor

 Do not support the monitor within the screen area. The Liquid Crystal Display is glass and can be damaged by rough handling or excessive pressure.

Hold the bottom of the screen with both hands in the positions shown.

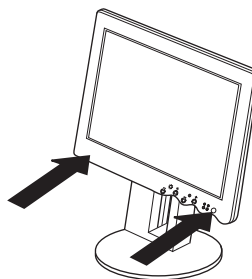

Working Practices



This section gives advice on how you can work comfortably and reduce fatigue.

Rest

Take regular breaks. Vary your posture, stand up and stretch occasionally as prolonged use of computer workstations can be tiring.

Back

You should sit back in your chair and use the backrest.

Hands

Use a light touch on the keyboard, keeping your hands and fingers relaxed. Allow a space in front of the keyboard to rest your wrists when not typing. Consider using a wristpad.

Eyesight

Working with monitors, in common with any prolonged close work, can be visually demanding. Look away from the screen periodically and have your eyesight checked regularly.

Screen settings

Set the screen brightness and contrast to a comfortable level. You may have to adjust this as the lighting changes during the day. Many application programs let you select color combinations which can help you to view in comfort

Connecting your Monitor

 *Be sure to read the 'Safety Information' at the front of this User Guide before carrying out this procedure.*

1. With the monitor standing vertically and at its greatest height, remove the cable cover at the rear of the monitor.

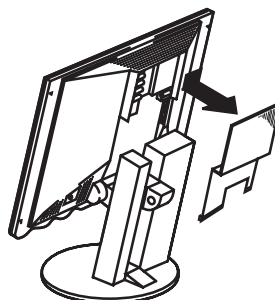

2. Turn off your PC and all attached devices.
3. Plug the video interface cable into the socket marked on your computer.
4. Connect the red, green and blue interface cables into the connectors of the same color on the monitor. Position the ends of the cables in front of the connectors, as shown. Plug the cables into the connectors and push and twist the ends of the cables until they are firmly locked to the connectors.

 *If power-saving function is required, but the system unit does not support power management, then an optional Keyboard/Mouse Y-cable (P/N: 03L7924) can be purchased which allows access to this function within the monitor.*

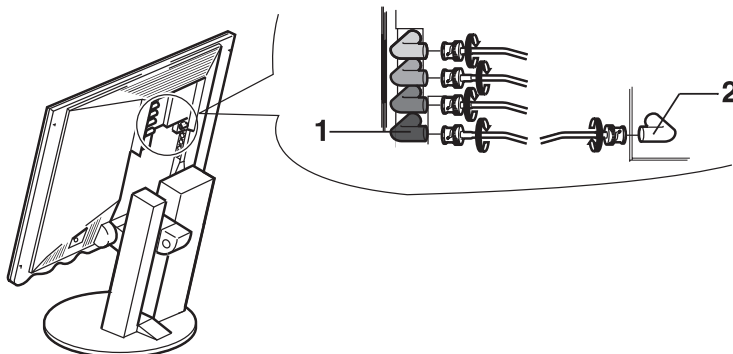

5. If your cable has five connectors, connect the H-Sync (black) interface cable to connection **1**, and connect the V-Sync (white) interface cable to connector **2**.

6. Connect the AC Adapter as shown.

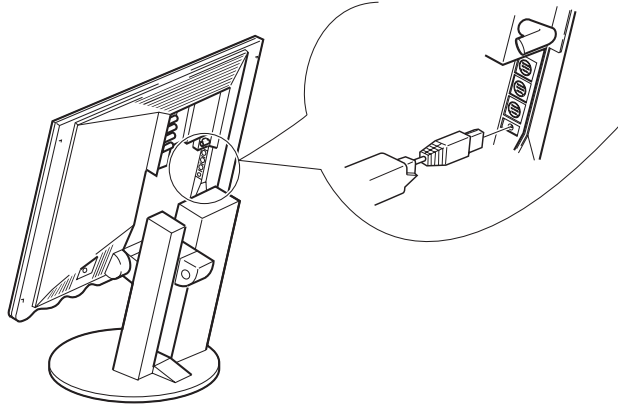

7. Slide the cable cover up to fit it into the monitor while depressing the parts at A , and make sure that they are hooked in to the monitor

 Be careful not to pinch the video signal cable into between the rear cover and the cable cover

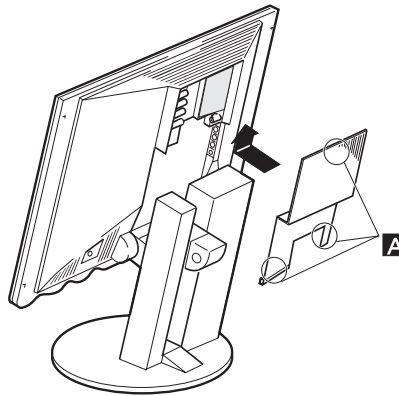

8. Connect the power cord to the AC Adapter.
9. Connect the other end of the power cord to a correctly grounded AC power source.

Switching on the Monitor

Switch on the power source and PC. To turn on the monitor, push and release the power switch. To switch it off, push and release the power switch again.

Adjusting the Monitor Position

Viewing Angle

You can tilt the screen backward or rotate the monitor to the left or right, as shown below.

Height

To adjust the height of the screen, push and hold the adjustment button on the rear of the monitor with one hand, and raise or lower the screen with the other hand.

 Do not insert your finger in the gap at section A. It may get nipped when you lift the monitor screen.

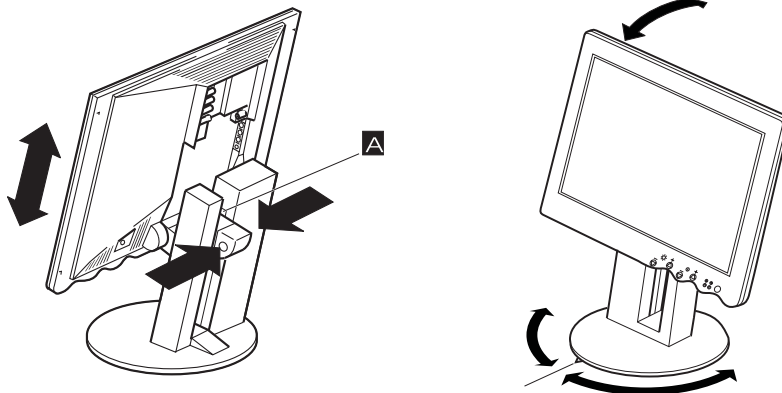

Caring for your Monitor

Be sure to turn off the power before you perform any maintenance on the monitor. Clean your monitor as follows:

- Gently wipe the device covers and the screen with a soft cloth.
- Do not use chemicals such as thinner or benzene. They may damage the surface coating.

Configuring your Monitor

Automatic Setup

 The Setup Utility included on the setup option diskettes are for displaying color-bar patterns. They do not replace or modify the display driver.

 The automatic setup instructions require the monitor to be warmed up for 15 minutes. This is not required for normal operation.

When you first use your monitor you must perform **Automatic (auto) Setup**. This procedure sets up your monitor to process the video signals from your computer without image discoloration or flicker. After you perform auto setup, the settings are stored and used each time you turn on the monitor.

Before you begin

Check the type of computer the monitor is connected to and turn to the appropriate page as shown in the table below.

Type of Computer	Turn to ...
PC	Auto Setup for the PC on page 10
RS/6000	Auto Setup for the RS/6000 on page 14
Sun Workstation	Auto Setup for the Sun Workstation on page 24
HP Workstation	Auto Setup for the HP Workstation on page 26

Monitor Information Diskette for Windows 95

 ***This section must be completed before continuing with the Windows 95 Auto Setup on page 12.***

To utilise the Plug and Play feature in Windows 95, files should be loaded from the IBM Color LCD Monitor Installation diskette as follows :

1. Turn off the computer and all attached devices.
2. Ensure that the IBM monitor that you wish to install is connected correctly.
3. Power on the monitor and then the system unit. Allow the system to boot into Windows 95.
4. Open the DISPLAY PROPERTIES window by clicking on START, SETTINGS, CONTROL PANEL and then double clicking on the DISPLAY icon.
5. Click on the SETTINGS tab.
6. Click the CHANGE DISPLAY TYPE button.
7. Click CHANGE MONITOR TYPE button.
8. Insert the Monitor Information diskette into drive A: and click the HAVE DISK button.
9. Click 'OK'.
10. Choose IBM 9516 monitor and click OK. The files will be copied from the diskette.
11. Close all open windows and remove the diskette.
12. Reboot the system.

 *On LCD monitors, unlike CRTs, a faster refresh rate does not improve display quality. IBM recommends using a refresh rate of 60Hz non-interlaced.*

The system will automatically select the maximum refresh rate and corresponding Colour Matching Profiles.

Auto Setup for the PC

Check the operating system installed on your PC and follow the instructions from the table below.

 **Before carrying out this section it is very important that The Monitor Information Diskette for Windows 95 and Windows 98 has been run. (See page 9).**

Operating System	First follow auto setup on	Then follow auto set-up on
DOS	page 11	
Windows 3.1	page 11	page 12
Windows 95	page 11	page 12
Windows NT	page 11	page 12
Operating System/2 (OS/2)	page 11	page 13

 **If your PC does not run with the setup option diskettes shipped with the monitor, refer to **Quick Setup** on page 29.**

Before you begin the auto setup for your PC :

1. Make a backup copy of the setup option diskettes supplied with the monitor.
2. Make sure the PC's video mode is set in the range of the supported screen resolution shown in the table on page 38.
3. Perform the auto setup for each screen mode you use.

Auto Setup for DOS

 If the monitor is in standby mode (STANDBY ON), it may automatically turn off while you are waiting for it to warm up.

 If you are using PC-DOS/V, change to U.S. mode by typing '**CHEV US**' and pressing ENTER at the command prompt.

 If the screen flickers, repeat the setup several times until the flicker is minimised, or adjust it manually by following **Manual Setup** on page 28.

1. Turn on the monitor first; then the PC.

If the message UNSUPPORTED VIDEO is displayed, or if nothing is displayed check:

- that the video interface cable is connected properly.
 - the correct video adapter card is installed (see **Video Adapters** on page 40).
 - the correct supported display mode is selected for your PC.
2. Wait approximately 15 minutes, until the monitor warms up.
 3. Insert the diskette labelled ' Setup Option Diskette (for DOS / Windows / Windows NT)' into the diskette drive.
 4. Display the command prompt screen of the DOS full-screen display:
 - If Windows is installed, open the DOS prompt from the Program Manager to display the DOS full-screen.
 - If OS/2 is installed, open the DOS full-screen display from the command prompt of OS/2.
 - If only DOS is installed, the command prompt is displayed when the system is started.
 5. At the command prompt, type '**A:**' and press ENTER.
 6. Type '**TESTPATD**' and press ENTER. The color-bar pattern appears.
 7. Wait until the PRESS [ENTER] KEY message is displayed.
 8. Press ENTER to continue the auto setup procedure.
 9. The AUTO SETUP line changes to COMPLETED when auto setup is complete.

If "AUTO SETUP COMPLETED" is not displayed, or the "AUTO SETUP FAILED" message appears, repeat the auto setup procedure several times. If auto setup continues to fail, complete the manual setup on page 28.

10. Type '**Exit**' at the command prompt to return to Windows.

Now continue the setup for your operating system:

Auto Setup for Windows 3.1, Windows 95, or Windows NT on page 12

Auto Setup OS/2 on page 13

Auto Setup for Windows 3.1, Windows 95, or Windows NT

Continued from **Auto Setup for DOS** on page 11

 If the monitor is in standby mode (STANDBY ON), it may automatically turn off while you are waiting for it to warm up.

11. Drag the icon bar and tool bar, if they are displayed, to the bottom of the screen
12. Insert the diskette labelled ' Setup Option Diskette (for DOS / Windows / Windows NT)' into the diskette drive.
13. Check the operating system installed on your PC and follow the instructions from the table below

Operating system	Step 1	Step 2	Step 3	Step 4
Windows 3.1	open Program Manager	click on File	click on run	Type 'A:\TESTPAT'
Windows NT 3.5	open Program Manager	click on File	click on run	
Windows 95	click on Start	click on Run		
Windows NT 4.0	click on Start	click on Run		

 The size and diversity of the color pattern varies with the screen resolution.

 If the screen flickers, repeat the setup several times until the flicker is minimised, or adjust it manually by following **Manual Setup** on page 28.

14. The color-bar pattern appears and auto setup starts.
 15. Position the mouse pointer at the bottom center of the screen. This allows auto setup to run properly.
 16. The AUTO SETUP line changes to COMPLETED when auto setup is completed.
If "AUTO SETUP COMPLETED" is not displayed, or the "AUTO SETUP FAILED" message appears, repeat the auto setup procedure several times. If auto setup continues to fail, complete the **Manual Setup** on page 28.
 17. Press ALT+F4 to exit auto setup.
- You have completed the monitor setup.

Auto Setup OS/2

 If the monitor is in standby mode (STANDBY ON), it may automatically turn off while you are waiting for it to warm up.

 The size and diversity of the color pattern varies with the screen resolution.

 If the screen flickers, repeat the setup several times until the flicker is minimised, or adjust it manually by following **Manual Setup** on page 28.

Continued from **Auto Setup for DOS** on page 11

11. If the WarpCenter Toolbar is permanently on, click the right mouse button on the WarpCenter Toolbar, click on Properties, Display Tab and 'Show only when mouse in center position'.
12. Insert the diskette labelled ' Setup Option Diskette (for OS/2)' into the diskette drive.
13. Open the OS/2 full-screen window or an OS/2 window.
14. At the command prompt type A: and press ENTER.
15. Type TESTPATS and press ENTER.
16. After approximately 1 minute, the color-bar pattern appears.
17. Move the mouse pointer (and the icon bar and tool bar if they are displayed) to the bottom center of the screen to allow setup to run properly.
18. The AUTO SETUP line changes to COMPLETED when auto setup is completed after 10 to 20 seconds.

If "AUTO SETUP COMPLETED" is not displayed, or the "AUTO SETUP FAILED" message appears, repeat the auto setup procedure several times. If auto setup continues to fail, complete the **Manual Setup** on page 28.
19. Press ALT+F4 to exit auto setup.

You have completed the monitor setup.

Auto Setup for the RS/6000

If you are running AIXwindows on the RS/6000, go to **Auto Setup for AIXwindows** on page 15. Otherwise, check the following table for the type of Video Adapter used with the RS/6000:

 If you are using a Video Adapter other than those in the table, the setup option diskettes will not run on your RS/6000 (See **Quick Setup** on page 29).

 If the screen resolution in the video signal on your RS/6000 is not 1280x1024, the setup option diskettes will not run on your RS/6000 (See **Quick Setup** on page 29).

Video Adapter Type	Section
GXT150P (RS/6000 Model 43P)	Auto Setup for AIXwindows on page 15
GXT 1000	Auto Setup for AIXwindows on page 15
E15/S15	Auto Setup for AIXwindows on page 15
Gt3i GXT150 GXT150L	Auto Setup for the Gt3i, GXT150, or GXT150L Adapter on page 16
GXT150M (for AIX 3.2 Version 3.2.5.1 and later)	Auto Setup for the GXT150M Adapter on page 18
GT4 (24 bit) GT4X (8 bit) GT4X (24 bit) GT4I (24 bit) GT4XI (8 bit) GT4XI (24 bit)	Auto Setup for the GT4, GT4X, GT4I, or GT4XI Adapter on page 20
GXT150P (RS/6000 Model 40P)	Auto Setup for the GXT150P (RS/6000 Model 40P) Adapter on page 22



Auto Setup for AIXwindows

 If the monitor is in standby mode (STANDBY ON), it might automatically turn off while you are waiting for it to warm up.

1. Turn on the monitor, then the RS/6000. The screen remains blue until the system is ready.

If the message UNSUPPORTED VIDEO is displayed, or if nothing is displayed check:

- that the video interface cable is connected properly.
- the correct video adapter card is installed (see page 40).
- the correct supported display mode is selected for your PC.

2. When the AIX desktop login screen is displayed, login as the root user, and start the common desktop environment (CDE) from the AIX command prompt. Type XINIT and press ENTER.
3. Wait for about 15 minutes, until the monitor warms up.
4. Start the terminal emulator. To start, click on the SUBPANEL BUTTON  on the text editor control  on the front panel, and then select TERMINAL EMULATOR.
5. Type '**cd /**' from the command prompt of the terminal emulator, and press ENTER.
6. Type '**df -k**' and press ENTER. Make sure that there is at least 60 KB of free space in the root directory.
7. Insert the diskette labelled "Setup Option Diskette (for AIXwindows)" into the diskette drive. Type '**tar -xvf /dev/fd0**' and press ENTER.
8. Type '**./xcolorbar**' and press ENTER.
If 'CAN'T ALLOCATE COLOR' is displayed :
 - Stop other programs.
 - Enter the commands in step 7 again.
 - Type ./xcolorbar and press Enter.
 - If, after a few seconds, the setup main menu appears and starts automatically, go to step 12. If it does not appear and start automatically, go to the next step.
9. The Auto Setup starts.
10. The messages are automatically displayed in the following sequence: 'OFF-READY- START-COMPLETED' and auto setup is complete.

If "AUTO SETUP COMPLETED" is not displayed, or the "AUTO SETUP FAILED" message appears, repeat the auto setup procedure several times. If auto setup continues to fail, complete the **Manual Setup** on page 28.

You have completed the monitor setup.

 If the screen flickers, repeat the setup several times until the flicker is minimised, or adjust it manually by following **Manual Setup** on page 28.

Auto Setup for the Gt3i, GXT150, or GXT150L Adapter

 If the monitor is in standby mode (STANDBY ON), it may automatically turn off while you are waiting for it to warm up.

1. Turn on the monitor, then the RS/6000. The screen remains blue until the system is ready.

If the message UNSUPPORTED VIDEO is displayed, or if nothing is displayed check:

- that the video interface cable is connected properly.
 - the correct video adapter card is installed (see page 40).
 - the correct supported display mode is selected for your PC.
2. When the AIX desktop login screen is displayed, login as the root user, and start the common desktop environment (CDE) from the AIX command prompt. Type **'diag'** and press ENTER.
 3. Wait for about 15 minutes, until the monitor warms up.
 4. Press ENTER to display the Function Selection menu. Move the cursor to SERVICE AID.
 5. Press Enter. The Service Aids Selection menu appears.
 6. Press PAGEDOWN to display the second page of the menu. Move the cursor to DISPLAY TEST PATTERNS.
 7. Press ENTER and move the cursor and select the connected VIDEO ADAPTER.
 8. Press ENTER and move the cursor to THE COLOR-BAR PATTERN.
 9. Press ENTER and ENTER again to display the color-bar pattern.
If 'CAN'T ALLOCATE COLOR' is displayed :
 - Stop other programs.
 - Enter the commands in step 7 again.
 - Type ./xcolorbar and press Enter.
 - If, after a few seconds, the setup main menu appears and starts automatically, go to step 12. If it does not appear and start automatically, go to the next step.

10. Press the Setup Switch on the back of the monitor and the setup main menu appears in front of the color-bar.

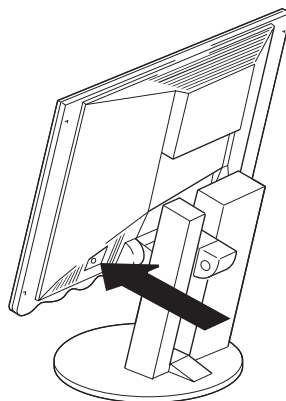

*If the screen flickers, repeat the setup several times until the flicker is minimised, or adjust it manually by following **Manual Setup** on page 28.*

11. Push one of the contrast  control buttons. The messages are automatically displayed in the following sequence : 'OFF-READY-START-COMPLETED' and auto setup is complete.

If "AUTO SETUP COMPLETED" is not displayed, or the "AUTO SETUP FAILED" message appears, repeat the auto setup procedure several times. If auto setup continues to fail, complete the **Manual Setup** on page 28.

12. Press F3 to exit the color-bar pattern.
13. Press the Setup Switch on the back of the monitor to turn off the setup main menu.

You have completed the monitor setup.

Auto Setup for the GXT150M Adapter

 If you are using more than one GXT150M Video Adapter - select the display with the following AIX commands, and then perform steps 5 to end. The *x* indicates the number of the adapter that displays the test pattern - **chdisp -tx** and **dhdisp -dx**.

 If the monitor is in standby mode (STANDBY ON), it might automatically turn off while you are waiting for it to warm up.

For AIX 3.2 Version 3.2.5.1 and Later

1. Turn on the monitor, then the RS/6000. The screen remains blue until the system is ready.

If the message UNSUPPORTED VIDEO is displayed, or if nothing is displayed check:
 - that the video interface cable is connected properly.
 - the correct video adapter card is installed (see page 40)
 - the correct supported display mode is selected for your PC.
2. When the AIX desktop login screen is displayed, log in as the root user, type '**!slpp -h > /tmp/ptfcheck**' from the AIX command prompt, and press ENTER.
3. Open the '**/tmp/ptfcheck**' file with an editor or other tool. In the '**/tmp/ptfcheck**' file, decide whether to apply the newest GXT150M PTF, based on the following conditions :
 - If the file does not include lines a, b, or c (not counting XX) : Do not apply the PTF.
 - If the file does include lines a, b, or c (not counting XX), but there is also an added line : Do not apply the PTF.
 - If the file includes lines a, b, or c (not counting XX), and if there is no added line : Apply the PTF.
4. Type '**rm -f /tmp/ptfcheck**' and press ENTER.
5. Type '**cd /**' and press ENTER.
6. Type '**df**' and press ENTER. Make sure that there is at least 60 KB of free space in the root directory.
7. Insert the diskette labelled "Setup Option Diskette (for GXT150M)" into the diskette drive. Type '**tar -xvf /dev/rfd0**' and press ENTER.
8. Type '**./colorbar**' and press ENTER.
9. Press ENTER. The color-bar pattern is displayed on the screen. Make sure that the monitor warms up (or more than 15 minutes have passed since you turned on the monitor).

10. Press the Setup Switch on the back of the monitor and the setup main menu appears in front of the color-bar pattern.

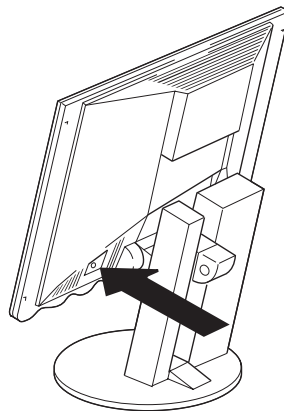



11. Push one of the contrast  control buttons.
12. The messages are automatically displayed in the following sequence : 'OFF-READY- START-COMPLETED' and auto setup is complete.
If "AUTO SETUP COMPLETED" is not displayed, or the "AUTO SETUP FAILED" message appears, repeat the auto setup procedure several times. If auto setup continues to fail, complete the **Manual Setup** on page 28.
13. Press F3 to exit the color-bar pattern.
14. Press the Setup Switch on the back of the monitor to turn off the setup main menu.

 If the screen flickers, repeat the setup several times until the flicker is minimised, or adjust it manually by following **Manual Setup** on page 28.

You have completed the monitor setup.

Auto Setup for the GT4, GT4X, GT4I, or GT4XI Adapter

 If you cannot see the login prompt, adjust the brightness and contrast.

 If the monitor is in standby mode (STANDBY ON), it may automatically turn off while you are waiting for it to warm up.



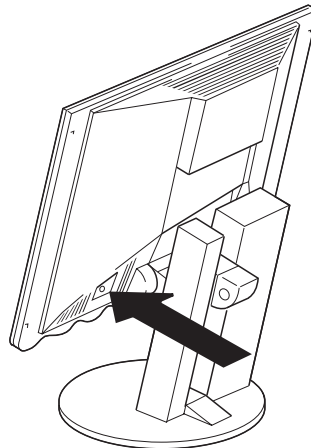

1. Turn on the monitor, then the RS/6000. The screen remains blue until the system is ready.

If the message UNSUPPORTED VIDEO is displayed, or if nothing is displayed check:

- that the video interface cable is connected properly.
 - the correct video adapter card is installed (see page 40).
 - the correct supported display mode is selected for your PC.
2. When the AIX desktop login screen is displayed, login as the root user, type **'diag'** from the AIX command prompt, and press ENTER.
 3. Wait for about 15 minutes, until the monitor warms up.
 4. Press ENTER to display the Function Selection menu. Move the cursor to SERVICE AID.
 5. Press ENTER. The Service Aids Selection menu appears.
 6. Press PAGEDOWN to display the second page of the menu. Move the cursor to DISPLAY TEST PATTERNS.
 7. Press ENTER and move the cursor and select the connected VIDEO ADAPTER.
 8. Press ENTER and move the cursor to THE COLOR-BAR PATTERN.
 9. Press ENTER and ENTER again to display the color-bar pattern.
 10. Press the Setup Switch on the back of the monitor and the setup main menu appears in front of the color-bar pattern.



 If the screen flickers, repeat the setup several times until the flicker is minimised, or adjust it manually by following **Manual Setup** on page 28.

11. Press one of the contrast  control buttons. The messages are automatically displayed in the following sequence :
 'OFF-READY- START-COMPLETED' and auto setup is complete.
 If "AUTO SETUP COMPLETED" is not displayed, repeat the auto setup procedure several times. If auto setup continues to fail, complete the **Manual Setup** on page 28.
12. Press **F3** to exit the color-bar pattern.
13. Type CLEAR at the AIX command prompt and press ENTER to perform setup on black level.
14. Push one of the brightness  control buttons and select the item BLACK SETUP.
15. Push one of the contrast  control buttons. After about 10 seconds, the message 'SAVE PARAMETERS?' is displayed.
 If 'BLACK SETUP FAILED' is displayed - if the message 'SAVE PARAMETERS?' is not displayed or BLACK SETUP does not start, do the following :
 - Confirm that the screen is completely black except for the command prompt. If not, type '**clear**' and press ENTER.
 - Go back to step 15 and redo black setup.
 If black setup is not completed after several tries, adjust OFFSET R, OFFSET G, OFFSET B (see **Specialist Controls** on page 33).
16. To save the settings for the monitor, push a contrast control  button. To discard the settings, push one of the brightness  control button.
17. Press the Setup Switch on the back of the monitor to turn off the setup main menu.

You have completed the monitor setup.

Auto Setup for the GXT150P (RS/6000 Model 40P) Adapter

 If the monitor is in standby mode (STANDBY ON), it may automatically turn off while you are waiting for it to warm up.

1. Insert the 'IBM RISC System/6000 Model 40P, System Management Service Diskette' into drive A of the RS/6000 Model 40P Adapter. Turn on the power.

If the message UNSUPPORTED VIDEO is displayed, or if nothing is displayed check:

- that the video interface cable is connected properly.
- the correct video adapter card is installed (see page 40)
- the correct supported display mode is selected for your PC.

2. When the Power Personal System panel is displayed, press **F4**. The screen remains blue until the system is ready.
3. From the main menu of System Management Service, select 'Test The Computer'. Then press ENTER.
4. Wait for about 15 minutes, until the monitor warms up.
5. In the Select Device Test menu, push the spacebar to erase the mark displayed with 'Test All Subsystems'. Use the ↓ key to place the cursor on GTP150P. Push the spacebar to select GXT150P. Then press **F6**.
6. Use the ↓ key to select 'Run Monitor Service Aids' in the IBM GXT150P Video Adapter menu. Press ENTER.
7. When GXT150P Information is displayed, press ENTER.
8. When the color-bar pattern is displayed, push the setup switch on the back of the monitor. The setup main menu appears on top of the color-bar pattern.

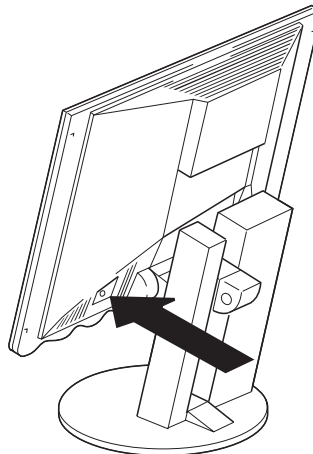



 If the screen flickers, repeat the setup several times until the flicker is minimised, or adjust it manually by following **Manual Setup** on page 28.

9. Press one of the contrast  control buttons. The messages are automatically displayed in the following sequence : 'OFF-READY-START-COMPLETED' and auto setup is complete.
 10. Press the setup switch on the back of the monitor to turn off the setup main menu.
If "AUTO SETUP COMPLETED" is not displayed, or the "AUTO SETUP FAILED" message appears, repeat the auto setup procedure several times. If auto setup continues to fail, complete the **Manual Setup** on page 28.
 11. Press ENTER to exit the color-bar pattern. GXT150P Information is displayed again.
 12. Press ENTER. The entire screen is displayed in red. Press ENTER.
 13. Press ENTER six times. Make sure the entire screen is displayed in the following sequence:
Green → blue → white → black → 8× 6 grid pattern → 8× 10 grid pattern.
 14. When **GXT150P Information** is displayed, press ENTER.
 15. When the IBM GXT150P Video Adapter menu is displayed, press ESC.
 16. When the **Test Completed** message is displayed, press ENTER.
 17. When **Select Device to Test** is displayed, press ESC to exit.
 18. When the **System Management Service** panel is displayed, press F3.
 19. Select **Reboot**.
 20. Remove the diskette from drive A.
 21. When "Do you want to restart the computer?" is displayed, select YES and press ENTER.
- You have completed the monitor setup.

Auto Setup for the Sun Workstation

 The screen resolution 1280 × 1024 is available in some Sun video cards. When you use such a card, change the standard screen resolution from 1152×900 to 1280×1024 on the workstation.

 If the monitor is in standby mode (STANDBY ON), it might automatically turn off while you are waiting for it to warm up.

 It may be necessary to attach a CRT monitor until the video adapter has been set up to a supported video mode.

If you use OpenWindows with the screen resolution 1280×1024, perform auto setup as follows. Otherwise, perform **Quick Setup** on page 29

1. Set the screen resolution to 1280×1024. Refer to your Sun workstation manuals, Open Windows manuals, or online help to set the mode.
2. Turn on the monitor. Turn on the Sun workstation.

If the message UNSUPPORTED VIDEO is displayed, or if nothing is displayed

- check that the video interface cable is connected properly.
- The screen resolution and the vertical frequency of Sun workstation are within the supported screen resolutions in the table on page Supported Screen Addressability. If not, refer to your Sun workstation manuals, Windows manuals, or online help to set the resolution and frequency to the values of the table.

3. Log in as the root user. If you start the system from the command prompt, start the Open Windows after login.
4. Wait for about 15 minutes, until the monitor warms up.
5. If the terminal emulator in the command prompt window has not started yet, start the emulator.
6. Type '**cd /**' from the command prompt of the terminal emulator, and press ENTER.
7. Insert the diskette labelled 'Setup Option Diskette (for Solaris)' into the Sun workstation's diskette drive A.
8. Type '**tar -xvf /dev/fd0**' and press ENTER.
9. Type '**./xcolorbar**' and press ENTER.

If 'CAN'T ALLOCATE COLOR' is displayed :

- Stop other programs.
- Enter the commands in step 7 again.
- Type **./xcolorbar** and press Enter.

10. When the color-bar pattern appears, push the setup switch on the back of the monitor. The setup main menu appears on top of the color-bar pattern.

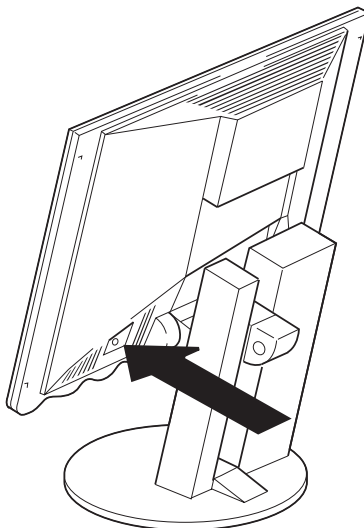



*If the screen flickers, repeat the setup several times until the flicker is minimised, or adjust it manually by following **Manual Setup** on page 28.*

11. Push one of the contrast  control buttons.
12. The messages are automatically displayed in the following sequence : OFF-READY-START-COMPLETED' and auto setup is complete. The screen might be distorted during setup. This is not a problem.
If "AUTO SETUP COMPLETED" is not displayed, or the "AUTO SETUP FAILED" message appears, repeat the auto setup procedure several times. If auto setup continues to fail, complete the **Manual Setup** on page 28.
13. The color-bar pattern appears. The colors must be bright and clear.
14. There is no interference in the upper low frequency section, and the boundary between black and white is clear.
15. Press any key to exit the color-bar pattern.
16. Push the setup switch on the back of the monitor to turn off the setup main menu.

You have completed the monitor setup.

Auto Setup for the HP Workstation

 The device names '**fd0**' may vary by workstation model. You can list the device names by typing '**ls /dev/floppy**' and pressing RETURN.

 The standard commands of **uncompress** and **xwud** are needed to run this shell script.

1. Turn on the power of the monitor, then the workstation.

If the message UNSUPPORTED VIDEO is displayed, or if nothing is displayed

- check that the video interface cable is connected properly.
- The screen resolution and the vertical frequency of the HP Sun workstation are within the supported screen resolutions in the table page 38 Supported Screen Addressability. If not, refer to your HP workstation manuals, Windows manuals, or online help to set the resolution and frequency to the values of the table.

2. Login as a root user.
3. Wait about 15 minutes until the workstation reaches the normal operating temperature.
4. If the terminal emulator (command prompt window) has not yet started, start it now.
5. Type '**cd **' at the terminal emulator command prompt and then press RETURN.
6. Insert the diskette labelled 'Setup Option Diskette (For HP)' into the diskette drive. Type '**tar -xvf /dev/fd**' and press RETURN.
7. Type '**./xcolorbar**' and press RETURN. The color-bar pattern appears.
8. Press the setup switch on the back of the monitor. The setup main menu appears in front of the color-bar pattern.

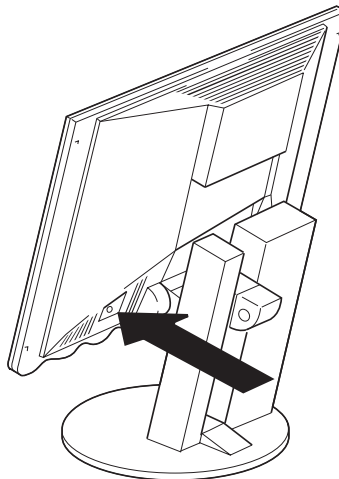

 If the screen flickers, repeat the setup several times until the flicker is minimised, or adjust it manually by following **Manual Setup** on page 28.

9. Select AUTO SETUP and press the contrast button . "OFF" automatically changes to "READY" and then to "COMPLETED," and setup ends automatically. The screen might be distorted during setup. This is not a problem.

If "AUTO SETUP COMPLETED" is not displayed, or the "AUTO SETUP FAILED" message appears, repeat the auto setup procedure several times. If auto setup continues to fail, complete the **Manual Setup** on page 28.

10. Press the setup switch on the back of the monitor to exit the setup main menu.

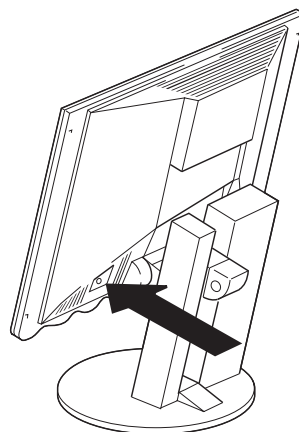

11. Press 'q' to end the color pattern.
12. Push the setup switch on the back of the monitor to turn off the setup main menu.
13. Enter the following if you no longer need the files in the hard disk :
 - rm xbar.xwd
 - rm xcolorbar

You have completed the monitor setup.





Manual Setup

 If the monitor is in standby mode (STANDBY ON), it might automatically turn off while you are waiting for it to warm up.

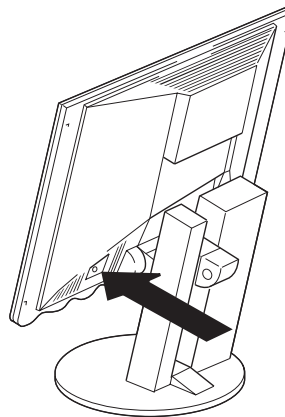
Normally, you can complete the setup procedure using auto setup. However, if your screen image is still distorted after you perform auto setup, perform manual setup.

1. Wait for about 15 minutes, until the monitor warms up.
2. Display the image you most frequently use on the screen.
3. Push the setup switch on the back of the monitor.





4. Push one of the brightness  control buttons and select the item CLOCK in **Intermediate Controls** on page 32. Then push one of the contrast  control buttons to minimise the number of vertical lines on the screen.
5. Push one of the brightness  control buttons, and select the item H-POSI to adjust the horizontal display position. Likewise, select the item V-POSI to adjust the vertical display position.
6. Push one of the brightness  control buttons and select the item PHASE, and adjust the contrast to reduce the distortion on the screen.
7. Select SAVE. Then push one of the contrast  control buttons to save the settings. The color of the characters “SAVE” changes from red to yellow, and back to red again.
8. Push the setup switch on the back of the monitor to exit the menu.

Quick Setup

 Check that the screen resolution and the frequencies are within the **Supported Screen Addressability** on page 38. If not, change the settings on the computer to set them within the range.

 You need a full screen image to perform proper auto setup. You also need a clear contrast between the brightest part of the screen and the darkest for correct adjustment. Otherwise, the screen may flicker.

 If the "Save Parameters?" message is not displayed or the auto setup value "START" does not change, push the contrast control button to exit auto setup and go back to step 4. Display another full-screen image and redo auto setup. If auto setup is not completed after several tries, perform **Manual Setup** on page 28.



 If you are using a workstation, the screen appears greenish because the black level is shifted due to the difference of the voltage level of the video signals. If this happens, adjust **OFFSET G** in the **Specialist Controls** on page 33.

This procedure does not display a color-bar pattern before the setup main menu. To obtain better image quality, you should perform auto setup according to the procedures on the preceding pages with the setup option diskettes for PC-DOS, Window 3.1, Windows 95, Windows NT, OS/2, RS/6000, AIXWindows, or OpenWindows on Sun Workstation (if the diskettes do not run, perform this quick setup).

For the HP Workstation, if you are unable to perform auto-setup with the diskettes, perform the quick setup without them.

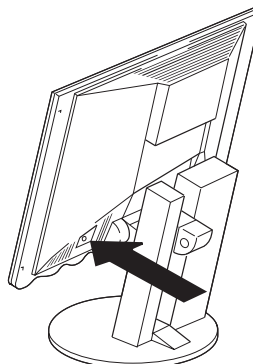
1. Turn on the monitor and the System Unit and wait for about 15 minutes until the machine warms up.
2. Start the operating system on the System Unit and display a full-screen image.
3. Push the setup switch on the back of the monitor. The setup main menu appears.







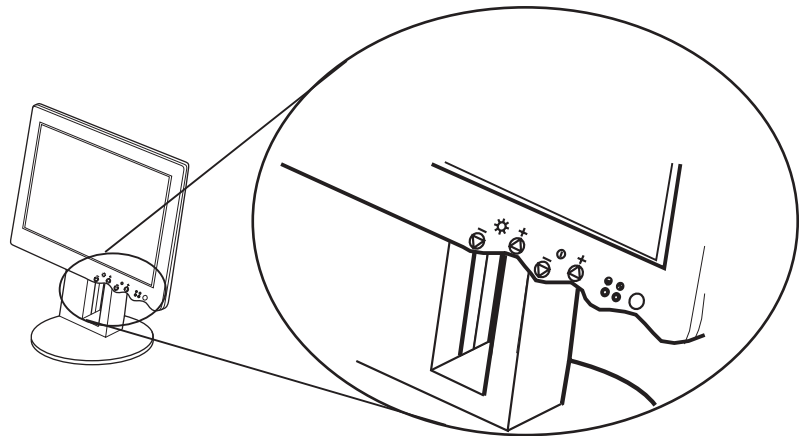

4. Push one of the brightness control  buttons to select AUTO SETUP.
5. Push one of the contrast control  buttons. After about 10 seconds, the message "Save parameters?" is displayed.
6. To save the settings for the monitor, push a contrast control  button. To discard the settings (because some problem such as a screen flicker occurs), push a brightness control button.
7. If, after you save the settings, the display is still distorted, adjust "PHASE" and "CLOCK" in **Manual Setup** on page 28.
8. Push the setup switch on the back of the monitor to turn off the setup main menu.

User controls

Front of screen controls

The front of screen user controls allow the user to turn the monitor on and off, adjust the brightness and contrast of the monitor to meet the users preferences, and also to gain access to intermediate and advanced On-Screen Display Controls.



Icon	Control	Description
	Power Switch	Switches the monitor on and off
	Power Indicator	Green Light
	Standby indicator	Green Light
	Contrast Control	Adjust contrast between foreground and background
	Brightness Control	Adjusts background brightness

On-screen display (OSD) controls

To display the OSD, press the setup switch on the back of the monitor as shown.

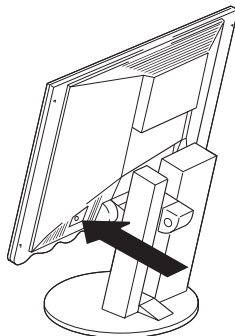



Menu	+	-
Brightness		
Contrast		

There are eight menus within the OSD. These menus contain the following functions which can be divided into four levels of adjustment : basic, intermediate, advanced and specialised. The final menu "Information" gives the user information regarding their monitor.



Basic Controls

Function	Location	Effect of control	Description
AUTO SETUP	Menu 1 of 8	OFF / ON	'AUTO SETUP - OFF' is displayed. Start auto setup. 'START'-'COMPLETED' are displayed in sequence until auto setup is complete.
STANDBY	Menu 2 of 8	OFF, 5 to 60 MINS, DPMS	Set the number of minutes the monitor is out of use before automatically entering the power-saving mode. Specify OFF if you do not use this function.

Intermediate Controls

Function	Location	Effect of control	Description
CLOCK	Menu 3 of 8	+.....MHz.....-	Adjust this parameter to suppress the display of vertical stripes.
PHASE	Menu 3 of 8	0.....23	When there are visual noises on the edges of characters and graphics, adjust this parameter to suppress the noise.
H-POSI	Menu 6 of 8		Moves image left or right.
V-POSI	Menu 6 of 8		Moves image up or down.
SYSTEM RESET	Menu 7 of 8	YES / NO	Use this parameter to restore all the values to the original settings when the monitor was shipped.

Advanced Controls

Function	Location	Effect of control	Description
H-SIZE	Menu 6 of 8		Adjusts image width.
V-SIZE	Menu 6 of 8		Adjusts image height.
EXPANSION	Menu 3 of 8	ON / OFF / USER	To display a screen with resolution less than 1280×1024 (the optimum resolution of the monitor), select the optimum size you want by specifying one of the following : ON: Displays a full screen. This is the normal selection. OFF: Displays the screen specified by your PC. USER: Enables you to set the screen size by specifying H-size and V-size. This setting can be set and saved for each screen resolution.
SHARP	Menu 3 of 8	0.....255	Adjust to eliminate some of the high frequency noise in the video signal.
AUTO DETECT	Menu 1 of 8	OFF / ON	For DOS, Windows, OS/2, or AIX windows, to enable auto setup to start automatically, specify ON. This is the normal setting.

Specialist Controls

Function	Location	Effect of control	Description
RED	Menu 4 of 8	0.....255	Adjusts the red hue level of the screen.
GREEN	Menu 4 of 8	0.....255	Adjusts the green hue level of the screen.
BLUE	Menu 4 of 8	0.....255	Adjusts the blue hue level of the screen.
OFFSET R	Menu 5 of 8	0.....255	When there is red noise on the black part of the screen, adjust this parameter to suppress it.
OFFSET G	Menu 5 of 8	0.....255	When there is green noise on the black part of the screen, adjust this parameter to suppress it.
OFFSET B	Menu 5 of 8	0.....255	When there is blue noise on the black part of the screen, adjust this parameter to suppress it.
BLACK SETUP	Menu 1 of 8	ON/OFF	To adjust the black level of the screen during auto setup if the monitor is used with the RS/6000 and GT4 Adapter, select this item. This only works with the screen resolution 1280×1024.

Information

Function	Location	Description
H-FREQUENCY	Menu 8 of 8	The frequency of the video signal (horizontal sync signal) from your PC (KHz).
V-FREQUENCY	Menu 8 of 8	The frequency of the video signal (vertical sync signal, or refresh rate) from your PC (Hz).
SYNC POLARITY	Menu 8 of 8	The polarity of the video signal from your PC. H stands for the horizontal sync signal, and V stands for the vertical sync signal.
SYNC TYPE	Menu 8 of 8	The type of the video signal from your PC.
RESOLUTION	Menu 8 of 8	The resolution of the video signal from your PC.
SOFTWARE VERSION	Menu 8 of 8	The version number of the control program installed in the monitor.

Troubleshooting

If you suspect something is not working correctly, you should :

 The LCD contains over 3,900,000 thin-film transistors (TFTs). A small number of missing, discolored, or lighted dots may be present on the screen, which is an intrinsic characteristic of the TFT LCD technology and is not an LCD defect.

1. Turn on the computer and monitor.
2. Set the brightness  control to the proper position.
3. Ensure that all cables are securely connected.
4. Disable standby mode if it is enabled. Push the setup switch on the back of the monitor to determine whether standby mode is enabled.
5. Disable the computer's screen saver program if it is enabled.
6. Run the auto setup procedure described in **Configuring your Monitor** on page 8
7. If there is screen noise, adjust the PHASE parameter in the **Intermediate Controls** on page 32.
8. Adjust the CLOCK parameter in the **Intermediate Controls** on page 32 to suppress the display of vertical stripes.
9. If you are using an RS/6000 with composite output function, do not specify 'DPMS' to the STANDBY parameter in the **Basic Controls** on page 31.
10. To restore all the auto setup settings to the original values in effect when the monitor was shipped, perform SYSTEM RESET in the **Intermediate Controls** on page 32, or press each minus button of the brightness and the contrast control simultaneously and turn on the monitor. Both LED indicators turn on and off, and all settings are restored.
11. Set the screen mode to the **Supported Screen Addressability** in the table on page 38.
12. Perform AUTO SETUP for each display mode (each screen resolution).
13. On this monitor, different from a CRT, faster refresh rate does not make the screen quality better. Using the monitor with a refresh rate of 60 Hz with noninterlace is recommended.

Further Help

If you are unable to correct the problem yourself, you may seek further help as follows:

Call the IBM HELPCENTER.

In the US call 1-800-772-2227

In Canada call 1-800-565-3344

In other countries contact your dealer, retailer, or other IBM authorized Servicer.

Before calling, please have available as much of the following information as possible:

1. Model and serial number from the label on the front of your monitor.
2. Purchase receipt.
3. Description of problem.
4. Computer type and model.
5. System configuration (hardware fitted, etc.).
6. System BIOS version number.
7. Operating System and version number.
8. Display driver version number.

 *If possible, stay by your computer. Your Technical Support Representative may wish to go through the problem with you during the call.*

Specifications

RGB input connector	BNC jack
Video input impedance (RGB)	75 ohms
Video amplification	0.7V _{p-p} , 1.0V _{p-p} (composite)
Input voltage (AC Adapter)	100 to 127 V rms 50/60 Hz 200 to 240 V rms 50/60 Hz
Power dissipation (max)	55 W
Power dissipation (in power-off mode)	8 W

 Some types of composite sync signals are not supported.

Sync Signal Type

The following Sync signal types are supported :

- Separate sync (TTL level).
- Sync on green *.
- Composite sync (TTL level).

* Horizontal sync pulses must not be suppressed during the vertical sync period.

Supported Screen Addressability

The following table shows the supported screen resolutions :

 The input signal to this monitor should correspond with the screen resolutions, Hsync frequencies and Vsync frequencies shown in the table.

Type	Screen Resolution (H × V)	Hsync (KHz)	Vsync (Hz)
VGA	640 × 350 (NI)	30 – 40	69 – 88
	640 × 400 (NI)	30 – 40	55 – 88
	640 × 480 (NI)	30 – 66	59 – 120
	720 × 350 (NI)	30 – 40	69 – 88
	720 × 400 (NI)	30 – 40	55 – 88
SVGA	800 × 600 (NI)	34 – 76	55 – 120
	800 × 600 (I)	30 – 40	43 – 50
832 mode	832 × 624 (NI)	48 – 50	73 – 75
XGA	1024 × 768 (NI)	48 – 80	59 – 100
	1024 × 768 (I)	30 – 40	40 – 50
SUN and others	1152 × 864 (I)	40 – 60	45 – 50
	1152 × 882 (I)	40 – 60	45 – 50
	1152 × 864 (NI)	60 – 90	60 – 90
	1152 × 870 (NI)	60 – 90	60 – 90
	1152 × 882 (NI)	60 – 90	60 – 90
	1152 × 900 (NI)	60 – 90	60 – 90
SXGA	1280 × 1024 (I)	40 – 60	40 – 50
	1280 × 1024 (NI)	64 – 80	60 – 75
<p>Notes (NI): Noninterlaced (I): Interlaced The resolutions shown in bold characters (1152x864, 870, 882) are displayed with 1152x900. All values in this table assume a video frequency of 135 MHz or less.</p>			

Default Preset Timing

The monitor retains the following timing parameters for 'Clock', 'Hsync', 'Vsync' and "Total Dots" as default values. The monitor automatically selects the corresponding values to the video signal from your PC.

 The Hsync and Vsync frequencies in this table are not the only ones to be displayed. Refer to the table on page 38 for the supported frequencies. The parameters that you set through AUTO SETUP are saved in the monitor memory. Up to 25 user settings can be stored.

Screen Resolution Horiz x Vert	Timing			
	Clock (MHz)	Hsync (KHz)	Vsync (Hz)	Total Dots (HxV)
640 x 400	25.18	31.47	70.09	800 x 449
640 x 480	25.18	31.47	59.94	800 x 525
720 x 400	28.32	31.47	70.09	900 x 449
640 x 480	31.50	37.86	72.81	832 x 520
640 x 480	31.50	37.50	75.00	840 x 500
640 x 480	30.24	35.00	66.67	864 x 525
800 x 600	36.00	35.16	56.25	1024 x 625
800 x 600	40.00	37.88	60.32	1056 x 628
800 x 600	50.00	48.08	72.19	1040 x 666
800 x 600	49.50	46.88	75.00	1056 x 625
832 x 624	57.28	49.73	74.55	1152 x 667
1024 x 768 (I)	44.90	35.52	43.48	1264 x 817
1024 x 768	65.00	48.36	60.00	1344 x 806
1024 x 768	75.00	56.48	70.07	1328 x 806
1024 x 768	78.75	60.02	75.03	1312 x 800
1024 x 768	80.00	58.14	72.00	1376 x 808
1024 x 768	80.00	60.24	74.93	1328 x 804
1152 x 864 (I)	64.99	44.88	47.34	1448 x 9470
1152 x 864	80.00	59.94	59.98	1456 x 916
1152 x 864	107.67	67.29	74.77	1600 x 900
1152 x 870	100.13	68.77	75.00	1456 x 915
1152 x 900	94.50	61.85	66.00	1528 x 937
1152 x 900	108.00	71.81	76.64	1504 x 937
1280 x 1024	111.52	63.17	59.77	1765 x 1057
1280 x 1024	112.00	63.45	60.02	1765 x 1057
1280 x 1024	112.00	63.63	60.26	1760 x 1056
1280 x 1024	120.00	70.75	67.00	1760 x 1056
1280 x 1024	135.00	79.98	75.03	1688 x 1066
1280 x 1024 (I)	79.92	49.95	43.43	1600 x 1149
1280 x 1024	117.00	71.69	67.19	1632 x 1067
1280 x 1024	135.00	81.13	76.11	1664 x 1066

(I): Interlace mode

Video Adapters

Adapters for RS/6000

The following are examples of Video Adapters for RS/6000 :

- POWER Gt3i Video Adapter
- POWER Gt4, POWER Gt4x, POWER Gt4e, POWER Gt4i, POWER Gt4xi Video Adapters
- POWER GXT150, POWER GXT150M, POWER GXT150L, POWER GXT150P Video Adapters
- POWER GXT500, POWER GXT500D Video Adapters
- POWER GXT1000 Video Adapter
- POWER GXT110P Video Adapter
- POWER GXT250P, POWER GXT255P Video Adapters
- POWER GXT500P, POWER GXT550P Video Adapters
- POWER GXT800P Video Adapter
- E15/S15 Video Adapter

PC Video Adapters

The following are examples of Video Adapters for PCs :

- #9 FX Motion 771 Video Adapter (Number Nine Visual Tec. Co.)
- #9 Imagine 128 Pro Series 1 (Number Nine Visual Tec. Co.)
- ATI 3D EXPRESSION
- MGA Millenium 4 MB VRAM (Matrox Graphics Inc.)
- MGA Mystique (Matrox Graphics Inc.)

PC750, PC720, PC330, Aptiva series, or other IBM PCs that have installed the following video chips or the Millenium video cards manufactured by Matrox Graphics Inc.

- ATI 3D RAGE
- Cirrus GD5436
- Cirrus GD5446
- S3 Vision 864
- S3 Trio 64V+
- Trident 9680XGI

NEC PC-98 series only, which supports the mode of the 640×400 screen resolution and the 31.5 KHz horizontal frequency.

Video Cables

For PC and Sun workstations:

System	Part Number	Connector to System Unit	Connector to 9516 Monitor
PC	58F2901	15 pin D-Sub	5 x BNC
Sun workstation	Video cable for Sun	For Sun	5 x BNC or 4 x BNC

For RS/6000:

Graphic Adapter	Part Number	Feature Number	Connector to System	Connector to 9516 Monitor
E15	58F2901	4217	15-D	5×BNC
GT3/GT4 series	58F2903	N/A	13W3	3×BNC
GXT110P	58F2901	4217	15-D	5×BNC
GXT150 series	09G3539	4214	13W3	3×BNC
GXT150M	09G3539	4214	13W3	3×BNC
GXT250P/255P	39H8682	4239	15-D	3×BNC
GXT500/500D	09G3539	4214	13W3	3×BNC
GXT500P/550P	09G3539	4214	13W3	3×BNC
GXT800P	58F2901	4217	15-D	5×BNC
GXT1000	09G3539	4214	13W3	3×BNC
S15	58F2901	4217	15-D	5×BNC

Compliances

Federal Communications Commission (FCC) Statement

This equipment has been tested and found to comply with the limits for a Class A digital device, pursuant to Part 15 of the FCC Rules. These limits are designed to provide reasonable protection against harmful interference when the equipment is operated in a commercial environment. This equipment generates, uses, and can radiate radio frequency energy and, if not installed and used in accordance with the instruction manual, may cause harmful interference to radio communications. Operation of this equipment in a residential area is likely to cause harmful interference in which case the user will be required to correct the interference at his own expense.

Properly shielded and grounded cables and connectors must be used in order to meet FCC emission limits. IBM is not responsible for any radio or television interference caused by using other than recommended cables and connectors or by unauthorized changes or modifications to this equipment. Unauthorized changes or modifications could void the user's authority to operate the equipment.

This device complies with Part 15 of the FCC Rules. Operation is subject to the following two conditions: (1) this device may not cause harmful interference, and (2) this device must accept any interference received, including interference that may cause undesired operation.

Power Cords

For your safety, IBM provides a power cord with a grounded attachment plug to use with this IBM product. To avoid electrical shock, always use the power cord and plug with a properly grounded power outlet.

IBM power cords used in the United States and Canada are listed by the Underwriters Laboratories (UL) and certified by the Canadian Standards Association (CSA).

For units intended to be operated at 115 volts: Use a UL listed and CSA certified cord set consisting of a minimum 18 AWG, type SVT or SJT, three conductor cord, a maximum of 4.5 metres (15 feet) in length and a parallel blade, grounding type attachment plug rated 15 amperes, 125 volts.

For units intended to be operated at 230 volts (U.S. use): Use a UL listed and CSA certified cord set consisting of a

minimum 18 AWG, type SVT or SJT, three conductor cord, a maximum of 4.5 metres (15 feet) in length and a tandem blade, grounding type attachment plug rated 15 amperes 250 volts.

For units intended to be operated at 230 volts (outside the U.S.): Use a cord set with a grounding type attachment plug rated 13 amperes (minimum), 250 volts. The cord set should be marked <HAR> and have the appropriate safety approvals for the country in which the equipment will be installed.



As an ENERGY STAR Partner, IBM Corporation has determined that this product meets the ENERGY STAR guidelines for energy efficiency.



This monitor complies with TCO'92 guidelines.

MPRII

This product complies with Swedish National Council for Metrology (MPR) standards issued in December 1990 (MPRII) for very low frequency (VLF) and extremely low frequency (ELF).

Hinweise

Gemäß der Amtsblätter des BMPT Nm. 61/1991 und 6/1992 wird der Betreiber darauf aufmerksam gemacht, daß die von ihm mit diesem Gerät zusammengestellte Anlage auch den technischen Bestimmungen dieser Amtsblätter genügen muß.

Aus ergonomischen Gründen wird empfohlen, die Grundfarbe Blau nicht auf dunklem Untergrund zu verwenden (schlechte Erkennbarkeit, Augenbelastung bei zu geringem Zeichenkontrast).

Aus ergonomischen Gründen sollten nur Darstellungen auf dunklem Hintergrund bei Vertikalfrequenzen ab 60 Hz (ohne Zeilensprung) benutzt werden.

Die Konvergenz des Bildes kann sich auf Grund des Magnetfeldes am Ort der Aufstellung aus der korrekten Grundeinstellung verändern. Zur Korrektur empfiehlt es sich deshalb, die Regler an der Frontseite für H STAT und V STAT so einzustellen, daß die getrennt sichtbaren Farblinien für Rot, Grün und Blau bei z.B. der Darstellung eines Buchstabens zur Deckung (Konvergenz) gelangen. Siehe hierzu auch die Erklärungen zu H STAT und V STAT.

**Industry Canada
Compliance
Statement**

This Class A digital apparatus meets the requirements of the Canadian Interference-Causing Equipment Regulations.

Cet appareil numérique de la classe A respecte toutes les exigences du Règlement sur le matériel brouilleur du Canada.

**European Union (EU)
Statement**

This product has been tested and found to comply with the limits for Class A Information Technology Equipment according to CISPR 22 / European Standard EN 55022. The limits for Class A equipment were derived for commercial and industrial environments to provide reasonable protection against interference with licensed communication devices.

Warning: This is a Class A product. In a domestic environment this product may cause radio interference in which case the user may be required to take adequate measures.

Properly shielded and grounded cables and connectors must be used in order to reduce the potential for causing interference to radio and TV communications and to other electrical or electronic equipment. Such cables and connectors are available from IBM authorised dealers.

In accordance with EN 50082-1 1992, Performance Criterion A:, it should be noted that in the presence of certain electromagnetic fields, some screen jitter may be observed.

NOM

IBM de México, S.A.
IBM 9516-Bxx TFT LCD Color Monitor
Planta de Manufactura
IBM Japan, Ltd. Yasu
800, Ichimiyake, Yasu-cho, Yasu-gun
Shiga, 520-23
Hecho en Japon
NOM-018
Consumo de Corriente 1.5 A
Frecuencia de Operacion 50/60 Hz
Rension de Alimentacion 100 - 127 V, 200 - 240 V

Warranty

USA., Canada and Puerto Rico Statement of Limited Warranty

The warranties provided by IBM in this Statement of Limited Warranty apply only to Machines you originally purchase for your use and not for resale, from IBM or an IBM authorized reseller. The term "Machine" means an IBM machine, its features, conversions, upgrades, elements, or accessories, or any combination of them. Machines are subject to these terms only if purchased in the United States or Puerto Rico, or Canada and located in the country of purchase. If you have any questions, contact IBM or your reseller.

Machine:	IBM 9516 LCD Color Monitors
Warranty Period *:	3 Years
* Elements and accessories are warranted for three months. Contact your place of purchase for warranty service information.	

Production Status

Each Machine is manufactured from new parts, or new and serviceable used parts (which perform like new parts). In some cases, the Machine may not be new and may have been previously installed. Regardless of the Machine's production status, IBM's warranty terms apply.

The IBM Warranty

IBM warrants that each Machine 1) is free from defects in materials and workmanship and 2) conforms to IBM's Official Published Specifications. IBM calculates the expiration of the warranty period from the Machine's Date of Installation. The date on your receipt is the Date of Installation, unless IBM or your reseller informs you otherwise.

During the warranty period, IBM or your reseller will provide warranty service under the type of service designated for the Machine and will manage and install engineering changes that apply to the Machine. IBM or your reseller will specify the type of service.

For a feature, conversion or upgrade, IBM or your reseller may require that the Machine on which it is installed be 1) the designated, serial-numbered Machine and 2) at an engineering-change level compatible with the feature, conversion, or upgrade. Some of these transactions (called "Net-Priced" transactions) may include additional parts and associated replacement parts that are provided on an exchange basis. All removed parts become the property of IBM and must be returned to IBM.

Replacement parts assume the remaining warranty of the parts they replace.

If a Machine does not function as warranted during the warranty period, IBM or your reseller will repair or replace it (with a Machine that is at least functionally equivalent) without charge. If IBM or your reseller is unable to do so, you may return it to your place of purchase and your money will be refunded.

If you transfer a Machine to another user, warranty service is available to that user for the remainder of the warranty period. You should give your proof of purchase and this Statement to that user.

Warranty Service

To obtain warranty service for the Machine, contact your reseller or call IBM. In the United States, call IBM at 1-800-772-2227. In Canada call IBM at 1-800-565-3344. You may be required to present proof of purchase.

The service may be 1) a "Repair" service at your location (called "On-Site") or at one of IBM's or a reseller's service locations (called "Carry-in") or 2) an "Exchange" service, either On-site or Carry-in. If in doubt, contact your point of sale.

When a type of service involves the exchange of a Machine or part, the item IBM or your reseller replaces becomes its property and the replacement becomes yours. The replacement may not be new, but will be in good working order, and at least functionally equivalent to the item replaced.

It is your responsibility to:

1. obtain authorization from the owner (for example, your lessor) to have IBM or your reseller service a Machine that you do not own;
2. where applicable, before service is provided -
 - a. follow the problem determination, problem analysis and service request procedures that IBM or your reseller provide.
 - b. secure all programs, data and funds contained in a Machine.
 - c. inform IBM or your reseller of changes in a Machine's location, and
 - d. for a Machine with exchange service, remove all features, parts, options, alterations, and attachments not under warranty service. Also the Machine must be free of any legal obligations or restrictions that prevent its exchange; and
3. be responsible for loss of, or damage to, a Machine in transit when you are responsible for the transportation charges.

Extent of Warranty

IBM does not warrant uninterrupted or error-free operation of a Machine.

Misuse, accident, modification, unsuitable physical or operating environment, improper maintenance by you, or failure caused by a product for which IBM is not responsible may void the warranties.

THESE WARRANTIES REPLACE ALL OTHER WARRANTIES, EXPRESS OR IMPLIED, INCLUDING, BUT NOT LIMITED TO, THE IMPLIED WARRANTIES OF MERCHANTABILITY AND FITNESS FOR A PARTICULAR PURPOSE. HOWEVER, SOME LAWS DO NOT ALLOW THE EXCLUSION OF IMPLIED WARRANTIES. IF THESE LAWS APPLY, THEN ALL EXPRESS AND IMPLIED WARRANTIES ARE LIMITED IN DURATION TO THE WARRANTY PERIOD. NO WARRANTIES APPLY AFTER THAT PERIOD.

In Canada, warranties include both warranties and conditions.

Some jurisdictions do not allow limitations on how long an implied warranty lasts, so the above limitation may not apply to you.

For European warranty terms and conditions refer to enclosed IBM warranty statement Part Number 72H9623.

Référez-vous à la garantie IBM N° de référence 72H9623 pour les conditions de garantie européennes.

Die europäischen Garantiebedingungen finden Sie in der beigefügten IBM-Gewährleistungserklärung, Teilenummer 72H9623.

Los términos y condiciones de las garantías en Europa se recogen en la declaración de garantía adjunta del número de pieza IBM 72H9623.

Per le condizioni e i termini di garanzia relativi ai paesi europei, consultare l'apposita dichiarazione IBM (numero di matricola 72H9623).