

**These user's setup instructions cover typical user environments. The on-screen messages may differ depending on the level of your hardware and software. In some cases you may need to vary the setup procedures.**

**For more information, refer to your computer or operating system manuals or consult your system administrator or dealer.**

**Ces instructions de configuration d'exploitation s'appliquent aux environnements d'utilisation types. Les messages affichés à l'écran peuvent varier en fonction du niveau de votre matériel et de vos logiciels informatiques. Dans certains cas, vous pouvez être amenés à changer de procédures de configuration.**

**Pour de plus amples informations à ce sujet, veuillez vous reporter aux manuels de votre ordinateur et de votre système d'exploitation, ou consultez l'administrateur de votre système ou votre revendeur.**

**Diese Einstellungsanweisungen durch den Benutzer gelten für typische Betriebsumgebungen. Die Bildschirmmeldungen können je nach Art der verwendeten Hardware und Software auch anders lauten. In einigen Fällen müssen die Einstellungsschritte unter Umständen abgeändert werden.**

**Weitere Informationen finden Sie im Computer- oder Betriebssystemhandbuch, oder wenden Sie sich an Ihren Systemadministrator oder Fachhändler.**

**En estas instrucciones de configuración se describen entornos de usuarios típicos. Los mensajes en pantalla, pueden diferir según sea el nivel del hardware y del software. En algunos casos, necesitará seguir otros procedimientos para la configuración.**

**Para obtener más información, puede consultar los manuales del ordenador o del sistema operativo o ponerse en contacto con el administrador del sistema o con el distribuidor.**

**Queste istruzioni di configurazione per l'utente coprono gli ambienti operativi comuni. I messaggi che appaiono sul video possono differire a seconda dell'hardware e del software utilizzati. In alcuni casi potrebbe essere necessario variare le procedure di configurazione.**

**Per ulteriori informazioni, fare riferimento ai manuali del computer o del sistema operativo, o consultare il proprio amministratore di sistema o il concessionario.**

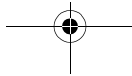

## **DANGER**

### **To avoid shock hazard:**

- Do not remove the covers.
- Do not operate this product unless the stand is attached.
- Do not connect or disconnect this product during an electrical storm.
- The power cord plug must be connected to a properly wired and grounded power outlet.
- Any equipment to which this product will be attached must also be connected to properly wired and grounded power outlets.
- To isolate the monitor from the electrical supply, you must remove the plug from the power outlet. The power outlet should be easily accessible.

## **DANGER**

### **Pour éviter les risques d'électrocution :**

- Ne retirez pas les capots du moniteur.
- N'utilisez pas ce produit si le socle n'est pas fixé.
- Ne connectez, ni ne déconnectez ce produit pendant un orage.
- Le câble d'alimentation doit être connecté à une prise électrique correctement mise à la terre et en bon état de marche.
- Tout équipement auquel ce produit est relié doit être également connecté à une prise correctement mise à la terre et en bon état de marche.
- Pour isoler le moniteur de la source d'alimentation électrique, vous devez le débrancher de la prise électrique. Cette prise doit être facile d'accès

## **GEFAHRENHINWEIS**

### **Um die Gefahr eines elektrischen Schlags zu vermeiden, folgendes beachten:**

- Unter keinen Umständen die Abdeckungen abnehmen.
- Das Produkt nicht in Betrieb nehmen, wenn der Sockel nicht montiert ist.
- Das Gerät nicht während eines Gewitters an eine Steckdose anschließen oder von ihr trennen.
- Das Netzkabel ist an eine ordnungsgemäß verdrahtete und geerdete Steckdose anzuschließen.
- Jedes Gerät, mit dem dieses Produkt verbunden wird, muß ebenfalls an eine ordnungsgemäß verdrahtete und geerdete Steckdose angeschlossen werden.
- Um den Monitor von der Stromversorgung zu trennen, muß der Stecker aus der Steckdose gezogen werden. Die Steckdose sollte leicht zugänglich sein.

## **GEVAAR**

### **Ga als volgt te werk om het gevaar van een elektrische schok te voorkomen:**

- Verwijder in geen enkel geval de kap.
- Stel dit produkt alleen in werking als de voet is bevestigd.
- Sluit dit apparaat niet aan op, of verbreek de aansluiting van dit apparaat niet van een contactdoos tijdens onweer.
- Het netsnoer moet worden aangesloten op een gearde contactdoos met correcte bedrading.
- Ook alle apparatuur waarop dit produkt wordt aangesloten moet zijn aangesloten op een contactdoos met correcte bedrading.
- Om het beeldscherm te ontkoppelen van de netvoeding, dient u de stekker uit de contactdoos te trekken. De contactdoos dient goed toegankelijk te zijn.

## **PELIGRO**

### **Para evitar riesgos de descargas eléctricas:**

- No retire bajo ningún concepto las cubiertas.
- No maneje el monitor sin antes acoplar el soporte.
- No conecte ni desconecte el equipo de una toma de alimentación durante una tormenta eléctrica.
- El cable de alimentación debe estar conectado a un enchufe debidamente cableado y con toma de tierra.
- Cualquier equipo al que se vaya a conectar este producto también debe estar conectado a tomas de alimentación cableadas y conectadas a tierra correctamente.
- Para aislar el monitor del suministro eléctrico, debe retirar el enchufe de la toma de alimentación. Esta toma deberá ser de fácil acceso.

## **PERICOLO**

### **Per evitare il rischio di scariche elettriche:**

- Non rimuovere nessuna parte del telaio.
- Non accendere il prodotto se il piedistallo non è stato montato.
- Non collegare o scollegare il prodotto nel corso di un temporale.
- La spina del cavo di alimentazione deve essere collegata ad una presa di corrente con messa a terra, installata in maniera appropriata.
- Le apparecchiature a cui il prodotto viene attaccato devono essere collegate a prese di corrente con messa a terra, installate in maniera appropriata.
- Per isolare il monitor dalla corrente elettrica, staccare la spina dalla presa di alimentazione, che deve essere facilmente accessibile.

## **PERIGO**

### **Para evitar o perigo de choques eléctricos:**

- Não retire as coberturas.
- Não utilize este produto antes de montar a base.
- Não ligue nem desligue este produto durante uma tempestade eléctrica.
- O cabo de alimentação deve ser ligado a uma tomada eléctrica devidamente ligada à terra.
- Qualquer equipamento ligado a este produto deve estar ligado a tomadas eléctricas devidamente ligadas à terra.
- Para isolar o monitor da fonte de alimentação, retire a ficha do cabo de alimentação da tomada eléctrica. A tomada eléctrica deve ser de fácil acesso.

## **FARE**

### **Sådan undgår du elektrisk stød:**

- Kabinettet må under ingen omstændigheder fjernes.
- Undgå at anvende dette produkt, uden at vippe/drejefoden er monteret.
- Undgå at tilslutte eller frakoble dette produkt i tordenvejr.
- Netledningen skal være tilsluttet en korrekt jordet stikkontakt med korrekt ledningsføring.
- Alt udstyr, som tilsluttes dette produkt, skal også være tilsluttet korrekt jordede stikkontakter med korrekt ledningsføring.
- For at isolere skærmen fra strømforsyningen, skal stikket tages ud af stikkontakten. Stikkontakten bør være let tilgængelig.

## **FARE**

### **Slik unngår du fare for elektrisk støt:**

- Ikke ta av dekslene.
- Ikke bruk produktet dersom sokkelen ikke er montert.
- Ikke koble produktet til eller fra under tordenvær.
- Pluggen på strømledningen må kobles til korrekt montert og jordet strømuttak.
- Utstyr som dette produktet eventuelt blir koblet til, må også kobles til korrekt montert og jordet strømuttak.
- For å isolere skjermen fra strømkilden må du ta ut pluggen fra strømuttaket. Strømuttaket bør være lett tilgjengelig.

## **VARNING - LIVSFARA**

### **För att undvika risk för elektriska stötar måste du tänka på följande:**

- Ta inte bort några skyddskåpor.
- Använd inte den här produkten innan du har satt fast stativet.
- Anslut inte produkten till ett eluttag under åskväder. Koppla inte heller ur produkten från ett eluttag under åskväder.
- Strömkabeln måste anslutas till ett felfritt och jordat uttag.
- All utrustning som den här produkten kopplas till måste också anslutas till felfria och jordade uttag.
- För att bryta strömmen till bildskärmen måste du dra ut kontakten. Vägguttaget bör vara lätt att komma åt.

## VAARA

### **Σδηφισκун vaaran vðlttðmiseksi:**

- Διð avaa laitteen kansia missððn tilanteessa.
- Älä käytä laitetta, ellei jalustaa ole kiinnitetty.  
Διð kytke laitetta pistorasiaan tai irrota sitä pistorasiasta ukonilman aikana.  
Virtajohto on kytkettðvð asianmukaisesti johdotettuun ja maadoitettuun pistorasiaan.  
Kaikki muutkin laitteet, joihin tðmð tuote on liitetty, on kytkettðvð asianmukaisesti johdotettuihin pistorasioihin.
- Kun haluat erottaa näyttimen sähköverkosta, sinun pitää irrottaa sen verkkojohto pistorasiasta.  
Pistorasian pitäisi olla mahdollisimman lähellä näyttintä ja vaivattomasti käsillä.

## ΚΙΝΔΥΝΟΣ

### **Για την αποφυγή κινδύνου ηλεκτροπληξίας:**

- Μην αφαιρείτε τα καλύμματα.
- Μη θέτετε το προϊόν αυτό σε λειτουργία χωρίς να είναι στερεωμένη η βάση του.
- Μη συνδέετε ή αποσυνδέετε το προϊόν αυτό κατά τη διάρκεια ηλεκτροθύελλας.
- Το φως του καλωδίου ρευματολήπτη πρέπει να συνδεθεί σε μια πρίζα με σωστή καλωδίωση και γείωση.
- Κάθε συσκευή στην οποία συνδεθεί αυτό το προϊόν πρέπει επίσης να συνδεθεί σε πρίζα με σωστή καλωδίωση και γείωση.
- Για να απομονώσετε την οθόνη από την παροχή ρεύματος, πρέπει να αφαιρέσετε το φως από την πρίζα. Η πρίζα πρέπει να είναι σε σημείο εύκολα προσβάσιμο.

## TEHLIKE

### **Elektrik çarpması tehlikesinden kaçınmak için:**

- Kapakları çıkarmayınız.
- Bu cihazı kaidesine takılı durumda değilken çalıştırmayınız.
- Bu cihazı elektriksel fırtına sırasında prize takmayınız veya prizden çıkarmayınız.
- Elektrik kablosunun fişi, elektrik ve toprak bağlantıları usulüne uygun olarak yapılmış bir prize takılmalıdır.
- Bu cihazın bağlanacağı diğer tüm cihazlar da elektrik ve toprak bağlantıları usulüne uygun olarak yapılmış prize takılmış olmalıdır.
- Monitörün elektrikle bağlantısını kesmek için fişini prizden çekmeniz gereklidir. Priz, kolayca erişilebilecek bir yerde olmalıdır.

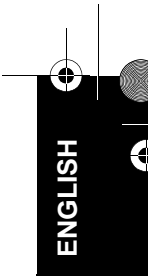

# English

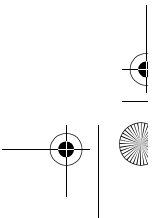
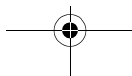
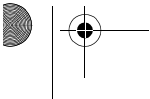

---

## First Edition (Sept/1998)

This publication could contain technical inaccuracies or typographical errors. Changes are made periodically to the information herein; these changes will be made in later editions. IBM may make improvements and/or changes in the product(s) and/or program(s) at any time.

It is possible that this publication may contain reference to, or information about, IBM products (machines and programs), programming, or services that are not announced in your country.

Requests for copies of this publication and for technical information about IBM products should be made to your IBM Authorized Dealer or IBM Retailer.

No part of this publication may be reproduced or distributed in any form or by any means without prior permission in writing from the International Business Machines Corporation.

© Copyright International Business Machines Corporation 1998. All rights reserved.

---

## Notices

References in this publication to IBM products, programs, or services do not imply that IBM intends to make these available in all countries in which IBM operates. Any reference to an IBM product, program or service is not intended to state or imply that only IBM's product, program, or service may be used. Any functionally equivalent product, program, or service that does not infringe any of IBM's intellectual property rights or other legally protectable rights may be used instead of the IBM product, program, or service. Evaluation and verification of operation in conjunction with other products, programs, or services, except those expressly designated by IBM, are the user's responsibility.

IBM may have patents or pending patent applications covering subject matter in this document. The furnishing of this document does not give you any license to these patents.

---

## Trademarks

The following terms, used in this publication, are trademarks or service marks of the IBM Corporation in the United States or other countries:

**IBMHelpCenter**

ENERGY STAR is a U.S. registered mark.



# Contents

<b>Setup</b> .....	<b>2</b>
Your IBM Digital TFT Monitor .....	2
Workplace Preparation .....	2
Working Practices .....	2
Handling Instructions .....	3
<b>Setting Up your Monitor</b> .....	<b>5</b>
Overview .....	5
Hardware Installation .....	6
Connecting your Monitor .....	8
Software Installation .....	9
Software Setup - DOS .....	10
Software Setup - Windows 95/98 .....	12
Software Setup - Windows NT 4.0 .....	14
Software Setup - OS/2 .....	16
<b>Adjusting Your LCD Monitor</b> .....	<b>18</b>
User controls .....	18
<b>Further Information</b> .....	<b>19</b>
Power Management .....	19
<b>Troubleshooting</b> .....	<b>20</b>
Further Help .....	22
<b>Specifications</b> .....	<b>27</b>

# Setup

## Your IBM Digital TFT Monitor

To provide the best performance your Digital TFT Monitor uses a digital graphics adapter which was shipped in the monitor package accessories box. You may also use your own digital graphics adapter.

## Workplace Preparation

*i* This section gives advice on what you should consider before you set up your monitor.

### Height

The monitor should be positioned so that the top of the screen is slightly below your eye level when you sit at your workstation.

### Orientation

Choose a position that gives the least reflection from lights and windows, usually at a right angle to any windows. The monitor should be positioned directly in front of you so that you do not have to twist your body to use it. Tilt the monitor to a comfortable viewing angle.

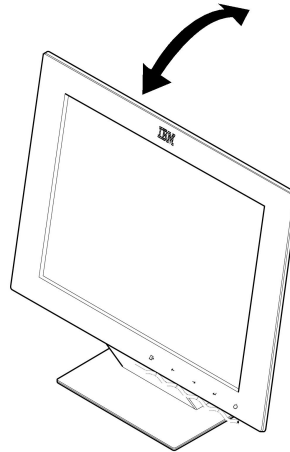

## Working Practices

*i* This section gives advice on how you can work comfortably and reduce fatigue.

### Rest

Take regular breaks. Vary your posture, stand up and stretch occasionally as prolonged use of computer workstations can be tiring.

## Back

You should sit back in your chair and use the backrest.

## Hands

Use a light touch on the keyboard, keeping your hands and fingers relaxed. Allow a space in front of the keyboard to rest your wrists when not typing. Consider using a wristpad.

## Eyesight

Working with monitors, in common with any prolonged close work, can be visually demanding. Look away from the screen periodically and have your eyesight checked regularly.

## Screen settings

Set the screen brightness and contrast to a comfortable level (see *User controls* on page 18). You may have to adjust this as the lighting changes during the day. Many application programs let you select color combinations which can help you to view in comfort.

---

## Handling Instructions

 *Do not support the monitor within the screen area. The Liquid Crystal Display is glass and can be damaged by rough handling or excessive pressure.*

1. Lift the monitor by placing both hands under the lower part of the cover.

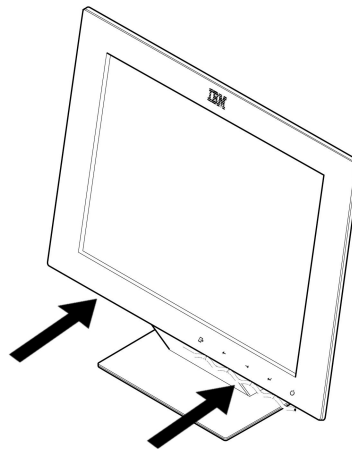

2. Before using your monitor for the first time, remove the clear protective film from the front of the screen.

### Caring for your Monitor

Be sure to turn off the power before you perform any maintenance on the monitor. Clean your monitor as follows:

- Gently wipe the device covers and the screen with a soft cloth.
- Remove finger marks and grease with a damp cloth and mild detergent; do not use solvents or abrasives.
- Never use flammable cleaning material to clean your IBM monitor or any other electrical apparatus.

# Setting Up your Monitor

## Overview

The graphics adapter included in your monitor package uses a Matrox graphics engine to help the monitor provide superior performance with Windows, digital video and 3D graphics. To further accelerate 3D programs, your graphics adapter uses bus mastering and has hardware-accelerated features, including texture mapping, Gouraud shading and Z-buffering. This graphics adapter also supports more advanced 3D features such as alpha-blending, anti-aliasing, MIP-mapping, and more. Depending on the model of your graphics adapter, it supports display addressabilities up to 1800×1440 and 1920×1200.

Your graphics adapter is 100% VGA compatible and supports all VESA standards: VBE 2.0 (Super VGA modes), DPMS (energy saving), and DDC-2B (Plug-and-Play monitors).

Also, depending on the model of your graphics adapter, you can upgrade it with more graphics memory or multimedia hardware add-ons. For more information on available upgrades, see the Matrox Web site ([www.matrox.com/mga](http://www.matrox.com/mga)).

Follow the three steps below for a successful setup of your monitor.

1. **Installing the Graphics Adapter Hardware.** To provide the best performance for your Digital TFT monitor you must install the digital graphics adapter supplied with your monitor in the accessories box. See *Hardware Installation* on page 6 for instructions.
2. **Connecting your Monitor.** Next, connect the monitor to your system unit and to a power supply outlet. See *Connecting your Monitor* on page 8 for instructions.
3. **Installing the Graphics Adapter Software.** Finally, install the display drivers provided with your monitor. See *Software Installation* on page 9 for instructions.

## Hardware Installation

**⚠** *Static electricity can severely damage electronic parts. Take these precautions:*

- *Before touching any electronic parts, drain the static electricity from your body. You can do this by touching the metal frame of your computer*
- *Don't remove a card from the anti-static container it was shipped in until you're ready to install it. When you remove a card from your computer, place it back in its container.*
- *When handling a card, hold it by its edges, and avoid touching its circuitry.*

Before you begin, ensure that your display driver is set to standard VGA mode (640 x 480) by following the table below.

Operating System	Procedure
DOS	No actions required.
Windows 95/98	No actions required.
Windows NT 4.0	Click on START, SETTINGS and then CONTROL PANEL. Double click on the DISPLAY icon. Click on the SETTINGS tab. In the Desktop Area move the marker to 640 x 480. Click OK
OS/2	Select OS/2 SYSTEM, SYSTEMS SETUP, SYSTEM. Select SCREEN RESOLUTION 640 x 480. Close SYSTEMS and restart your system.

### Remove your existing graphics adapter

1. Turn off your computer and all peripherals such as your monitor or printer and open your computer.
2. The graphics adapter is often built into your computer's motherboard so you do not need to remove any hardware. However, if there is a graphics adapter card in a separate expansion slot, you should remove it.

**⚠** *Inserting your graphics adapter into the wrong type of slot could damage your card, your computer, or both.*

### Choose an expansion slot

3. Most computers have different types of expansion slots. Choose an AGP or PCI slot, depending on the type of graphics adapter you have. Your system manual should identify the location of each type of expansion slot in your computer.

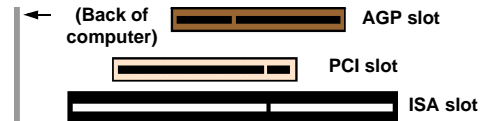

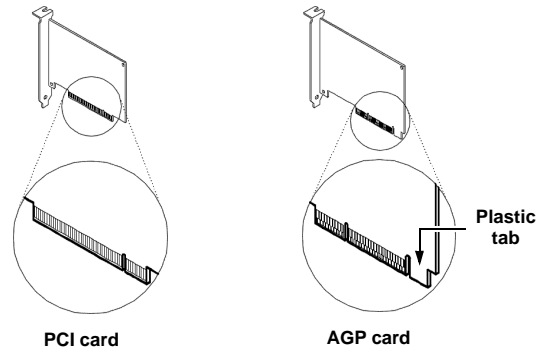

If you have an AGP card, don't insert the plastic tab next to the connector pins (see picture) into the slot.

#### Insert your graphics adapter

4. Remove the cover for the slot you intend to use. Save the screw for the mounting bracket. Position your graphics adapter over the expansion slot you've chosen. Push the card in firmly and evenly until it's fully seated in the slot. Replace the screw to secure the bracket of your graphics adapter to the computer frame.

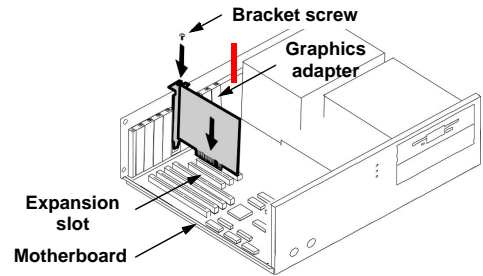

Now continue with **Connecting your Monitor** on page 8.

## Connecting your Monitor

 *Be sure to read the 'Safety Information' at the front of this User Guide before carrying out this procedure.*

 *The AC adapter and Plug-and-Display signal cable are connected to your monitor. If you wish to change these or to fit a different stand, see **Further Help** on page 22.*

 *The smaller port next to the P&D port is used for analog monitors.*

1. Turn off your PC and all attached devices.
2. Connect the Plug-and-Display (P&D) connector at the end of the signal cable to the P&D port located on the back of the graphics adapter.

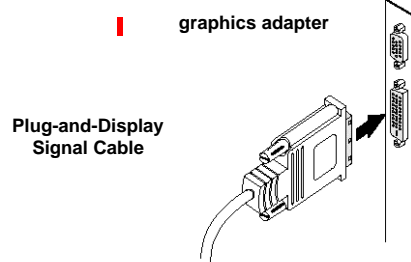
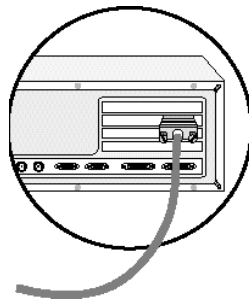

4. Connect the power cord to the power adapter first, then insert the plug into a properly grounded electrical outlet.
5. Switch on the power source and your computer. To turn on the monitor, push and release the power switch . To switch it off, push and release the power switch again.

Now, continue with **Software Installation** on page 9.



## Software Installation



*There are 7 installation diskettes in the package. Check that you have them all and take care to insert the diskette for the correct operating system when installing.*

1. Start your computer. If you're using Windows 95/98, it detects new hardware when you restart. If appropriate display drivers haven't been previously installed, Windows 95 reports finding a PCI adapter (even if you have an AGP card).
  - If you see the New Hardware Found dialog box, click "DO NOT INSTALL A DRIVER", then OK.
  - If you see the Update Device Driver Wizard dialog box, click NEXT, then FINISH.
  - If you see the Add New Hardware Wizard dialog box, click NEXT, NEXT, NEXT, NEXT, FINISH, then YES to restart your computer.
2. Insert the diskette labelled for your operating system:

Operating System	Procedure
DOS	Type MGASETUP.EXE at the A:\ prompt and press ENTER.
Windows 95/98	Click on START and then RUN. Type MGASETUP.EXE and select OK.
Windows NT 4.0	Click on START and then RUN. Type MGASETUP.EXE and select OK.
OS/2	

3. When prompted, select the language you want to use, then click NEXT.
4. If this is a first-time installation, the setup program lists the software that needs to be installed to take advantage of your new graphics adapter hardware. To begin the software installation, click INSTALL.
5. When prompted, choose an installation type:

Installation Type	Procedure
Complete MGA Matrox PowerDesk (recommended)	Click TYPICAL.
To customize the PowerDesk installation	Click CUSTOM.

If you click CUSTOM, the setup program prompts you for a destination folder and the PowerDesk options you want to install.

After you choose, the setup program automatically installs Matrox software and drivers.

6. Change the diskette according to the message and continue with installation.
7. After setup, remove the diskette in your drive A:, then click OK to restart your computer and for all changes to take effect.
8. If this is a first-time installation, your display is using a 640 x 480 display mode with 256 colors. To adjust software monitor settings:
  - for DOS, see **Software Setup - DOS** on page 10.
  - for Windows 95/98, see **Software Setup - Windows 95/98** on page 12
  - for Windows NT 4.0, see **Software Setup - Windows NT 4.0** on page 14.
  - for OS/2, see **Software Setup - OS/2** on page 16.

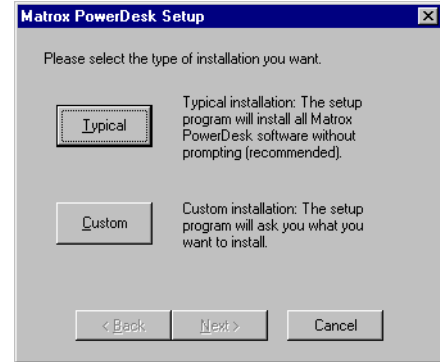

## Software Setup - DOS

To access Matrox PowerDesk programs and on-line documentation, type MGA.EXE in the DOS prompt and press Enter.

### Monitor setup

To check your monitor settings:

1. Click the MATROX DISPLAY PROPERTIES menu item and then click the MONITOR tab.
2. Click the Matrox monitor button, select T55D in the list below this button, then click OK to let the MGA Matrox display driver automatically use the correct settings for your monitor.

### Display setup

After checking your monitor's software settings, you can change your display resolution, color palette and other MGA Matrox PowerDesk settings. To access Matrox display property sheets,

1. Click the **MATROX DISPLAY PROPERTIES** menu item and then click the **SETTINGS** tab. For more information on changing your display settings, see the on-line MGA Matrox PowerDesk guide.

### Software overview



MGA Matrox PowerDesk for DOS includes;

- MGA Matrox display driver with:
  - DirectDraw and Direct3D support for direct access to Matrox hardware.
  - Plug-and-Play (DDC-2B) and ENERGY STAR® (DPMS) support.
- Settings property sheet to change your display settings. Use this sheet to access Matrox PowerDesk features such as:
  - Display schemes to easily switch to a pre-defined display setting.
  - Performance property sheet to change Matrox display driver performance settings.
  - Utilities property sheet to configure Matrox PowerDesk options.
- Monitor property sheet to inform the MGA Matrox display driver of your monitor's capabilities.
- Color property sheet to change your display's color balance.
- Hot Key property sheet to define keyboard shortcuts for:
  - PanEND to move your display area to the right or bottom of your virtual desktop.
  - PanHOME to move your display area to the left or top of your virtual desktop.
  - PanLOCK to enable or disable panning.
  - PixelTOUCH to magnify part of your desktop area.
- Your favorite display schemes.
- Information property sheet for information on your display hardware and software.

## Software Setup - Windows 95/98

**i** The Matrox display driver for Windows 95/98 supports multiple displays with Windows 98. However, Matrox PowerDesk features are disabled in multi-display mode. To change your display settings while in multi-display mode, use Windows controls. For more information on multi-display mode, see Windows 98 on-line Help under "Multiple Display support".

**i** Many Plug-and-Play monitors don't automatically report whether they are capable of 1152 x 864, or 1600 x 1200 and higher display addressabilities. To use these addressabilities, or higher refresh rates than those reported by the monitor, you can use the MGA Matrox monitor selection method.

To access Matrox PowerDesk programs and on-line documentation, click  → PROGRAMS → MGA MATROX POWERDESK. You can access commonly used PowerDesk features by right-clicking the Windows desktop background, then clicking MATROX DISPLAY PROPERTIES. You can also access PowerDesk features by clicking the Matrox QuickDesk icon  on the Windows taskbar.

### Monitor setup

To check your monitor settings

1. Click  → PROGRAMS → MATROX POWERDESK → MATROX DISPLAY PROPERTIES → MONITOR.
2. If you have a Plug-and-Play monitor:

Make sure the Windows 95 monitor button is selected and T55D appears immediately under it. The MGA Matrox display driver automatically uses the correct settings for your monitor.



### Display setup

After checking your monitor's software settings, you can change your display resolution, color palette and other MGA Matrox PowerDesk settings. To access MGA Matrox display property sheets, click  → PROGRAMS → MGA MATROX POWERDESK → MATROX DISPLAY PROPERTIES. To change your display resolution or color palette, click the Settings tab. For more information on changing your display settings, see the on-line MGA Matrox PowerDesk guide.



### Software overview

MGA Matrox PowerDesk for Windows 95/98 includes:

- MGA Matrox display driver with:
  - DirectDraw and Direct3D support for direct access to Matrox hardware.
  - Plug-and-Play (DDC-2B) and Energy Star (DPMS) support.
- Settings property sheet to change your display settings. Use this sheet to access Matrox PowerDesk features such as:
  - Desktop mode buttons to set up a proportional, horizontal or vertical *virtual desktop*
  - Display schemes to easily switch to a pre-defined display settings.

- Performance property sheet to change MGA Matrox display driver performance settings.
- Utilities property sheet to configure MGA Matrox PowerDesk options.
- Monitor property sheet to inform the MGA Matrox display driver of your monitor's capabilities. You can use this sheet instead of the Windows 95 method of monitor selection.
- Color property sheet to change your display's color balance.
- Hot Key property sheet to define keyboard shortcuts for:
  - CenterWINDOW to center your view area on the active window.
  - MaxVIEW to resize the active program window to the size of your current display area.
  - PanEND to move your display area to the right or bottom of your virtual desktop.
  - PanHOME to move your display area to the left or top of your virtual desktop.
  - PanLOCK to enable or disable panning.
  - PixelTOUCH to magnify part of your desktop area.
  - Your favorite display schemes.
- Information property sheet for information on your display hardware and software.

## Software Setup - Windows NT 4.0

To access PowerDesk programs and on-line documentation, click  → PROGRAMS → MATROX POWERDESK NT or click Matrox QuickDesk icon  on the Windows taskbar.

### Monitor setup

To check your monitor settings

1. Click  → PROGRAMS → MATROX POWERDESK NT → MATROX DISPLAY PROPERTIES → MONITOR.

2. If you have a Plug-and-Play monitor:

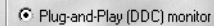

Make sure the Plug-and-Play (DDC) monitor button is selected. If so, the MGA Matrox display driver automatically uses the correct settings for your monitor. If not, click this button, then click APPLY.

### Display setup

After checking your monitor's software settings, you can change your display resolution, color palette and other MGA Matrox PowerDesk settings. To access MGA Matrox display property sheets, click  → PROGRAMS → MATROX POWERDESK NT → MATROX DISPLAY PROPERTIES. To change your display resolution or color palette, click the SETTINGS tab. For more information on changing your display settings, see the MGA Matrox PowerDesk on-line guide.

### Software overview

MGA Matrox PowerDesk for Windows NT 4.0 includes:

- MGA Matrox display driver with:
  - Multi-display support to use up to 5 monitors at a time (one monitor for each Matrox card - of the same type - in your computer)
  - Accelerated DirectDraw and OpenGL support for direct access to Matrox hardware.
  - Plug-and-Play (DDC-2B) monitor support.
- Settings property sheet to change your display settings. This sheet provides access to Matrox PowerDesk features such as:
  - Desktop mode buttons to set up a proportional, horizontal or vertical virtual desktop.

 Many Plug-and-Play monitors don't automatically report whether they are capable of 1152 × 864 or 1600 × 1200 and higher display addressabilities. To use these addressabilities, or higher refresh rates than those reported by the monitor, you can use the MGA Matrox monitor selection method.

- Display schemes to easily switch to a pre-defined display setting.
- Monitor property sheet to inform the MGA Matrox display driver of your monitor's capabilities.
- Information property sheet to display hardware and software version numbers and capabilities.
- Performance property sheet to configure advanced driver performance settings.
- PowerDesk property sheet with settings for:
  - PixelTOUCH to zoom in and pan on your viewing area.
  - CenterWINDOW to center opened windows in your viewing area.
  - MaxVIEW to maximize windows in your viewing area instead of your desktop.
  - CenterPOPUP to have new windows pop up in the center of your current viewing area.

## Software Setup - OS/2

To access PowerDesk programs and on-line documentation, right-click on the PM desktop background and choose **MATROX POWERDESK**. You can also access PowerDesk features by clicking the Matrox QuickDesk icon.

### Monitor setup

To check your monitor settings

1. Right-click the PM desktop background, then click the **MATROX POWERDESK** → **MATROX DISPLAY PROPERTIES** → **MONITOR**.
2. For the T55D monitor:

Make sure the Plug-and-Play (DDC) monitor button is selected. If so, the MGA Matrox display driver automatically uses the correct settings for the T55D.

### Display setup

After checking your monitor's software settings, you can change your display resolution, color palette and other MGA Matrox PowerDesk settings. To access MGA Matrox display property sheets, right-click the PM desktop background, then click **MATROX POWERDESK** → **MATROX DISPLAY PROPERTIES**. To change your display resolution or color palette, click the **SETTINGS** tab. For more information on changing your display settings, see the MGA Matrox PowerDesk on-line guide.

### Software overview

MGA Matrox PowerDesk for OS/2 includes

- MGA Matrox display driver with:
  - Multi-display support to use up to 5 monitors at a time (one monitor for each Matrox card - of the same type - in your computer)
  - Accelerated DirectDraw and OpenGL support for direct access to Matrox hardware.
  - Plug-and-Play (DDC-2B) monitor support.
- Settings property sheet to change your display settings. This sheet provides access to Matrox PowerDesk features such as:
  - Desktop mode buttons to set up a proportional, horizontal or vertical virtual desktop.
  - Display schemes to easily switch to a pre-defined display setting.

***i** Many Plug-and-Play monitors don't automatically report whether they are capable of 1152 × 864 or 1600 × 1200 and higher display addressabilities. To use these addressabilities, or higher refresh rates than those reported by the monitor, you can use the MGA Matrox monitor selection method.*



- Monitor property sheet to inform the MGA Matrox display driver of your monitor's capabilities.
- Information property sheet to display hardware and software version numbers and capabilities.
- Performance property sheet to configure advanced driver performance settings.
- PowerDesk property sheet with settings for:
  - PixelTOUCH to zoom in and pan on your viewing area.
  - CenterWINDOW to center opened windows in your viewing area.
  - MaxVIEW to maximize windows in your viewing area instead of your desktop.
  - CenterPOPUP to have new windows pop up in the center of your current viewing area.

# Adjusting Your LCD Monitor

## User controls



### User control features

Icon	Control	Description
	Min	Minimize the brightness
	Decrease	Fine-adjust the brightness
	Increase	
	Max	Maximize the brightness
	Power Switch	Switch the monitor on and off

### Brightness

*The brightness is already optimized for normal office settings. However, you can adjust the monitor to your liking or for specific environments such as for bright daylight operation or night operation.*

*The brightness setting is remembered next time the monitor is turned on.*

Unlike analog monitors, your digital TFT monitor needs no picture adjustment except the brightness level. To adjust the brightness of the image;

- Press the Min or Max buttons to set the brightness to its minimum or maximum value.
- Press Decrease or Increase to make small adjustments to the brightness to suit your liking.

## Further Information

### Power Management

To benefit from power management, the monitor must be used in conjunction with a computer that implements the Video Electronics Standards Association (VESA) Display Power Management Signalling (DPMS) Standard.

The power management feature is invoked when the computer recognizes that you have not used your mouse or keyboard for a user-definable period. There are several states as described in the table below.

As an ENERGY STAR<sup>®</sup> Partner, IBM has determined that this product meets the ENERGY STAR<sup>®</sup> guidelines for energy efficiency.

IBM recommends that you switch off your monitor at the end of each working day, or whenever you expect to leave it unused for long periods during the day.

State	Power Indicator	Screen	Restoring Operation	Compliance
<b>On</b>	Steady green	Normal		
<b>DPMS Standby</b>	Steady amber	Blank	Press a key or move the mouse.	ENERGY STAR <sup>®</sup> and NUTEK
<b>DPMS Suspend</b>	Flashing amber (0.5 sec. interval)	Blank	Press a key or move the mouse. ‡	ENERGY STAR <sup>®</sup> and NUTEK
<b>DPMS Off</b>	Flashing amber (1 sec. interval)	Blank	Press a key or move the mouse. ‡	ENERGY STAR <sup>®</sup> and NUTEK

‡ There may be a slight delay before the picture reappears.

# Troubleshooting

---

If you have a problem setting up or using your monitor, you may be able to solve it yourself. Before calling your retailer or IBM, try the suggested actions that are appropriate to your problem.

Problem	Possible Cause	Suggested Action	Reference
Computer doesn't boot after the graphics adapter is installed	There is another graphics adapter in the computer	Remove the other graphics adapter plugged into one of the expansion slot. If the card is built-in to the motherboard, check your system manual for instructions on how to disable the built-in adapter.	See <b>Hardware Installation</b> section on page 6
The screen image is garbled or unusable (rolling screen images, overlapping screen images or a blank screen)	The display driver is trying to use a setting your monitor doesn't support	Select the correct monitor again.	See <b>Hardware Installation</b> section on page 6
Screen is blank and power indicator is off	No power to monitor	Ensure that the electrical outlet and the monitor are both switched on. Check that the power cord is firmly plugged into the electrical outlet and the power supply unit. If the power cord plug has a removable fuse, replace it. Try another power cord. Try another electrical outlet.	<b>Connecting your Monitor</b> section on page 8

Problem	Possible Cause	Suggested Action	Reference
Screen is blank and power indicator is steady green	Brightness may be too low	Adjust brightness.	<b>User controls</b> section on page 18
Screen is blank and power indicator is steady amber	The monitor is in the Power Management Standby state	Press any key on the keyboard or move the mouse to restore operation. Check the Power Management software on your computer.	<b>Power Management</b> section on page 19
Screen is blank and power indicator is Flashing green every 0.5 second	Display mode of the computer is outside the range of the monitor	Reconfigure the computer to use a supported display mode.	<b>Software Installation</b> section on page 9
	The monitor is not receiving a video signal	Check that the signal cable is firmly connected to the computer. Check that no pins are bent in the signal cable connector.	<b>Connecting your Monitor</b> section on page 8
Screen is blank and power indicator is flashing amber every 0.5 or 1 second	The monitor is in the Power Management Suspend or Off state	Press any key on the keyboard or move the mouse to restore operation. Check the Power Management software on your computer.	<b>Power Management</b> section on page 19
A few dots are missing, discolored, or inappropriately lighted.	The LCD contains over 2,300,000 thin-film transistors (TFTs). A small number of missing, discolored, or lighted dots may be present on the screen, which is an intrinsic characteristic of the TFT LCD technology and is not an LCD defect.		

## Further Help

If you are unable to correct the problem yourself, you may seek further help as follows:

Call the IBM HELPCENTER.

In the US call 1-800-772-2227

In Canada call 1-800-565-3344

In other countries contact your dealer, retailer, or other IBM authorized Servicer.

***i** If possible, stay by your computer. Your Technical Support Representative may wish to go through the problem with you during the call.*

Before calling, please have available as much of the following information as possible:

1. Model and serial number from the label on your monitor.
2. Purchase receipt.
3. Description of problem.
4. Computer type and model.
5. System configuration (hardware fitted, etc.).
6. System BIOS version number.
7. Operating System and version number.
8. Display driver version number.
9. Graphics adapter type.

***i** More help, late-breaking news and details of the latest accessories for these products may be found on the worldwide web at:*

*<http://www.pc.ibm.com/us/accessories>*

*Information about the Video Electronics Standards Association can be found on the worldwide web at:*

*<http://www.vesa.org>*

### Removing the stand and cables

Alternative stands for your IBM Flat Panel Monitor may be available from specialist suppliers.

This product is equipped with mounting facilities that conform to the VESA Flat Panel Monitor Physical Mounting Interface Standard (FPMPMI).

This product is shipped with the signal cable and the power cord attached to the monitor. If you want to use other cables for reasons such as having the monitor wall-mounted, follow the instructions below:

1. Disconnect the power cord from the wall outlet.

2. Squeeze the sides of the hinge cover (b) and pull it and the cable cover (a) off.

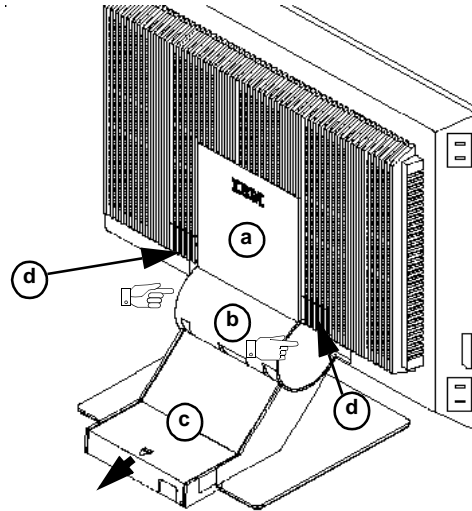

3. Gently lift the stand cover (c) along the top and then slide it backwards and off the stand.
4. Remove the signal cable and the power cord from the monitor by disconnecting the corresponding adapters. Carefully cut the plastic tie to free the power cord and remove the screw holding the power cord clamp.
5. Lay the monitor facedown on a cushion and remove the six screws holding the hinge mechanism on the monitor. Lift off the hinge and base assembly.
6. Insert your finger in the slot of one of the two VESA caps (d) and pull the cap off. Repeat the procedure on the other VESA cap.

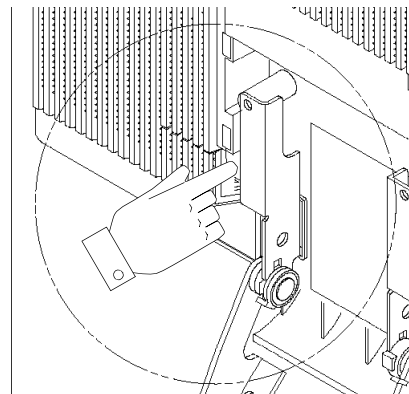

7. If you are installing an arm or wall-mounting device, follow the directions included with the device. If you are just changing your cables, continue with Step 8.
8. Connect the signal cable and the power cord, then refit the power cord clamp in its original screwpost.
9. Slide the stand cover back on the stand.
10. Put the hinge cover back on, making sure that the straight side is at the top.
11. Insert the three tabs at the top of the cable cover into the slots in the back of the monitor and push the cover into place.

To obtain the correct cables and/or to get further instructions on installing them, call the IBM HELPCENTER at the above numbers or contact your dealer, retailer, or other IBM authorized Servicer.



## Opening your IBM Computer

1. If a cover lock is present, unlock the computer cover. (The cover lock is located on the rear of the computer in some models).

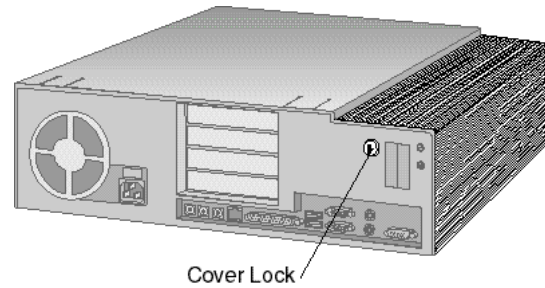

2. Find the tabs on the rear of the computer cover and lift them up; then gently pull the cover toward you to release the back edge. Next, hold the cover by the sides and pull it forward about half an inch.

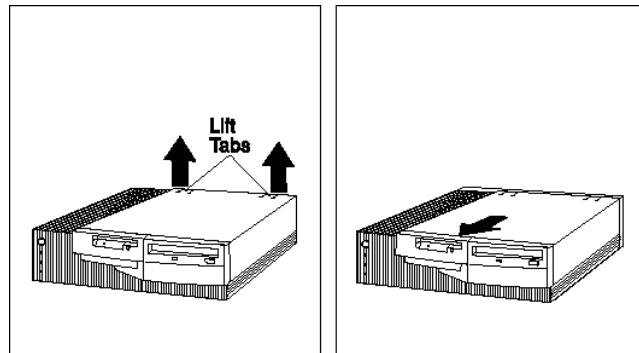

3. Lift the back edge and slide the cover forward until it comes free.

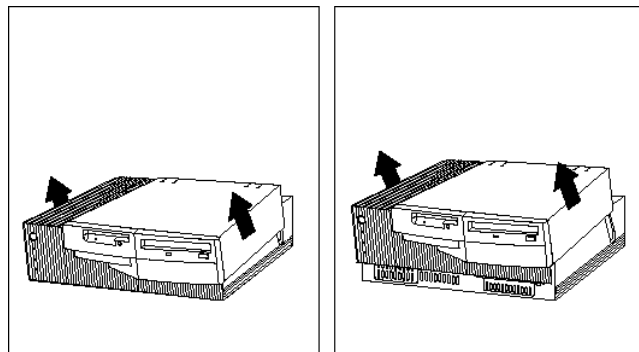

4. The following illustration is for reference only, but it may help you locate components.

- 1** Drive bay 1
- 2** Drive bay 2
- 3** Drive bay 3
- 4** Drive bay 4
- 5** Client LAN Light
- 6** Hard disk drive light
- 7** Power-on light
- 8** On-off switch
- 9** System board
- 10**
- 11** Riser card with expansion slots

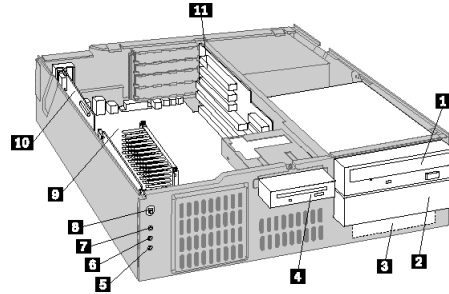

# Specifications

This color monitor (Type-model 9513-Dxx) uses a 15-inch digital TFT LCD.

Dimensions	Width: Depth: Height:	413 mm 204 mm 381 mm
Weight		14.3 lb. (6.5 Kg)
Tilt	Forward Tilt: Backward tilt:	- 4° + 41°
Image	Viewable Image Size: Maximum Height: Maximum Width: Pixel Pitch:	15.0" (381 mm) 228 mm 304 mm 0.297 mm (H) × 0.297 mm (V)
Power Input	Supply Voltage: Max Supply Current:	90 - 260 Vac 60/50 ± 3 Hz 1.0 A at 120 Vac
Power Consumption	Normal Operation: DPMS Stand-by: DPMS Suspend: DPMS off:	< 40 W < 5 W < 5 W < 5 W
Video Input	Input Signal: Horiz. Addressability: Vert. Addressability: Clock Frequency:	VESA TMDS (Panel-Link) 1024 pixels (max) 768 lines (max) 65 MHz
Communications	VESA DDC:	2 B
Environment	Temperature: Operating: Storage: Shipping: Humidity: Operating: Storage: Shipping:	10 to 35° C - 20 to 60° C - 20 to 60° C 10 to 80% 5 to 95% 5 to 95%

*i* Power consumption figures are for the monitor and the power supply combined.

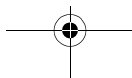

# Compliances

## Federal Communications Commission (FCC) Statement

This equipment has been tested and found to comply with the limits for a Class B digital device, pursuant to Part 15 of the FCC Rules. These limits are designed to provide reasonable protection against harmful interference in a residential installation. This equipment generates, uses, and can radiate radio frequency energy and, if not installed and used in accordance with the instructions, may cause harmful interference to radio communications. However, there is no guarantee that interference will not occur in a particular installation. If this equipment does cause harmful interference to radio or television reception, which can be determined by turning the equipment off and on, the user is encouraged to try to correct the interference by one or more of the following measures:

- Reorient or relocate the receiving antenna.
- Increase the separation between the equipment and receiver.
- Connect the equipment into an outlet on a circuit different from that to which the receiver is connected.
- Consult an IBM authorized dealer or service representative for help.

Properly shielded and grounded cables and connectors must be used in order to meet FCC emission limits. Proper cables and connectors are available from IBM authorized dealers. IBM is not responsible for any radio or television interference caused by using other than recommended cables and connectors or by unauthorized changes or modifications to this equipment. Unauthorized changes or modifications could void the user's authority to operate the equipment.

### Declaration of Conformity

<b>Trade Name:</b>	IBM Corporation
<b>Model No.:</b>	9513-DGx, 9513-DWx
<b>Responsible Party:</b>	Samsung Electronics Co., Ltd.
<b>Address:</b>	QA Lab of Samsung America 85 West Tasman Drive San Jose, CA 95134 USA
<b>Telephone:</b>	408-554-5124
<b>Fax:</b>	408-554-5191

This device complies with Part 15 of the FCC Rules. Operation is subject to the following two conditions: (1) this device may not cause harmful interference, and (2) this device must accept any interference received, including interference that may cause undesired operation.

## Power Cords

For your safety, IBM provides a power cord with a grounded attachment plug to use with this IBM product. To avoid electrical shock, always use the power cord and plug with a properly grounded power outlet.

IBM power cords used in the United States and Canada are listed by the Underwriters Laboratories (UL) and certified by the Canadian Standards Association (CSA).

For units intended to be operated at 115 volts: Use a UL listed and CSA certified cord set consisting of a minimum 18 AWG, type SVT or SJT, three conductor cord, a maximum of 4.5 meters (15 feet) in length and a parallel blade, grounding type attachment plug rated 15 amperes, 125 volts.

For units intended to be operated at 230 volts (U.S. use): Use a UL listed and CSA certified cord set consisting of a minimum 18 AWG, type SVT or SJT, three conductor cord, a maximum of 4.5 meters (15 feet) in length and a tandem blade, grounding type attachment plug rated 15 amperes 250 volts.

For units intended to be operated at 230 volts (outside the U.S.): Use a cord set with a grounding type attachment plug rated 13 amperes (minimum), 250 volts. The cord set should be marked <HAR> and have the appropriate safety approvals for the country in which the equipment will be installed.



As an ENERGY STAR® Partner, IBM Corporation has determined that this product meets the ENERGY STAR guidelines for energy efficiency.



This monitor complies with TCO'95 guidelines.

## MPRII

This product complies with Swedish National Council for Metrology (MPR) standards issued in December 1990 (MPRII) for very low frequency (VLF) and extremely low frequency (ELF).

## Hinweise

Gemäß der Amtsblätter des BMPT Nm. 61/1991 und 6/1992 wird der Betreiber darauf aufmerksam gemacht, daß die von ihm mit diesem Gerät zusammengestellte Anlage auch den technischen Bestimmungen dieser Amtsblätter genügen muß.

Aus ergonomischen Gründen wird empfohlen, die Grundfarbe Blau nicht auf dunklem Untergrund zu verwenden (schlechte Erkennbarkeit, Augenbelastung bei zu geringem Zeichenkontrast).

Aus ergonomischen Gründen sollten nur Darstellungen auf dunklem Hintergrund bei Vertikalfrequenzen ab 60 Hz (ohne Zeilensprung) benutzt werden.

Die Konvergenz des Bildes kann sich auf Grund des Magnetfeldes am Ort der Aufstellung aus der korrekten Grundeinstellung verändern. Zur Korrektur empfiehlt es sich deshalb, die Regler an der Frontseite für H STAT und V STAT so einzustellen, daß die getrennt sichtbaren Farblinien für Rot, Grün und Blau bei z.B. der Darstellung eines Buchstabens zur Deckung (Konvergenz) gelangen. Siehe hierzu auch die Erklärungen zu H STAT und V STAT.

## Industry Canada Compliance Statement

This Class B digital apparatus meets the requirements of the Canadian Interference-Causing Equipment Regulations.

Cet appareil numérique de la classe B respecte toutes les exigences du Règlement sur le matériel brouilleur du Canada.

## NOM

IBM de México, S.A.  
IBM 9513-Axx TFT LCD Color Monitor  
Planta de Manufactura  
416, Maetan-3Dong, Paldal-Gu  
Suwon City, Kyungki-Do, Korea  
442-742  
Hecho en Korea  
**NOM** - 018  
Consumo de Corriente 1.5 A  
Frecuencia de Operacion 50/60 Hz  
Rension de Alimentacion 100-240 V

## European Union (EU) Statement

This product has been tested and found to comply with the limits for Class B Information Technology Equipment according to CISPR 22 / European Standard EN 55022. The limits for Class B equipment were derived for typical residential environments to provide reasonable protection against interference with licensed communication devices.

Properly shielded and grounded cables and connectors must be used in order to reduce the potential for causing interference to radio and TV communications and to other electrical or electronic equipment. Such cables and connectors are available from IBM authorised dealers.

In accordance with EN 50082-1 1992, Performance Criterion A<sub>1</sub>, it should be noted that in the presence of certain electromagnetic fields, some screen jitter may be observed.

# Warranty

---

For European warranty terms and conditions, refer to the enclosed IBM Warranty statement, Part Number 72H9623.

## Statement of Limited Warranty

The warranties provided by IBM in this Statement of Limited Warranty apply only to Machines you originally purchase for your use, and not for resale, from IBM or your reseller. The term "Machine" means an IBM machine, its features, conversions, upgrades, elements, or accessories, or any combination of them. Unless IBM specifies otherwise, the following warranties apply only in the country where you acquire the Machine. If you have any questions, contact IBM or your reseller.

<b>Machine:</b>	IBM 9513 LCD Color Monitors
<b>Warranty Period*:</b>	3 years, including backlight
	<ul style="list-style-type: none"><li>• Contact your place of purchase for warranty service information</li></ul>

## Production Status

Each Machine is manufactured from new parts, or new and serviceable used parts (which perform like new parts). In some cases, the Machine may not be new and may have been previously installed. Regardless of the Machine's production status, IBM's warranty terms apply.

## The IBM Warranty

IBM warrants that each Machine 1) is free from defects in materials and workmanship and 2) conforms to IBM's Official Published Specifications. The warranty period for a Machine is a specified, fixed period commencing on its Date of Installation. The date on your receipt is the Date of Installation, unless IBM or your reseller informs you otherwise.

During the warranty period IBM or your reseller, if authorized by IBM, will provide warranty service under the type of service designated for the Machine and will manage and install engineering changes that apply to the Machine.

For IBM or your reseller to provide warranty service for a feature, conversion, or upgrade, IBM or your reseller may require that the Machine on which it is installed be 1) for certain Machines, the designated, serial-numbered Machine and 2) at an engineering-change level compatible with the feature, conversion, or upgrade. Many of these transactions involve the removal of parts and their return to IBM. You represent that all removed parts are genuine and unaltered. A part that replaces a removed part will assume the warranty service status of the replaced part.

If a Machine does not function as warranted during the warranty period, IBM or your reseller will repair it or replace it with one that is at least functionally equivalent, without charge. The replacement may not be new, but will be in good working order. If IBM or your reseller is unable to repair or replace the Machine, you may return it to your place of purchase and your money will be refunded.



If you transfer a Machine to another user, warranty service is available to that user for the remainder of the warranty period. You should give your proof of purchase and this Statement to that user. However, for Machines which have a life-time warranty, this warranty is not transferable.

## Warranty Service

To obtain warranty service for the Machine, you should contact your reseller or call IBM. In the United States, call IBM at 1-800-772-2227. In Canada, call IBM at 1-800-565-3344. You may be required to present proof of purchase.

IBM or your reseller will provide certain types of repair and exchange service, either at your location or at IBM's or your reseller's service center, to restore a Machine to good working order.

When a type of service involves the exchange of a Machine or part, the item IBM or your reseller replaces becomes its property and the replacement becomes yours. You represent that all removed items are genuine and unaltered. The replacement may not be new, but will be in good working order and at least functionally equivalent to the item replaced. The replacement assumes the warranty service status of the replaced item. Before IBM or your reseller exchanges a Machine or part, you agree to remove all features, parts, options, alterations, and attachments not under warranty service. You also agree to ensure that the Machine is free of any legal obligations or restrictions that prevent its exchange.

You agree to:

- obtain authorization from the owner to have IBM or your reseller service a Machine that you do not own; and where applicable, before service is provided :
- follow the problem determination, problem analysis, and service request procedures that IBM or your reseller provide,
- secure all programs, data, and funds contained in a Machine, and
- inform IBM or your reseller of changes in a Machine's location.

IBM is responsible for loss of, or damage to, your Machine while it is 1) in IBM's possession or 2) in transit in those cases where IBM is responsible for the transportation charges.

## Extent of Warranty

IBM does not warrant uninterrupted or error-free operation of a Machine.

Misuse, accident, modification, unsuitable physical or operating environment, improper maintenance by you, or failure caused by a product for which IBM is not responsible may void the warranties.

THESE WARRANTIES REPLACE ALL OTHER WARRANTIES, EXPRESS OR IMPLIED, INCLUDING, BUT NOT LIMITED TO, THE IMPLIED WARRANTIES OF MERCHANTABILITY AND FITNESS FOR A PARTICULAR PURPOSE. HOWEVER, SOME LAWS DO NOT ALLOW THE EXCLUSION OF IMPLIED WARRANTIES. IF THESE LAWS APPLY, THEN ALL EXPRESS AND IMPLIED WARRANTIES ARE LIMITED IN DURATION TO THE WARRANTY PERIOD. NO WARRANTIES APPLY AFTER THAT PERIOD.

In Canada, warranties include both warranties and conditions.

Some jurisdictions do not allow limitations on how long an implied warranty lasts, so the above limitation may not apply to you.

For European warranty terms and conditions refer to enclosed IBM warranty statement Part Number 72H9623.

Référez-vous à la garantie IBM N° de référence 72H9623 pour les conditions de garantie européennes.

Die europäischen Garantiebedingungen finden Sie in der beigefügten IBM-Gewährleistungserklärung, Teilenummer 72H9623.

Los términos y condiciones de las garantías en Europa se recogen en la declaración de garantía adjunta del número de pieza IBM 72H9623.

Per le condizioni e i termini de garanzia relativi ai paesi europei, consultare l'apposita dichiarazione IBM (numero di matricola 72H9623).

# Service Information

The following parts are for use by IBM service, or IBM authorised dealers, to support the customer warranty. Parts are for service use only.

## **T55D Flat Panel Monitor, Type 9513**

21L4360	9513-DW1	Flat Panel Monitor - 15 Digital, Pearl White
21L4361	9513-DG1	Flat Panel Monitor - 15 Digital, Slate Gray
21L4402		Power adapter
21L4404		Interface cable
21L4386		Adapter card - AGP
21L4389		Adapter card - PCI