

Note

Before using this information and the product it supports, be sure to read the general information under Appendix E, "Product Warranties and Notices" on page 255.

First Edition (March 1995)

The following paragraph does not apply to the United Kingdom or any country where such provisions are inconsistent with local law:

INTERNATIONAL BUSINESS MACHINES CORPORATION PROVIDES THIS PUBLICATION "AS IS" WITHOUT ANY WARRANTY OF ANY KIND, EITHER EXPRESS OR IMPLIED, INCLUDING, BUT NOT LIMITED TO, THE LIMITED WARRANTIES OF MERCHANTABILITY OR FITNESS FOR A PARTICULAR PURPOSE. Some states do not allow disclaimer or express or implied warranties in certain transactions, therefore, this statement may not apply to you.

This publication could include technical inaccuracies or typographical errors. Changes are periodically made to the information herein; these changes will be incorporated in new editions of the publication. IBM may make improvements or changes in the products and the programs described in this publication at any time.

It is possible that this publication may contain references to, or information about, IBM products (machines and programs), programming, or services that are not announced in your country. Such references or information must not be construed to mean that IBM intends to announce such IBM products, programming, or services in your country.

Requests for technical information about IBM products should be made to your IBM authorized dealer or your IBM marketing representative.

IBM may have patents or pending patent applications covering subject matter in this document. The furnishing of this document does not give you any license to these patents. You can send license inquiries, in writing, to the IBM Director of Licensing, IBM Corporation, 500 Columbus Avenue, Thornwood, NY 10594, U.S.A.

Copyright International Business Machines Corporation 1995. All rights reserved. Note to US Government Users – Documentation related to restricted rights – Use, duplication or disclosure is subject to restrictions set forth in GSA ADP Schedule Contract with IBM Corp.

Thank You for Selecting an IBM ThinkPad 755CX Computer

*The IBM ThinkPad 755CX
is one of the most advanced and versatile notebook computers.
With such innovative features as audio, telephony,
infrared ports, a long-life battery,
and a brilliant color display,
the ThinkPad 755CX will satisfy
all of your mobile computing needs.*



Distinctive System Features



1 **Mwave DSP audio, telephony, and fax/modem features**

The ThinkPad Mwave digital signal processor (DSP) provides high-quality audio, telephony and modem/fax functions. With a built-in speaker and a microphone, they complete your multimedia computing solution. (See page 75.)

Note: In some countries, the Mwave telephony functions are available only after the DAA/Telephony Kit option is installed.

2 **Infrared communication support**

Two infrared ports supplied with your computer make wireless serial communication possible. (See page 72.)

3 **ThinkPad Features program**

The ThinkPad Features program allows you to set various parameters either with a graphical user interface or with commands. (See page 35.)

4 **Power management**

Power management sets the computer to different modes to save battery power when you are not using the computer. It also provides a resume function, which quickly returns you to your previous operation. (See page 50.)

5 **Security features**

The computer provides security passwords for the computer and hard disk drive. Lock security and a personalization utility are also provided. (See Chapter 5.)

6 **Fn key function**

The combination of this **Fn** key and a function key controls display modes, battery power-saving modes, or other functions. (See page 48.)

7 **TFT color LCD screen**

A brilliant TFT color LCD screen supports 65 536 colors with the following display resolution for each model:

The 755CX SVGA model supports SVGA (800-by-600 resolution) video mode besides VGA (640-by-480) mode.

The 755CX VGA model supports VGA (640-by-480) mode.

8 **Easy-Setup**

The built-in system programs in Easy-Setup makes the basic setup of your computer easy. (See page 42.)

9 **TrackPoint III**

With TrackPoint III, pointing, selecting, and dragging all become part of a single process without your lifting your hands from the keyboard. (See page 23.)

1 **PCMCIA** support**

The computer provides two Personal Computer Memory Card Association (PCMCIA) slots. PCMCIA software is also provided, so that you can use PC Card** more easily and conveniently. (See page 61.)

11 **Long-life battery pack**

The operating time of the computer is extended with the long-life battery pack. (See page 20.)

About This Book

This *User's Guide* contains information that will help you operate the IBM ThinkPad 755CX computer (hereafter called *755CX* or *computer*).

Chapter 1, "Getting Started," describes the Product Map and explains how to set up your computer.

Chapter 2, "Getting Familiar with Your Computer," acquaints you with additional features of your computer.

Chapter 3, "Operating Your Computer," explains how to use the various features of your computer.

Chapter 4, "Using Battery Power," provides battery information and describes how to operate your computer with the battery pack.

Chapter 5, "Protecting Your Computer," provides information on how you can secure your computer and internal devices against unauthorized use.

Chapter 6, "Installing and Removing Options," describes how to install or remove IBM options.

Chapter 7, "Installing Software," explains how to install operating systems, device drivers, and other support software.

Chapter 8, "Solving Computer Problems," describes what to do if you detect a problem.

Appendix A, "Avoiding Hardware Conflicts," describes how you can avoid problems when you add or remove options.

Appendix B, "Advanced Information for PC Cards," provides advanced technical information when using PC Cards.

Appendix C, "Additional Information for Mwave DSP Features," provides technical information about the ThinkPad Mwave DSP functions, audio, and telephony.

Appendix D, "Features and Specifications," describes the features and specifications associated with your computer.

Appendix E, "Product Warranties and Notices," contains the warranty statements of your computer and notices for this book.

"Glossary," includes terms appearing in this *User's Guide* and their definitions.

Information Notices

This *User's Guide* contains notices that relate to specific information or text.

Note:

Provides important hints, tips, guidance, or advice.

Warning:

Indicates possible damage to programs, devices, system, or data. It appears before the related instruction or situation in which possible damage could occur.

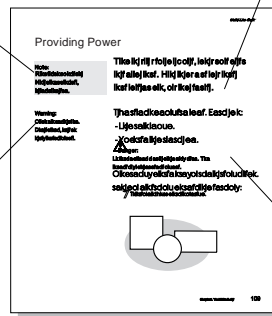

Caution:

Indicates situations that are potentially hazardous to you. It appears in text before the instruction or situation that could be hazardous.

Danger:

Indicates situations that are potentially lethal or extremely hazardous to you. It is indicated by the

symbol  and appears in text before the instruction or situation that could be dangerous.

Treatment of Icons

This *User's Guide* contains the following icons (symbols) representing procedures or information unique to the operating system installed in your computer, or pointing you to other information.



Information for IBM Operating System/2 (OS/2) users.



Information for DOS users.



Information for Microsoft** Windows** users.



Where to go for other information.

Electrical Safety Notice



DANGER:

Electrical current from power, telephone, and communication cable is hazardous. To avoid shock hazard, connect and disconnect cables as shown below when installing, moving, or opening the covers of this product or attached the devices. The power cord must be used with a properly grounded outlet.

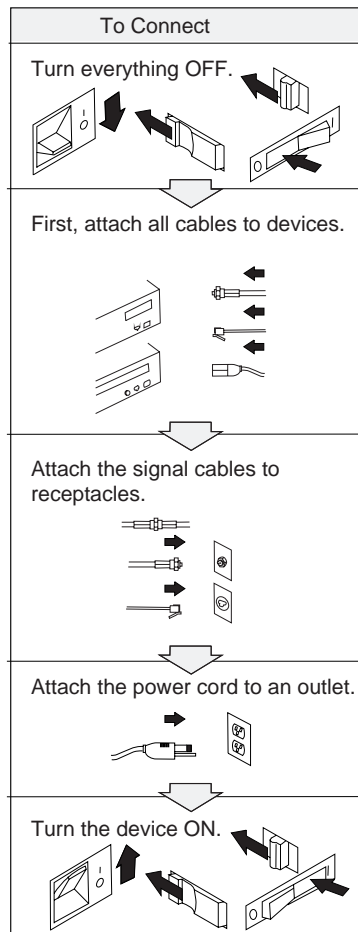

Note: In the U.K., by law, the telephone line cable must be connected after the power cord.

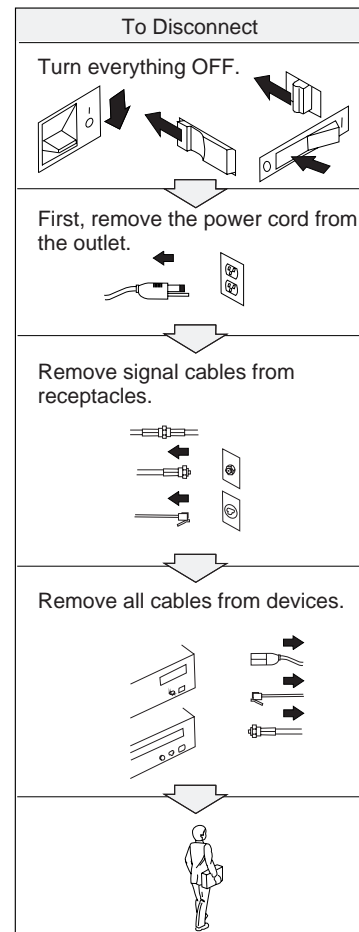

Note: In the U.K., by law, the power cord must be disconnected after the telephone line cable.

CAUTION:

Do not disassemble, incinerate, or short-circuit the rechargeable battery pack. Do not put it in refuse that is disposed of in landfills. Dispose of it as required by local ordinances or regulations.

CAUTION:

The lithium battery (IBM P/N 84G6426, UL** recognized component—File No. MH12210), attached by the speaker under the keyboard can be replaced only by your IBM authorized reseller or IBM marketing representative. It contains lithium and can explode if not properly used, handled, or disposed of. Do not: (1) throw or immerse into water, (2) heat to more than 100°C (212°F), or (3) repair or disassemble. Dispose of it as required by local ordinances or regulations.

CAUTION:

The nickel metal hydride rechargeable battery attached under the diskette drive, can be replaced only by your IBM authorized reseller or IBM marketing representative. Do not disassemble, incinerate, or short-circuit it. The battery can cause burns or release toxic chemicals. Do not put it in refuse that is disposed of in landfills. Dispose of it as required by local ordinances and regulations.

CAUTION:

The fluorescent lamp in the liquid crystal display (LCD) contains mercury. Do not put it in refuse that is disposed of in landfills. Dispose of it as required by local ordinances or regulations.

The LCD is made of glass, and rough handling or dropping the computer can cause the LCD to break. If the LCD breaks and the internal fluid gets into your eyes or on your hands, immediately wash the affected areas with water for at least 15 minutes; then get medical care if any symptoms are present after washing.

Contents

About This Book	vii
Information Notices	viii
Treatment of Icons	viii
Electrical Safety Notice	ix
Chapter 1. Getting Started	1
About the Product Map	2
Checking Your Items	2
Other Symbols on the Product Map	4
Setting Up Your Computer	6
Chapter 2. Getting Familiar with Your Computer	11
Locations and Functions	12
System-Status Indicators	16
Providing Power	18
AC Adapter	18
Battery Pack	20
Car Battery Adapter	22
Operating with the TrackPoint III	23
Changing the Cap	25
Operating the Numeric Keypad	26
Using the Display	27
Using a DOS Application with Your 755CX SVGA Model ..	28
Using the Online Book	29
Starting for OS/2 or Windows	29
Starting for DOS	29
Keeping the Computer from Being Damaged	30
Carrying the Computer	31
Chapter 3. Operating Your Computer	33
What Happens When Power Is Turned On?	34
Using the ThinkPad Features Program	35
Using the Program for OS/2 and Windows	36
Using the PS2 Program	41
Using Easy-Setup	42
Starting Easy-Setup	42
Using the Selectable Drive-Startup Sequence	47
Using the Fn Key Function	48
Using Power Management	50
Standby Mode	52
Suspend Mode	53
Hibernation Mode	57
Using PC Cards	61
About PC Cards	61
Limitations of Operation during Suspend and Hibernation Modes	61

Using the PC Card Director Program	62
Using the Infrared Communication Feature	72
Considerations for Communication	74
Using the Mwave DSP Features	75
Using the Audio Function	78
Using the Telephony Function	84
Chapter 4. Using Battery Power	91
Operating Time with the Battery Pack	92
Charging the Battery Pack	92
Charging with the AC Adapter	93
Charging with the Travel Quick Charger	94
Replacing the Battery Pack	95
Monitoring the Battery-Power Status	96
Using the Battery-Power Status Indicator	96
Using the Fuel-Gauge Program	98
Preserving Battery-Pack Life	103
Maximizing Battery-Powered Operation	104
Using Advanced Power Management	104
Decreasing LCD Brightness	105
Using Power-Saving Modes	106
Chapter 5. Protecting Your Computer	109
Using Passwords	110
Power-On Password	110
Hard-Disk Password	114
Supervisor Password	118
Using the Hard-Disk and Power-On Passwords	122
Using the Supervisor and Hard-Disk Passwords	122
Using Several Hard Disk Drives with the Supervisor Password	123
Using the Personalization Utility Program	125
Using Locks	130
Using the Lock on the Hard Disk Drive	130
Using the Security Lock	131
Using the PC Card Lock	132
Chapter 6. Installing and Removing Options	133
Installing and Removing PC Cards	134
Inserting the PC Card	134
Removing the PC Card	136
Increasing Memory Capacity	137
Installing an IC DRAM Card and DIMM	138
Removing the IC DRAM Card and DIMM	143
Replacing the Hard Disk Drive	148
Installing Options in the Diskette Drive Compartment	150

Reinstalling the Option Cover and Front Bezel	153
Installing the DAA/Telephony Kit	155
Attaching an External Numeric Keypad or a Mouse	159
Using the Mouse and Other Pointing Devices	160
Using a Mouse on the IBM ThinkPad Space Saver Keyboard	161
Attaching an External Keyboard	163
Attaching a Printer	164
Attaching an External Display	165
Changing the Display Mode	166
Setting the Monitor Type and the Display Driver	167
Connecting the External Display to the Computer	169
Changing the Screen Resolution or Color Depth	170
Using SVGA Display Drivers	171
Attaching the IBM Dock I or Dock II	172
Chapter 7. Installing Software	173
What You Need for Your Computer	174
Installing the Operating System	176
IBM OS/2 Warp or Version 2.11	176
IBM DOS Version 7.0 or Later	176
Microsoft Windows Version 3.11 or Later	177
Installing the ThinkPad Features Program	180
Installing for OS/2	180
Installing for DOS	181
Installing for Windows	182
Installing the PCMCIA Device Driver	183
Installing for OS/2	185
Installing for DOS	186
Installing for Windows	187
Installing the ThinkPad Display Driver	188
Installing for OS/2 Warp	189
Installing for OS/2 V.2.11	189
Installing for Windows	191
Installing the Mwave Support Software	192
Installing for OS/2	192
Installing for DOS	194
Installing for Windows	195
Installing the Infrared Device Driver	196
Installing for OS/2	196
Installing for Windows	197
Chapter 8. Solving Computer Problems	199
Commonly Asked Problems and Actions	200
Testing the Computer	202
Troubleshooting Charts	204
LCD Problems	204

Screen Messages	206
Error Codes	208
General Problems	210
What If Testing Cannot Find the Problem?	211
Battery Power Problems	211
Diskette Drive Problems	213
Mwave DSP Feature Problems	213
Infrared Communication Problems	214
Software Problems	215
Option Problems	215
Keyboard, External Numeric Keypad, and Pointing Device Problems	216
External Display Problems	218
Printer Problems	220
Intermittent Problems	220
Listing Installed Options	221
Recording Identification Numbers	222
Getting Service	223
The IBM HelpClub: Another Great Choice (for European Countries)	224
Appendix A. Avoiding Hardware Conflicts	227
Appendix B. Advanced Information for PC Cards	231
Auto Configurator for the PC Card Director Program	231
Example When a Modem Card Is Used	232
Example When the Auto Configurator Is Not Used	232
Example of the Memory Area for the Card Services and 3270	233
Operational Considerations for PCMCIA	234
Software Considerations for OS/2	234
Software Considerations for DOS	235
Software Considerations for Windows	242
Appendix C. Additional Information for Mwave DSP Features	243
Audio Information	243
Sound	243
Mwave MIDI Overview	244
Telephony Information	247
Appendix D. Features and Specifications	249
Features	249
Specifications	251
IBM Power Cords	252
Diskette Standards	254

Appendix E. Product Warranties and Notices	255
Notices	261
Trademarks	261
Electronic Emission Notice	263
Glossary	269
Index	273

Chapter 1. Getting Started

Welcome to the world of ThinkPad computers!

The IBM ThinkPad 755CX is one of the most advanced computers for your mobile computing needs. It can be used both inside and outside your office.

This chapter describes the *Product Map* and the steps for setting up the computer.

About the Product Map	2
Checking Your Items	2
Other Symbols on the Product Map	4
Setting Up Your Computer	6

Getting Started

About the Product Map

The Product Map is a foldout diagram that you will see first when you unpack the computer. Using the Map will help you become familiar with your computer. When you physically place the shipping items and options on the Map, you will be able to check that all items were shipped to you.

Checking Your Items

Remove the Product Map from the box and spread it on a desk or flat surface. Next, remove each item and place it on the Map in the position indicated by the numbers in the following figure. If any item is missing or damaged, contact your place of purchase.

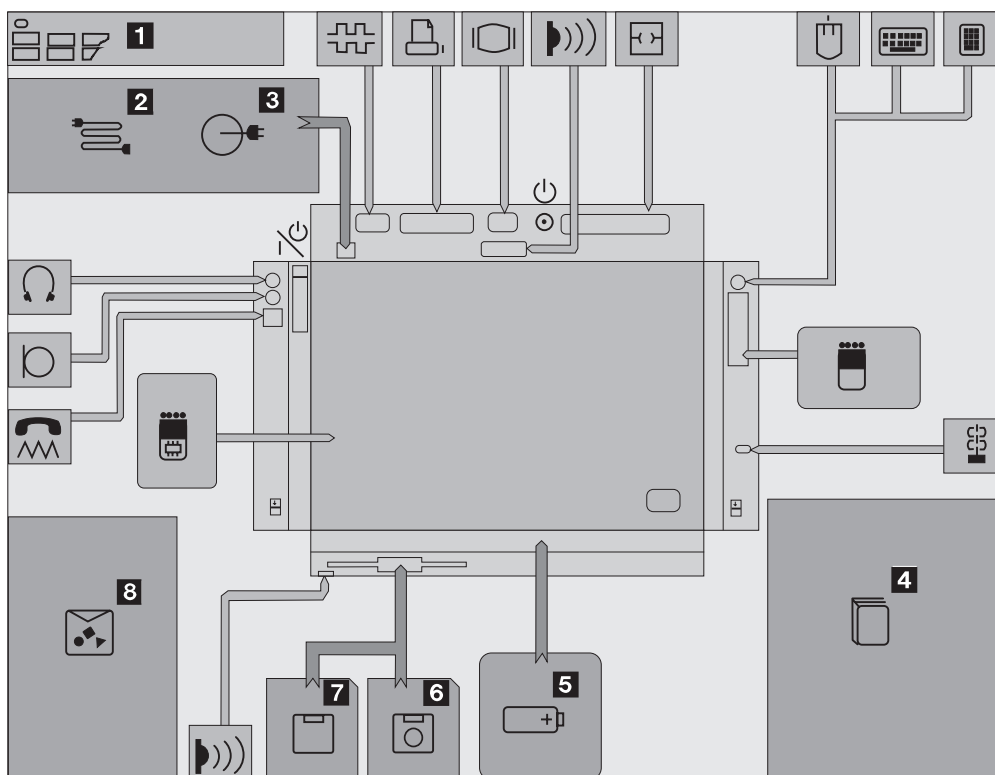



1 The **keyboard template** shows function-key assignments when placed on the keyboard.

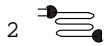

2 The **power cord** connects the AC Adapter to the electrical outlet.



3 The **AC Adapter** plugs into an electrical outlet and supplies power to the computer.



4 The **User's Guide** is this book. It provides the installing and operating information about your computer.



5 The **battery pack** supplies power to the computer for mobile operation.



6 The **Utility Diskette** contains the various system programs.



7 The **PCMCIA Features Diskette** contains the programs for the PCMCIA function.

The **Video Features Diskette for OS/2 and Video Features Diskette for Windows** contain the video system programs for the different operating systems.

The **Infrared Features Diskette** contains the infrared communication support programs.

The **Mwave DSP Features Diskettes** contain the DSP (digital signal processor) support programs.



8 **Miscellaneous items** are supplied in an envelope that contains:

- Spare caps for TrackPoint III
- Wallet for telephone cable
- PCMCIA slot cover with cable opening
- PC Card lock
- Adhesive strap
- Application envelope (for some countries)
- Other items

† For some countries, the shipment contains *no* diskettes.

Therefore, you cannot place items on the diskette icons when checking the items shipped with your computer.

You can either create the diskettes yourself or you can purchase them. You can create diskettes with the Diskette Factory program, which is preinstalled in your computer. Follow the prompts that appear when the computer is turned on for the first time. You can also purchase the diskettes; call 1-800-772-2227 for purchasing information in the U.S., or contact your IBM authorized reseller or IBM marketing representative. Follow the instructions on "Building System Diskettes" in the *Preload Guide*.

Other Symbols on the Product Map

This section describes the slots, connectors, and options that are shown on the Product Map. To install options, refer to Chapter 6.

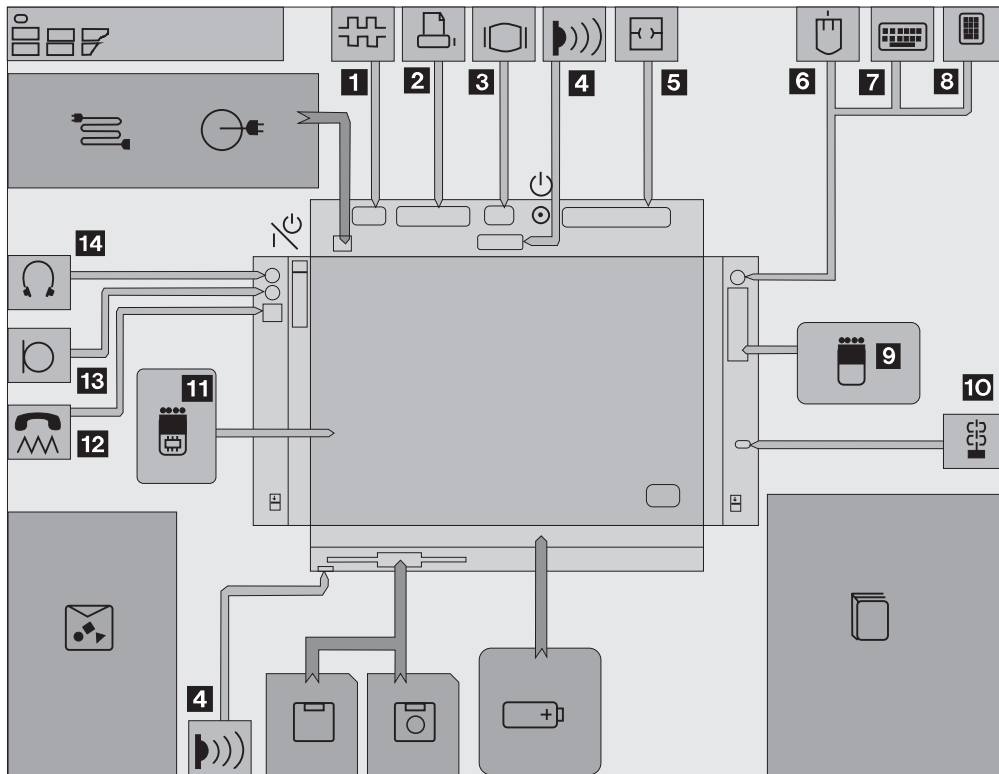



The **serial connector** is where you connect a 9-pin, serial-device cable.



The **parallel connector** is where you usually connect a parallel-printer signal cable.



The **external-display connector** is where you connect the signal cable of a video graphics adapter (VGA), super video graphics adapter (SVGA), or compatible display.



The **infrared ports** are used to make point-to-point communication with other devices with an infrared port.



The **system expansion connector** is used to connect the Dock I, Dock II, or Port Replicator option.



The **mouse** connects directly to the external input-device connector or is used with the external numeric keypad.



The **external keyboard** connects to the external input-device connector through the keyboard/mouse connector.



The **external numeric keypad** connects to the external input-device connector.



The **PCMCIA slots** accept one or two cards based on Personal Computer Memory Card International Association (PCMCIA).



The **security keyhole** is used with the Kensington** MicroSaver** Security System (hereafter called *Kensington lock*) or a compatible lock to protect the devices inside of the computer.



The **memory slot**, which is under the removable diskette drive, accepts an integrated-circuit dynamic random-access memory (IC DRAM) card or a dual inline memory module (DIMM) adapter with one or two DIMM memory options.



The **modem/fax port** is where you connect a telephone connector or attachment.

Note: This is offered as an option in some countries.



The **microphone/line-in jack**, a 1/8-inch (3.5-mm) diameter jack, is where a stereo microphone or external audio device is connected. An externally powered dynamic microphone or condenser microphone, or an equivalent audio device, can be used.



The **headphone jack**, a 1/8-inch (3.5-mm) diameter jack, is where you connect a stereo headphone or external speakers.

Warning:
To avoid possible loss of hearing, do not put on the headphones until after you have turned on the computer or connected the headphones to this jack.

Setting Up Your Computer

You are now ready to assemble and start your computer. The following steps will guide you through the process.

The following conventions are used in the illustrations appearing in this chapter:

- 1** Indicates a main sequence of actions.
- ① Indicates a subsequence of actions in a main action. An arrow accompanying the number shows the direction of movement.

1 Slide the latches on the sides of the computer halfway toward the front; then open the liquid crystal display (LCD).

2 Slide the same two latches forward again all the way toward the front; then raise the keyboard.

Some pressure might be needed to slide these latches if they are tight.

3 Install the battery pack into the middle compartment and firmly press it in to make sure of the electrical connection; then close the keyboard.

Sliding the latches forward while closing the keyboard makes it easier to close the keyboard.

CAUTION:

The battery pack provided with your computer contains a small amount of harmful substances. To avoid possible injury:

Do not touch the battery terminals to any metal objects.

Keep the battery pack away from fire.

Do not soak the battery pack in water or expose it to rain.

Do not attempt to disassemble the battery pack.

Avoid mechanical shocks to the battery.

Always use battery packs recommended by IBM.

Keep the battery pack away from children.

Right Side View

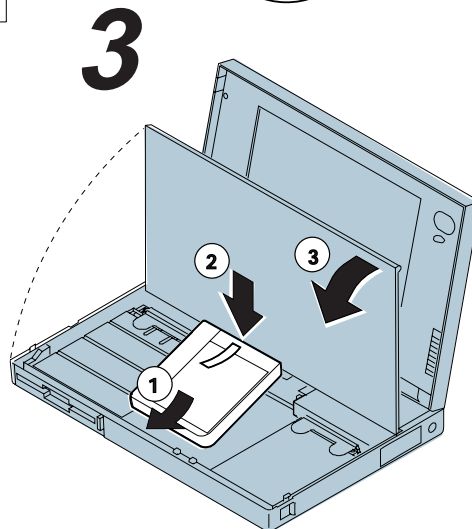
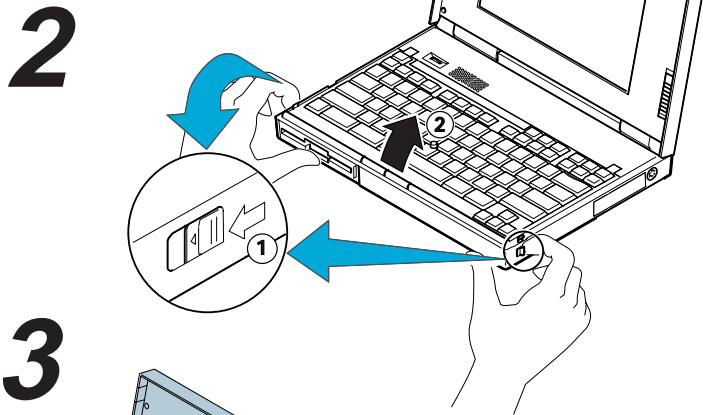
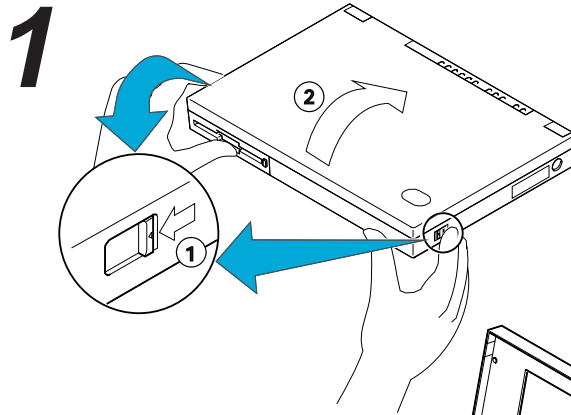
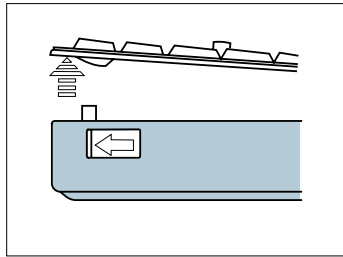
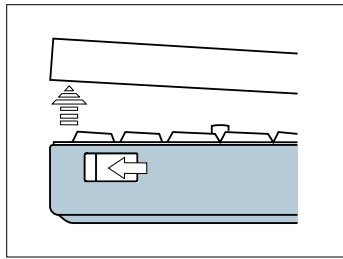

Getting Started

- 4** Connect the AC Adapter as shown.
- 5** Position the speaker volume control to “3.”
- 6** Push and release the power switch to turn on the computer.
The power switch automatically returns to its original position after you push and release it.
- 7** Position the LCD so that it is convenient for viewing;
then position the brightness (☀) as shown.
- 8** After a single beep, one of the following screens appears, confirming that the system is operating correctly.

(In some countries, the demonstration program runs automatically and its associated screen appears.) If any other screen appears, see “Screen Messages” on page 206.

An Operating System screen

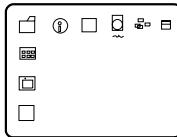

Date and Time menu

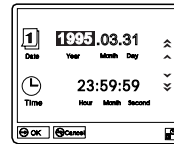

If you purchased a computer with a preinstalled operating system, the startup screen of the operating system appears. (The screen shown is an example of an operating system screen.)

 Install your application programs by following the instructions in the documentation that came with the programs.

This screen instructs you to set the initial date and time.

Note: For the 755CX SVGA model, the screen image might look smaller than this sample.

 To set the date and time, see “Using Easy-Setup” on page 42.

Congratulations!

You have successfully completed the basic setup of your computer!

Getting Started

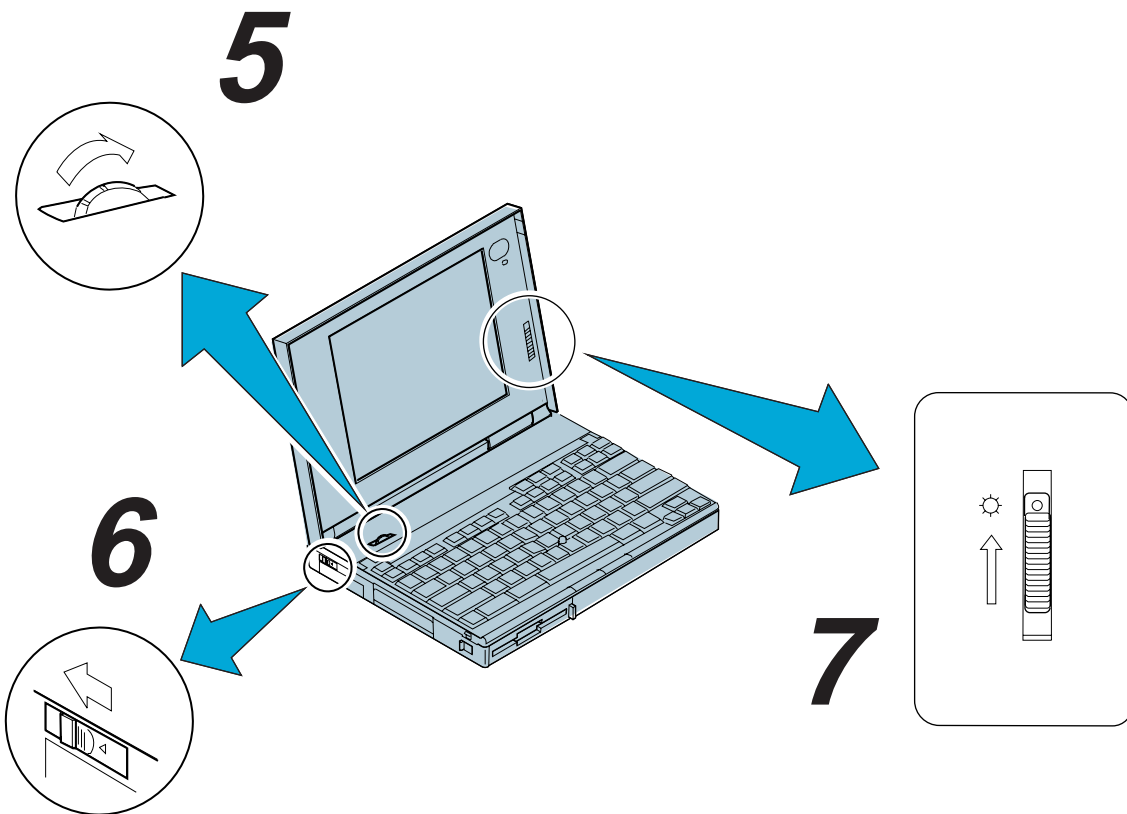
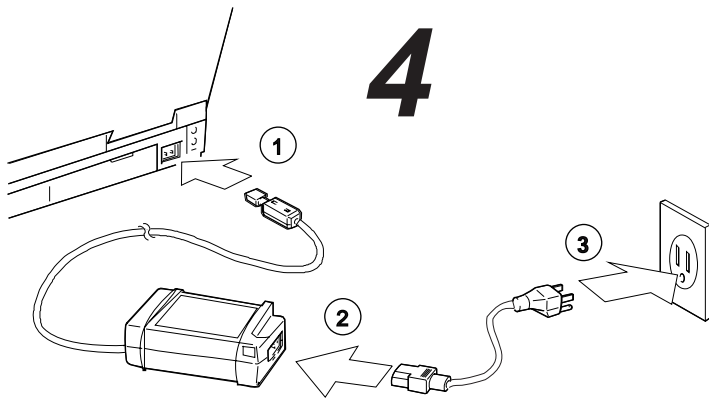

Getting Started

Chapter 2. Getting Familiar with Your Computer

This chapter provides general information about your computer.

Locations and Functions	12
System-Status Indicators	16
Providing Power	18
AC Adapter	18
Battery Pack	20
Car Battery Adapter	22
Operating with the TrackPoint III	23
Changing the Cap	25
Operating the Numeric Keypad	26
Using the Display	27
Using a DOS Application with Your 755CX SVGA Model	28
Using the Online Book	29
Starting for OS/2 or Windows	29
Starting for DOS	29
Keeping the Computer from Being Damaged	30
Carrying the Computer	31

Locations and Functions

Locations and Functions

This section provides additional useful information about your computer.

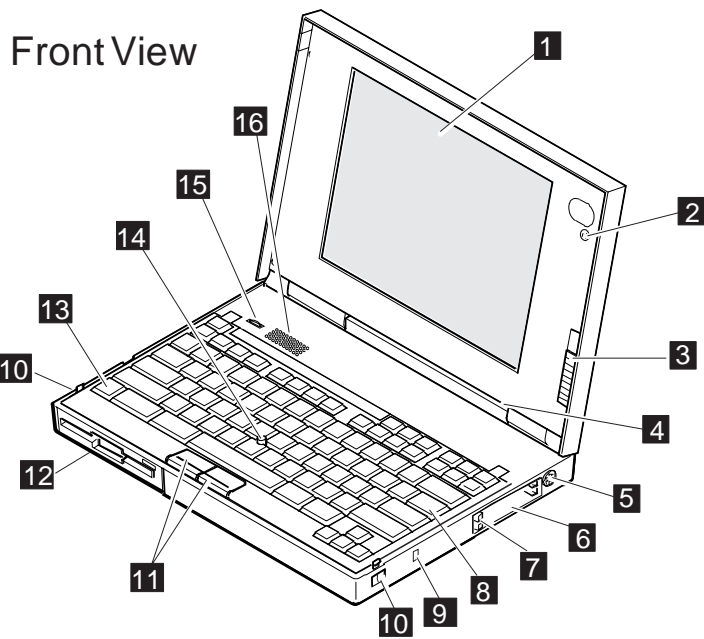

Locations and Functions

- 1 The **color LCD screen**, which uses a thin film transistor (TFT) technology, displays the computer output and can be moved to any desired viewing angle.
 - 755CX SVGA model supports SVGA (800-by-600 resolution) video mode besides VGA (640-by-480) with 65 536 colors.
 - 755CX VGA model supports only VGA mode with 65 536 colors.

A 1024-by-768 resolution video at maximum can be produced on any attached external display that supports the resolution mode. (See page 165.)
- 2 The **built-in microphone** captures sound and voice when it is used with an application program capable of handling an audio or telephony function. (See page 75.)
- 3 The **brightness control** moves up or down to adjust the brightness of the display.
- 4 The **indicator panel** consists of the system-status indicators and their associated symbols. These indicators show the current status of the computer. (See page 16.)
- 5 The **external input-device connector** is used to attach a mouse, external keyboard, or external numeric keypad to the computer. (See page 159–163.)
- 6 **PCMCIA slots** accept one or two PC Cards. (See page 134.)
- 7 The **PC Card eject buttons** eject the PC Card from the upper or lower PCMCIA slot.
- 8 The **keyboard** is used to enter data into the computer. To use the numeric keypad, see 26.
- 9 The **security keyhole** is used with a Kensington lock or a compatible lock to protect your computer. (See page 131.)
- 1 The **release latches** release the LCD or keyboard so they can be opened.
- 11 The **click buttons** are used with the TrackPoint III.
- 12 The **front infrared port** allows the computer to communicate with other devices that have the same capability. (See page 72.)
- 13 The **Fn key** is used to activate the **Fn** key functions. (See page 48.)
- 14 **TrackPoint III** is a built-in pointing device that provides a function similar to that of a mouse. (See page 23.)
- 15 The **volume control** adjusts the sound level for the built-in speaker.
- 16 The **built-in speaker** reproduces computer sounds such as beeps, music, or voices. (See page 75.)

Locations and Functions

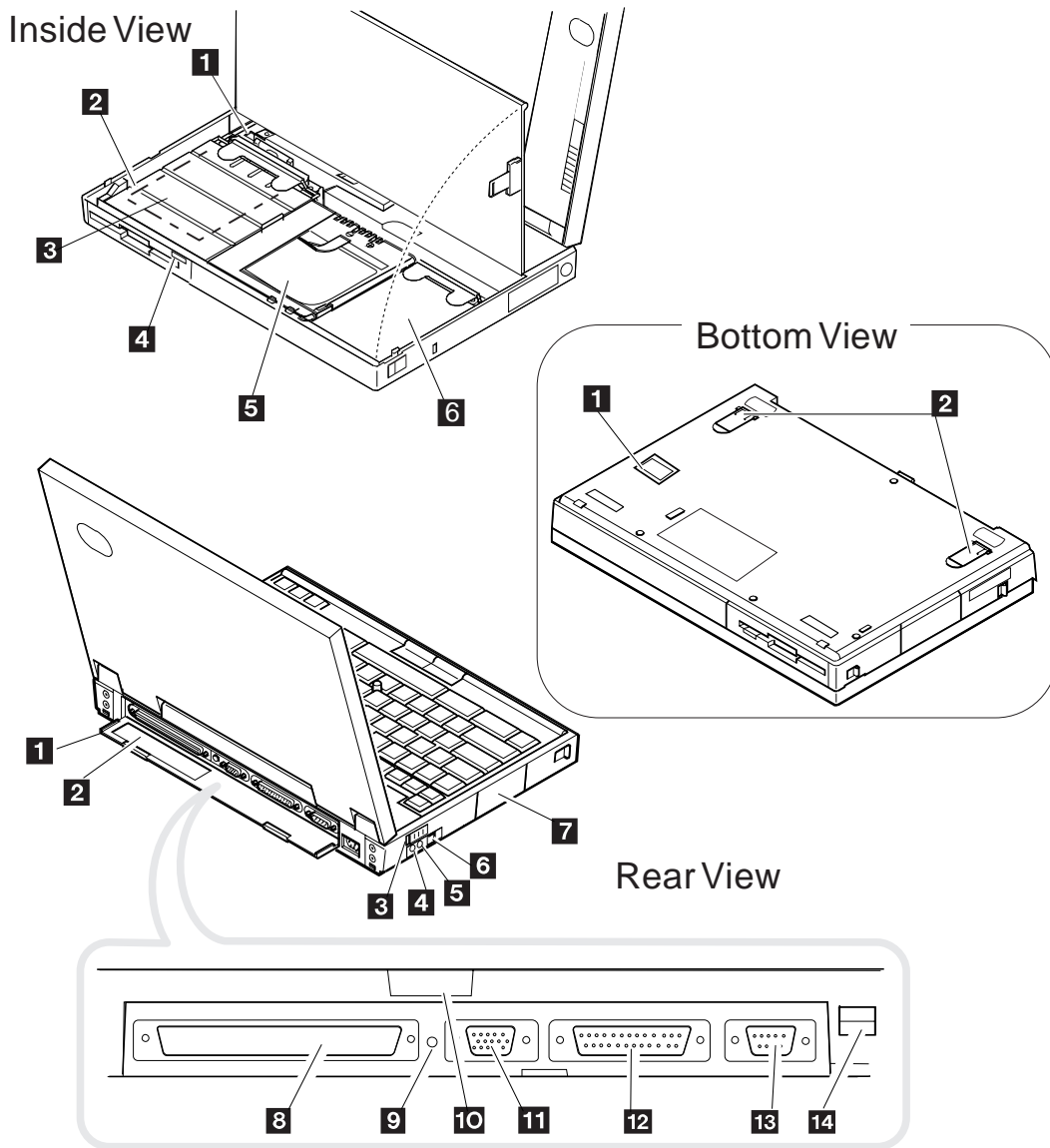

Locations and Functions

Inside View

- 1 The **modem/fax port release latch** releases the modem/fax port from the computer. (See page 155.)
- 2 The **removable diskette drive** reads data from or writes data to a diskette. One 3.5-inch, 1.44MB or 2.88MB diskette drive can be installed.

The 2.88MB drive supports the following diskettes (the formatted capacities are shown in parentheses): 1MB (720KB), 1.6MB (1.2MB), 2MB (1.44MB), or 4MB (2.88MB).

The 1.44MB drive supports the following diskettes: 1MB (720KB) or 2MB (1.44MB).

(For installing options in the diskette drive compartment: see page 150.)
- 3 The **memory slot**, which is under the removable diskette drive, accepts an IC DRAM card or a dual inline memory module (DIMM) adapter with one or two DIMM memory options. (See page 137.)
- 4 The **diskette-eject button** ejects a diskette from the diskette drive.
- 5 The **battery pack** allows you to operate the computer when ac power is not available. (See page 20.)
- 6 The **removable hard disk drive** can be replaced with one with a different capacity. (See page 148.)

Rear View

- 1 The **rear door** covers the connectors at the rear of the computer.
- 2 The **connector door** allows the connection of a cable to the system-expansion connector when the rear door is closed.
- 3 The **power switch** turns the computer on and off.
- 4 The **headphone jack**, a 1/8-inch (3.5-mm) diameter jack, is where you connect a stereo headphone or external speakers. (See page 76.)
- 5 The **microphone/line-in jack**, a 1/8-inch (3.5-mm) diameter jack, is where a stereo microphone or external audio device is connected. (See page 76.)
- 6 The **modem/fax port** is where you connect a telephone connector or attachment. This is offered as an option in some countries. (For using: see page 76. For installing: see page 155.)
- 7 The **option cover** can be removed when options are used in the diskette-drive compartment. (See page 153.)
- 8 The **system-expansion connector** is used to connect the IBM Dock I, Dock II, or Port Replicator. (See page 172.)

- 9 The **power shutdown switch** is used to turn the computer off when the application locks up or the computer will not accept any input. Use the tip of a pen to press this switch.
- 1 The **rear infrared port** (See "Front Infrared Port" on page 13.)
- 11 The **external-display connector** is where you connect the signal cable of a video graphics adapter (VGA), super video graphics adapter (SVGA), or compatible display. (See page 165.)
- 12 The **parallel connector** is where you usually connect a parallel-printer signal cable. (See page 164.)
- 13 The **serial connector** is where you connect a 9-pin, serial-device cable.
- 14 The **power jack** is where the AC Adapter cable is connected.

Bottom View

- 1 The **locking lever** is used with a chain to lock and prevent the keyboard from being opened. It secures the internal devices under the keyboard. (See page 130.)
- 2 The **legs** are used to adjust the keyboard angle.





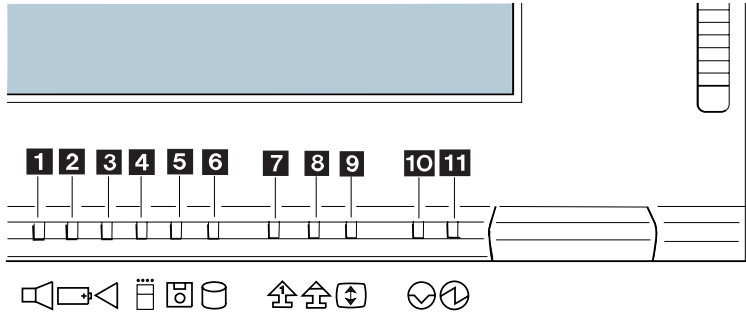

System-Status Indicators

System-Status Indicators





The system-status indicators show the current status of your computer by their on or off states or by their colors (green, yellow, and orange). Each indicator is identified by a symbol.

The following figure and table show the location of each symbol and the meaning of each indicator:



Symbol	Color	Meaning
1 Speaker 	Blinking green	When enabled by the ThinkPad Features program, this indicator blinks when the speaker sounds. It turns off when any key is pressed. (To enable this indicator, see "Using the ThinkPad Features Program" on page 35.)
2 Battery power status 	Green	Shows the condition of the battery pack. Green or yellow Enough power remains for operation. Orange Some power remains for operation. Blinking orange The battery pack needs charging.
	Yellow	
	Orange	
	Blinking orange	
3 Battery charging 	Green	Indicates that the battery pack is being charged.
	Blinking green	Indicates that the battery pack is being discharged before being charged.
4 PC card active 	Orange	Turns on when power is supplied to the PCMCIA slot. Refer to the PC Card manual to see if the PC Card can be removed without turning the computer off.
5 Diskette drive in use 	Orange	Turns on when data is read from or written to a diskette. Do not enter suspend mode or eject the diskette when this indicator is on.
6 Hard disk in use 	Orange	Turns on when data is read from or written to the hard disk. Do not enter suspend mode or turn off the computer when this indicator is on.

System-Status Indicators

Symbol	Color	Meaning
7 Numeric lock 	Green	Indicates that the numeric keypad on the keyboard is enabled. The keypad is enabled and disabled by pressing and holding the Shift key, and pressing the NumLk key. For more information about the numeric keypad, see “Operating the Numeric Keypad” on page 26.
8 Caps lock 	Green	Indicates that the Caps Lock mode is enabled. All alphabetic characters (A-Z) are entered in capital letters without the use of the Shift key. The Caps Lock mode is enabled and disabled by pressing the Caps Lock key.
9 Scroll lock 	Green	Alternately turns on and off each time the ScrLk key is pressed. While this indicator is on, the Arrow keys are used as screen-scroll function keys. In this state, the cursor cannot be moved with the Arrow keys. Not all application programs support this function.
1 Suspend mode 	Green	Indicates that the computer is in suspend mode. See page 50 for more information about suspend mode.
	Blinking green	Indicates that the computer is entering suspend or hibernation mode, or is resuming normal operation.
11 Power on 	Green	Indicates that the computer is operational. This indicator is on when the computer is on and not in suspend mode.

Providing Power

Providing Power

Your computer can be operated with the AC Adapter, battery pack, or Car Battery Adapter (available as an option).

AC Adapter

Note:

When the AC Adapter is connected, and the remaining power of the installed battery pack is less than a certain amount, discharging and then charging of the battery pack starts automatically.

The AC Adapter is an alternating-current-to-direct-current (ac-to-dc) converter that supplies power for the computer. The AC Adapter also charges the battery pack when the battery pack is installed in the computer. The input rating for the AC Adapter is 100–240 V ac, 50/60 Hz.

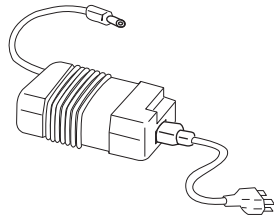

CAUTION:

Do not attempt to open the AC Adapter case. The AC Adapter is permanently sealed and cannot be repaired.

If you turn on the computer when the battery pack is installed, you will hear a short beep when you connect or disconnect the AC Adapter from the computer. This short beep means that the power source has been changed.

When the AC Adapter cable is disconnected from the computer with a battery pack installed, the LCD brightness decreases slightly to conserve battery power.

Warning:

Always use the AC Adapter certified by IBM in the country where you will be using the computer. Operating the computer with an incorrect AC Adapter can cause damage to the battery pack and to the computer.

Providing Power

To Wrap and Fasten the AC Adapter Cable

When you carry the AC Adapter with your computer, you can wrap and fasten the cable as follows:

①

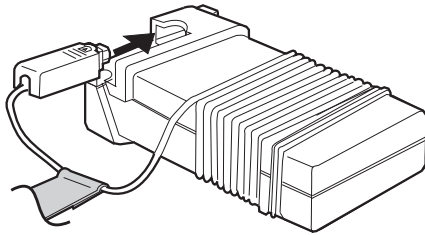

②

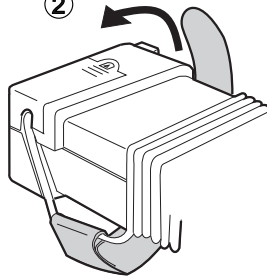

③

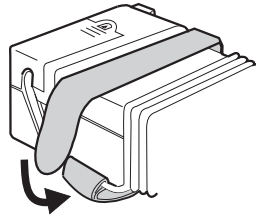

Providing Power

Battery Pack

The battery pack is an internal power source for the computer when the AC Adapter is not available. The battery pack can be recharged with the AC Adapter or the battery charger (available as an option).

Battery packs are shipped from the factory in an almost discharged state, so you *must charge* them before use.

To operate your computer with the battery pack, see Chapter 4.

You can use the following battery packs for the ThinkPad 755CX.

Lithium Ion Battery Pack

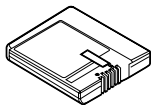

The following table shows the operating time of the computer with a fully charged lithium ion battery pack:

Model	Battery Operating Time
755CX SVGA model	3.0 — 9.0 hours *
755CX VGA model	3.2 — 10.0 hours *

Note:

* The operating time depends on the options used with the computer, the frequency of key input, applications, and the configuration of the system, so it might be shorter or longer than the following time.

Nickel Metal Hydride Battery Pack

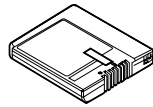

The following table shows the operating time of the computer with a fully charged nickel metal hydride battery pack (hereafter called *NiMH battery pack*):

Note:

* The operating time depends on the options used with the computer, the frequency of key input, applications, and the configuration of the system, so it might be shorter or longer than the following time.

Model	Battery Operating Time
755CX SVGA model	2.4 — 7.0 hours *
755CX VGA model	2.6 — 8.0 hours *

Before Using the NiMH Battery Pack

This battery pack has an internal microprocessor to send the battery status to the computer. The *storage switch* 1 on the battery pack sets this microprocessor on or off. When you use this battery pack for the first time, set the switch to the on (|) position.

Do not slide the storage switch to the off position (O) after you set it to the on position at the time of purchase. If you set this switch to the off position by mistake, slide the switch to the on position (|); then discharge and recharge it to make sure the microprocessor sends the correct status of the battery to the computer.

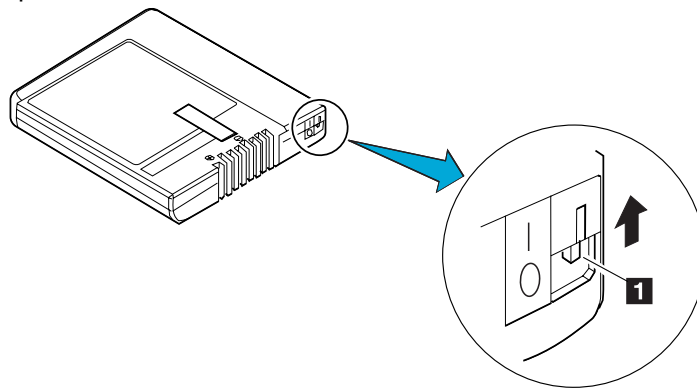

Providing Power

For Your Information

Standby Battery: Your computer has another rechargeable battery, called the *standby battery*. It supplies the necessary power to save data when a battery pack is replaced during suspend mode. The standby battery can be replaced only by your IBM authorized reseller or IBM marketing representative. To charge the standby battery, connect the AC Adapter to the computer. When using the computer for the first time, let the battery charge for at least 8 hours to allow it to become fully charged.

Car Battery Adapter

The Car Battery Adapter, available as an option, plugs into the cigarette lighter socket of a car and supplies power to your computer.

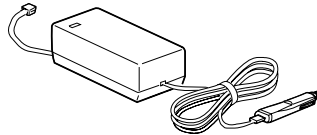

See the manual supplied with the Car Battery Adapter for more information.

Operating with the TrackPoint III

Note:

No other software is required for the TrackPoint III; it works with the PS/2 mouse driver.

The keyboard contains a unique cursor-pointing device called the *TrackPoint III*. Pointing, selecting, and dragging all become part of a single process, without moving your fingers from their typing position.

The TrackPoint III consists of a stick **1** on the keyboard and a pair of click buttons **2** below the keyboard. The motion of the cursor on the screen is controlled by the amount of pressure applied to the nonslip cap stick in any direction parallel to the keyboard; the stick does *not* move. The speed at which the cursor moves corresponds to the amount of pressure on the stick. The function of the click buttons depends on the software that is used.

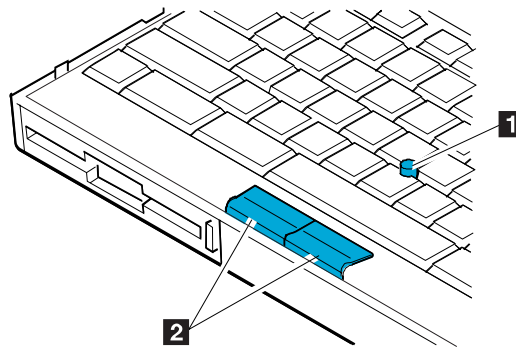

Using the TrackPoint III

If you are not familiar with the TrackPoint III, these instructions will help you get started:

Note:

Remember that the stick does not move, and your finger should not move on it.

Note:

The mouse cursor may drift in some computer conditions. It is not a defect. Do not use the TrackPoint III until the pointer stops moving.

- 1** Place your hands in the typing position and press gently on the stick with either index finger in the direction in which you want the cursor to move.

Pressing the stick away from you moves the cursor up the screen; pressing it toward you moves the cursor down the screen. You can also move the cursor side to side by pressing sideways.

- 2** Press the click buttons with either thumb to select and drag as required by your software, as with any other pointing device.

Hints and Tips

You can easily drag an item across the screen without constantly pressing the click buttons of the TrackPoint III. To drag and drop an object, press the click button and slide it toward the front of the computer. The click button locks in place; you can now drag the object across the screen with the TrackPoint III stick without holding down the click button.

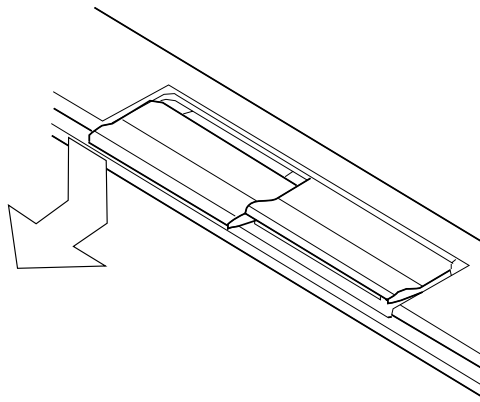

To release the latch, press it from the front side of the click button.

Changing the Cap

The cap 1 on the end of the TrackPoint III is removable. You can replace it with one of the spares shipped with your computer.

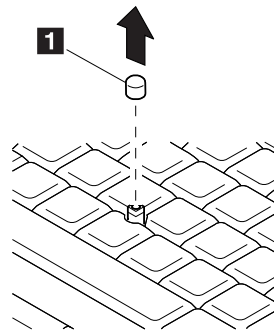

Operating the Numeric Keypad

Operating the Numeric Keypad

The keyboard has some keys that, when enabled, work as if they were a 10-key numeric keypad. (The numeric keypad on the keyboard is not active when the external numeric keypad is attached to the computer.)

To enable the numeric keypad, press and hold **Shift** and then press **NumLk**.

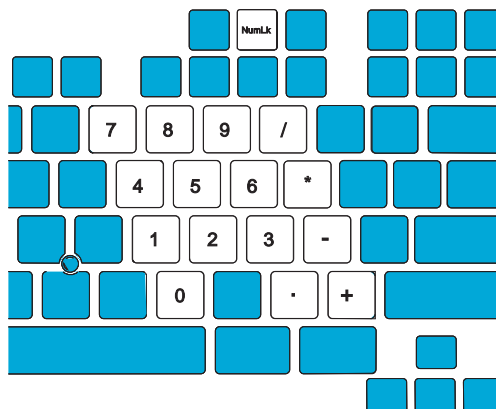

Note:
The keys are functional, but the function of the key is not printed on the keytop.

When the keypad is enabled, press and hold **Shift** to temporarily use the cursor- and screen-control keys.

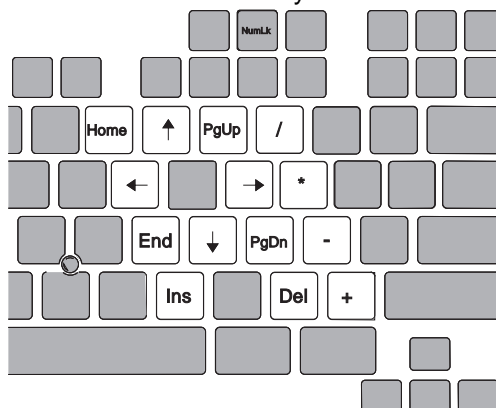

To disable the numeric keypad, press and hold **Shift**; then press **NumLk** again.

Using the Display

The LCD of your computer supports the following video mode for each model:

The 755CX SVGA model supports VGA (640-by-480 resolution) video mode and SVGA (800-by-600) video mode.

The 755CX VGA model supports VGA (640-by-480) video mode only.

Both models can display the computer output with up to 65 536 colors.

When you attach the external display that supports higher resolution than VGA, you can get a 1024-by-768 resolution video at maximum.

 To attach the external display:
Page 165.

 To change the display mode:
Page 166.

To display the computer output on the external display, you need to set the *display mode* appropriately. You can select one of the following display modes:

LCD only: The computer output is displayed only on the LCD.

CRT only: The computer output is displayed only on the attached external display.

When no external display is attached to the computer, the output is displayed on the LCD.

Both: The computer output is displayed on both the LCD and the external display.

When no external display is attached to the computer, the output is displayed only on the LCD.



Using the Display

Using a DOS Application with Your 755CX SVGA Model

When you use a DOS application that supports only VGA mode (640-by-480 resolution) with your 755CX SVGA model, the screen image might appear smaller than the display size shown in the following table. This is to maintain compatibility with DOS applications.

Note:

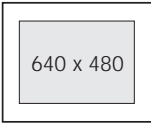
* When you select **Both**, do not attach the external display that supports only VGA mode (640-by-480 resolution). Otherwise, the screen of the external display is disordered and the output is not displayed.

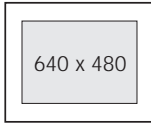
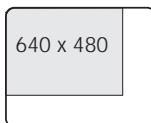
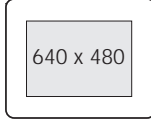
Display Mode			
LCD only	CRT only	Both	
		On the LCD	On the external display *
 <p>640 x 480</p> <p>The screen image appears in the center of LCD and looks smaller than the actual LCD size.</p>	 <p>640 x 480</p> <p>The screen image is the same size as the actual screen size.</p>	 <p>640 x 480</p> <p>The screen image appears in the center of LCD and looks smaller than the actual LCD size.</p>	 <p>640 x 480</p> <p>—or—</p>  <p>640 x 480</p>

Using the Online Book

Notes:

The online book is not available in all countries.

The online book is available only when the operating system is installed at the time of purchase.

You can view this *User's Guide* online to retrieve information when the hardcopy book is not available. The *online book* provides a very easy way of getting needed information when you are traveling.



Starting for OS/2 or Windows

Click on the **Online Book** icon.



Starting for DOS

1 Type **CD\READIBM** at the command prompt and press **Enter**.

2 Type **READIBM** and press **Enter**.
The menu for the online book appears. Choose any subject from the menu.

Hints and Tips

You can leave a "bookmark" or write notes as you read through the online book:

To leave the book with a bookmark, select **Place closing bookmark** when you exit the online book.

To write notes:

1. Position the cursor at the place where you want to write a note.
2. Select **Notes** from the action bar; then select **Create...** from the pull-down menu.
3. Write any note; then save it.

A symbol (>) is placed next to where you left the note. To read the note, select **Display/Edit...** from the **Note** pull-down menu.

Keeping the Computer from Being Damaged

Keeping the Computer from Being Damaged

Your computer is a delicate device that requires careful handling. To keep it from being damaged, keep these precautions in mind:

Do not apply shock to your computer.

Do not place anything heavy on your computer.

Do not pour liquid into your computer.

Do not leave any objects (especially metal objects) in the computer.

Keep the computer at least 13 cm (5 in.) away from any electrical appliance that generates a strong magnetic field such as a motor, magnet, TV, refrigerator, or large audio speakers.

Use your computer when temperatures are between 5°C to 35°C (41°F to 95°F).

Do not disassemble the computer.

Do not scratch, twist, hit, or push the surface of the LCD.

Remove the battery pack and keep it in a cool place if you will not be using the computer for a long period of time.

The removable hard disk drive and diskette drive are also very delicate devices that need careful handling. To avoid damage, do not press on them, drop them, or apply any shock to them when they are removed from the computer.

Do not press on the middle part of the diskette drive.

Insert a diskette straight into the diskette drive. Inserting it at an angle can damage the front of the diskette drive.

Do not place more than one diskette label on a diskette. Two or more labels can cause a label to tear apart inside the drive and cause damage to the diskette drive.

Occasionally clean your computer as follows:

Use a soft cloth moistened with nonalkaline detergent to wipe the exterior of the computer.

Gently wipe the LCD with a dry, soft cloth. Do not use alcohol or detergent.

Carrying the Computer

When carrying your computer, follow these instructions to prevent possible damage to your computer and data:

Note:

To reduce the weight of the computer when traveling, remove the diskette drive if you will not be using it.



To remove the diskette drive:
Page 150.

- 1** Remove any diskette from the diskette drive.
- 2** Turn off all attached devices.
- 3** Turn off the computer and close the LCD.
- 4** Unplug all external cables and cords connected to the computer.
- 5** Make sure all computer doors and covers are closed.

For Your Information

- 1.** You should occasionally back up data from the hard disk to diskettes or tapes.
- 2.** To use the AC Adapter outside your home country, you need an ac power cord that is certified for the country you are visiting. You can purchase one through IBM authorized reseller or IBM marketing representative in that country. For information about power cords, see “IBM Power Cords” on page 252.
- 3.** A carrying case is available from your IBM authorized reseller or IBM marketing representative.

Carrying the Computer

Chapter 3. Operating Your Computer

This chapter provides information about the use of your computer.

What Happens When Power Is Turned On?	34
Using the ThinkPad Features Program	35
Using the Program for OS/2 and Windows	36
Using the PS2 Program	41
Using the Batch File	41
Using Easy-Setup	42
Starting Easy-Setup	42
Selecting Easy-Setup Items	42
Using the Selectable Drive-Startup Sequence	47
Changing the Startup Sequence	47
Using the Fn Key Function	48
Using Power Management	50
Standby Mode	52
Suspend Mode	53
Safe Suspend	54
Considerations for Suspend Mode	55
Hibernation Mode	57
Creating the Hibernation File	59
Considerations for Hibernation Mode	60
Using PC Cards	61
About PC Cards	61
Limitations of Operation during Suspend and Hibernation Modes	61
Using the PC Card Director Program	62
Understanding the Meaning of Icons	63
Starting PC Card Director for OS/2	65
Starting PC Card Director for DOS	69
Starting PC Card Director for Windows	70
Using the Infrared Communication Feature	72
Considerations for Communication	74
Using the Mwave DSP Features	75
Using the Audio Function	78
For OS/2	78
For DOS	79
For Windows or WIN-OS/2	80
Using the Telephony Function	84
Connecting the Telephone Cable	84
Using the Mwave Modem	85
Mwave Data Modem	87
Using the Country Selection	88
Mwave Call Discriminator	88
Mwave Fax Modem	89
Mwave Telephone Answering Machine	90

What Happens after Power-On?

What Happens When Power Is Turned On?

One of the following prompts appears when the computer is turned on:

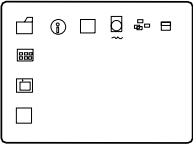
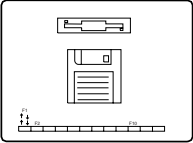
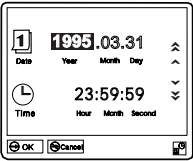
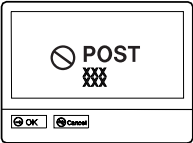
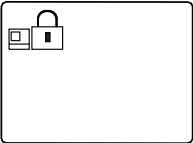
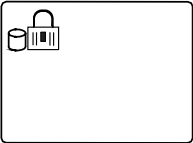
 <p>An operating system screen</p>	<p>An operating system screen appears when the computer is operating correctly. The screen appearance may differ depending on your operating system.</p>
	<p>This screen appears when an operating system is not found. It instructs you to insert a self-starting diskette into the diskette drive and press F1 to start the diskette. The order in which the computer checks the drives for an operating system is set in the drive-startup sequence. See "Using the Selectable Drive-Startup Sequence" on page 47 for more information.</p>
	<p>This screen instructs you to set the date and time for the first time. Enter the date and time (see page 44); then press Enter.</p>
	<p>This screen indicates that a failure occurred during the power-on self-test (POST). See page 207 for the necessary actions.</p>
	<p>This icon appears when a power-on password is set. To start the computer, enter the correct password.</p>
	<p>This icon appears when a hard-disk password is set. To unlock the hard disk drive, enter the correct password.</p>

Using the ThinkPad Features Program

 To install the ThinkPad Features program: Page 180.

ThinkPad Features is a program that allows you to select various features for your computer. The following shows the structure of the ThinkPad Features program:

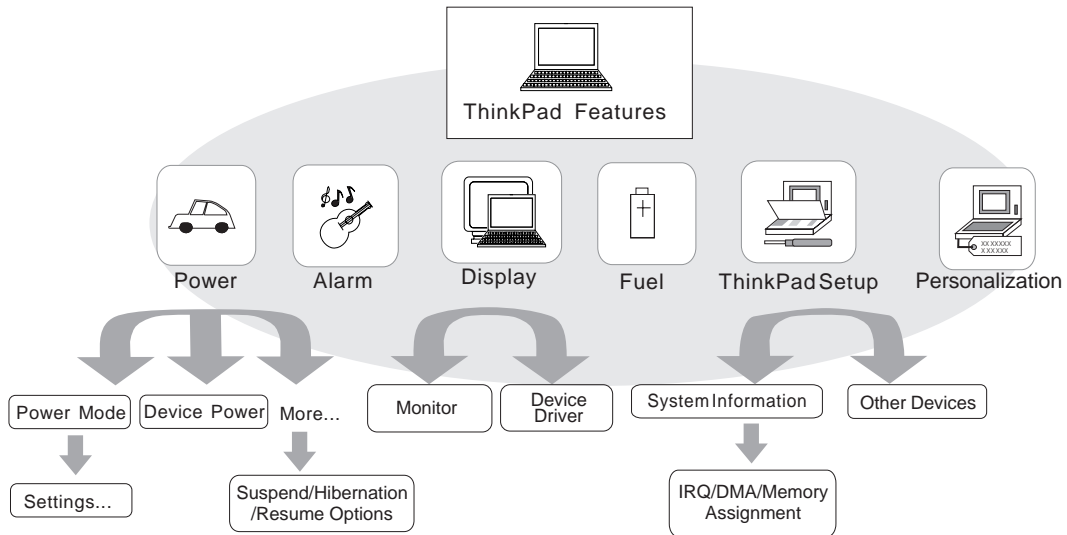

The way you start the ThinkPad Features program depends on which operating system is installed.

Using the ThinkPad Features Program



Using the Program for OS/2 and Windows

When you use OS/2 or Windows, a graphical presentation is available in the ThinkPad Features program.

Note:
The screen might be different from the actual one.

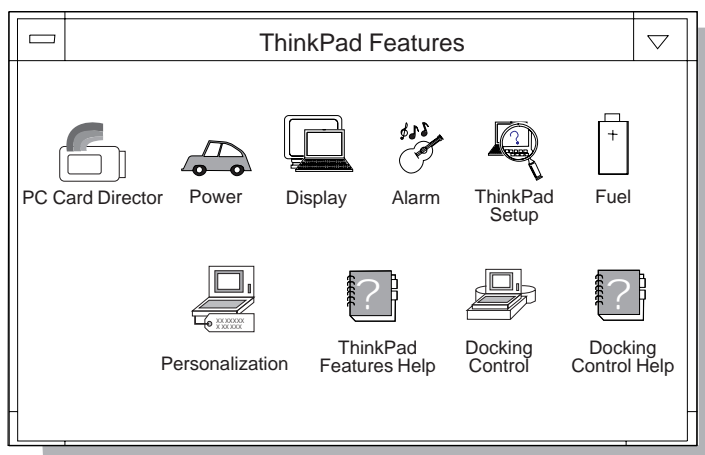

Hints and Tips

You also can use ThinkPad Features Program through the PS2 program from the DOS full-screen command prompt in OS/2 or Windows. For more information, see "Using the PS2 Program" on page 41.

A **Help** button is available on most menu screens. For additional information on each menu item, click on this button.



Power

Power Menu

When you select this icon, you can set power-saving options:

Power Mode for battery operation and AC Adapter operation.

You can select one of the following power modes:

Note:

* The values for both High Performance mode and Automatic mode are preset and cannot be changed.

Power-Saving Option	Power Mode		
	High Performance*	Automatic*	Customized
Standby timer	0	0	Your choice.
Suspend timer	60 minutes	15 minutes	Your choice.
Screen off timer	60 minutes	5 minutes	Your choice.
HDD stop timer	20 minutes	10 minutes	Your choice.
Processor speed	Maximum	Automatic clock control	Your choice.

Customizing power mode

To customize the power mode, such as the processor speed, select **Settings...** The power mode settings window appears on the screen. The values can be customized for each the battery-powered operation and the AC Adapter operation.

Power for devices

When you do not use such internal devices as the serial port or infrared port, you can save power by deleting the X in front of the device list.

Suspend, hibernation, and resume options

You can select suspend, hibernation, or resume options by clicking on the **More...** button.



Suspend, hibernation, and resume functions: Page 50.

Using the ThinkPad Features Program



Display Menu

The display menu allows you to make selections for the computer display.

Display devices

You can select the LCD, an external display, or both to use with the computer.

Device driver

You can select display resolution and color depth. You can also use the following function:

Virtual screen on the LCD and the external display: When you are using Windows, the virtual screen function is available. You can use it to display a part of the high-resolution screen image that is produced by the computer. Other parts can be seen by moving the screen using the TrackPoint III or another pointing device.

755CX SVGA model

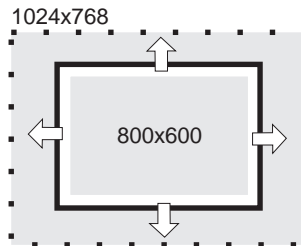

755CX VGA model

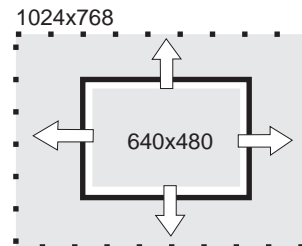

Note:

When the color depth is set to 65 536 or 32 768, the available virtual screen size is 800-by-600 resolution at maximum. To get a virtual screen with a 1024-by-768 resolution, set the color depth to 256.

Monitor

You can select the display type and refresh rate of the external display.

For more information, see “Attaching an External Display” on page 165.



Alarm

Alarm Menu

You can set the speaker to sound when the power status or the power mode is changed, or when battery power is low. You can also enable or disable the speaker indicator (see page 16) when the speaker sounds.

Note:

You can adjust the volume with the volume control. See page 12.

Using the ThinkPad Features Program



ThinkPad
Setup

ThinkPad Setup Menu

This menu allows you to view or set the following:

System Info

This shows you the system specifications and assigned resources (interrupt levels, DMA channel, and memory assignment) in the system.

Keyboard/Pointing Device

This allows you to enable the TrackPoint III. It also enables the *sticky Fn key function*, so **Fn** key functions are entered without your pressing and holding the **Fn** key.

For Windows users: You can also select the repeat-action speed of the keyboard and have a trailing cursor or select the shape and color of the pointing cursor.

Parallel

This allows you to enable the parallel port, select the port address (LPT1–LPT3), or set the direction of transfer and operating mode and view the interrupt levels.

Serial

This allows you to enable the serial port, select the port address (COM1–COM4), and view the interrupt levels.

DSP

This allows you to enable the DSP device for the Mwave functions, or view the I/O address, IRQ level, or DMA channel.

Infrared

This allows you to enable the infrared port or set the operating mode.

Video Controller

This allows you to set the memory address for the video BIOS.

Option Devices

This allows you to set I/O address, IRQ level, DMA channel, and memory address of the adapter information in the Dock I or II or other options.

Note:

You cannot use more than two serial devices at the same time. Serial devices include a device connected to the serial port, a modem in the diskette drive compartment, the infrared ports, the Mwave modem/fax (available as an option in some countries), and PCMCIA modem cards.

Using the ThinkPad Features Program

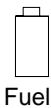

The **Fuel-Gauge** program shows you the following battery-power information:

- Remaining power percentage
- Current power mode
- Discharge options

 Fuel-Gauge program:
Page 98.



Personalization

The **Personalization Utility** program allows you to display personal data, such as your name and address, on the screen when the computer is turned on. These appear only when a password is set.

 Personalization Utility
program:
Page 125.



Docking
Control

The **Docking Control Utility** program allows you to attach the IBM Dock II to the computer without turning off the power.

Note:
For more information about the Docking Control Utility program, refer to the *Dock II User's Guide*.



Using the PS2 Program

Note:

To use the PS2 program in OS/2, you need to install the program using the same procedure as when installing for DOS. See page 181.

Note:

The screen might be different from the actual one.

To start the PS2 program, type **PS2** or **PS2 ?** at the command prompt; the press **Enter**. The following help screen appears:

```
C:\> PS2 ?

(C)Copyright IBM Corp. 1993,1995. All rights reserved.
  US Government Users Restricted Rights - Use, duplication
  or disclosure restricted by GSA ADP Schedule Contract
  with IBM Corp.

Command Syntax: PS2  [Parameter1] [Parameter2] [Parameter3]

Following are available [Parameter1].
For the complete command syntax, type 'PS2 ? [Parameter1]'.

1.Power Management related
PMode,  SERial,  DDC,      CARD,      DSP,
IR,     POver,   LCd,      DISK,
SPeed,  SStandby, DISCHARGE, DEFAULT, Cover,
```

You can select an item from the menu and follow the instructions on the screen to set any of the features.

Using the Batch File

You also can specify features by entering appropriate commands, or you can create a batch file and set your unique operational environment with the commands.

The following sample batch file would provide an operational environment suitable for traveling, and could result in a longer-battery operation time.

Note:

Refer to the manuals supplied with the operating system for more information on batch files.

```
@Echo Off

Rem SAMPLE: Set the parameters to provide maximum power utilization.
Rem =====
          PS2 PMode Custom                > Nul
          PS2 LCd 3 minutes                > Nul
          PS2 DISK 3 minutes              > Nul
          PS2 POver 5 minutes              > Nul
          PS2 SPeed Fixed MIN              > Nul
          PS2 IR OFF                       > Nul
          PS2 CARD OFF                     > Nul
          PS2 DDC OFF                       > Nul
```

Using Easy-Setup

Using Easy-Setup

Warning:
Do not enter suspend mode when using Easy-Setup.

The computer has a built-in system setup function called *Easy-Setup*. Easy-Setup allows you to set the date and time, passwords, the startup sequence of the drives, and various hardware configurations, such as keyboard speed and serial- and parallel-port addresses. Easy-Setup also runs the diagnostics.

Starting Easy-Setup

To start Easy-Setup, do the following:

- 1 Turn off the computer.
- 2 Remove any diskette from the diskette drive.
- 3 Press and hold **F1**; then turn on the computer. Hold **F1** until the *Easy-Setup* menu appears.

Note:
You can change the screen color of the *Easy-Setup* menu with **Ctrl+PgUp** or **Ctrl+PgDn**. Use **Ctrl+Home** to restore the original screen color.

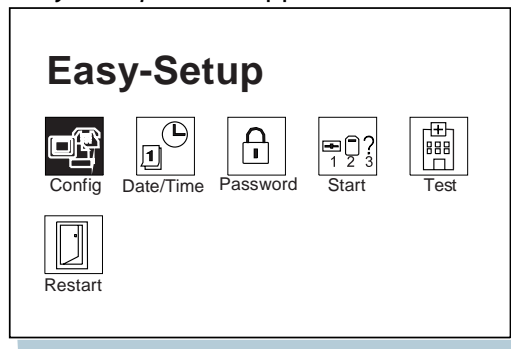

Selecting Easy-Setup Items

To select an item from the *Easy-Setup* menu, move the pointer with a pointing device to the item and click on the item or use the keyboard as follows:

Arrow keys (↑↓←→): Highlight the item from the menu.

Spacebar: Selects the item.

Enter key: Enters the next menu, or saves the changes and exits the menu.

Esc key: Returns to the previous menu, or cancels the changes.

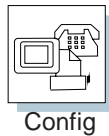

Config contains the following:

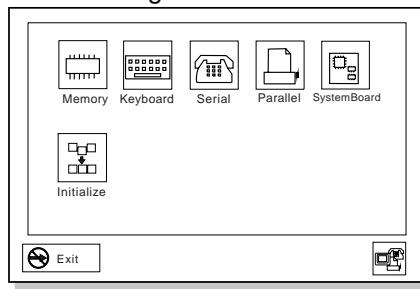

Memory shows the amount of installed memory and available memory remaining.

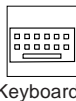

Keyboard enables you to set the repeat-action (typematic) speed and enables or disables the TrackPoint III.



Serial enables you to select the port address for a serial device connected to the serial port, or for the internal serial device in the diskette-drive compartment.

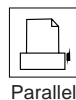

Parallel enables you to select the port address for a device, such as a printer, that is connected to the parallel connector. When you select **Bidirectional**, the data transfer between the selected port and the device is in both directions. When you select **Unidirectional**, the data transfer is in only one direction: from the computer to the device.

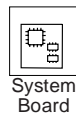

SystemBoard provides information about the installed system board.



Initialize sets all items in the Config menu to their original values.

After verifying the selections, click on **OK** or press **Enter**. To cancel the selections, press **Esc**.

Using Easy-Setup

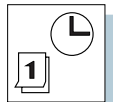

Date/Time

Date/Time is used to set the current date and time.

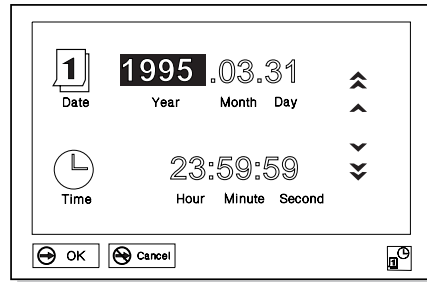

Select any field (Year, Month, Date, Hour, Minute, or Second) with the **Arrow** key or pointing device; then type or click on the **▲** or **▼** icon to change the setting. Clicking on the **▲** or **▼** icon changes the setting more quickly.

After verifying the selection, click on **OK** or press **Enter**. To cancel the setting, click on **Cancel** or press **Esc**.



Password

Password is used to set:

- Power-on password
- Hard-disk password
- Supervisor password

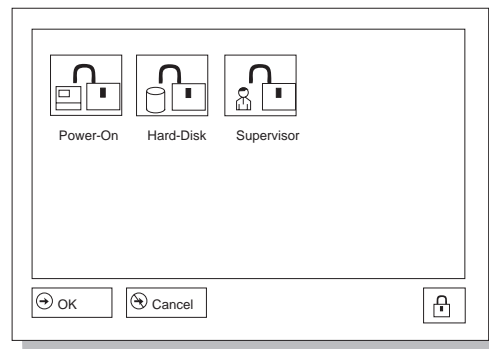

For more information about the passwords, see Chapter 5.

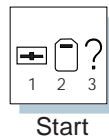

Start up is used to change the startup sequence of your computer.

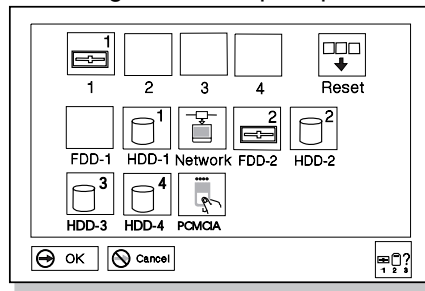

Note:
For more information about the startup sequence, see “Using the Selectable Drive-Startup Sequence” on page 47.

The **HDD-1** icon represents the internal hard disk drive of the computer. The other numbered HDD icons are the hard disk drives of external devices. **FDD-1** represents the first diskette drive found during system startup. When no diskette drive is installed and the attached expansion unit (Dock I or II) has a diskette drive, the diskette drive in the Dock I or Dock II will be the first drive.

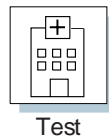

Select **Test** to test the computer hardware.

Note:
The **FDD-1** and **HDD-1** icons represent the diskette drive and hard disk drive of the computer, respectively. Other numbered icons are the diskette drive and hard disk drives of external devices.

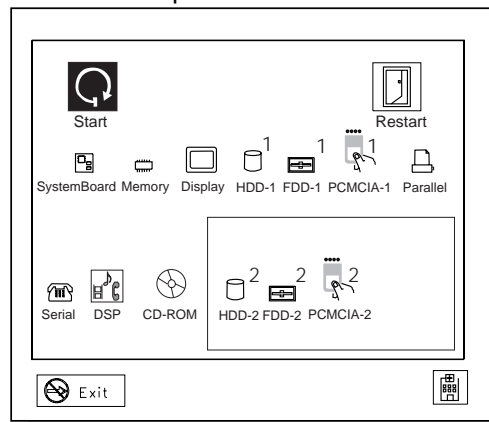

For more information, see “Testing the Computer” on page 202.

Using Easy-Setup

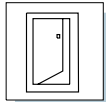

Restart

Click on **Restart** to restart the computer after you have made your selections. Then press **Enter** or click on **OK**.

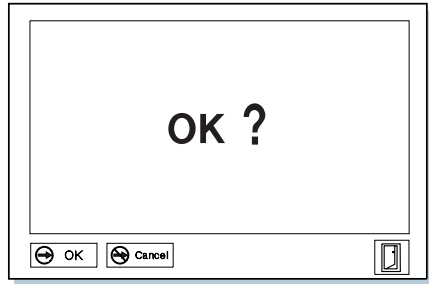

Using the Selectable Drive-Startup Sequence

Warning:

If you change your startup sequence, you must be extremely careful when you do write operations (such as copying, saving, or formatting). Your data or programs can be overwritten if you select the wrong drive.

Selectable drive startup (*selectable boot*) allows you to control the startup sequence of the drives in your computer. The order in which the computer searches the drives for your operating system is the *drive-startup sequence*. If you are working with multiple operating systems, you might want to change the drive-startup sequence to load the operating system from the hard disk or the PC Card without checking the diskette drive, or to do a remote program load (RPL).

Changing the Startup Sequence

To change the startup sequence, do the following:



To start Easy-Setup:
Page 42.

1 Start Easy-Setup and select the **Start up** icon.

2 Move the cursor to the **Reset** icon; then press the **Spacebar**.

The sequence is reset, and all available device icons appear at the bottom of the screen. For the meaning of icons, see page 45.

3 Move the cursor to the icon of the first device for the startup sequence; then press the **Spacebar**.

Repeat this step to set the other devices for the startup sequence. You can set up to four devices.

4 Click on **OK** or press **Enter** to save the change.

Note:

You cannot set a hard disk drive before the PC Card in the startup sequence.

Using the Fn Key Function

Using the Fn Key Function

The **Fn** key function allows you to change operational features instantly. When you use the following functions, press and hold the **Fn** key 1 ; then press the appropriate function key 2 .

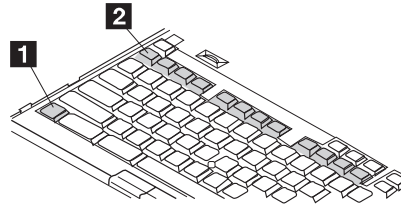

Note:



















To use the sticky **Fn** key function, select **Keyboard/Pointing Device** from the *Setup* menu of the ThinkPad Features program window or **PS2 FNS E** command.

Hints and Tips

Using Sticky Fn Key Function: Once you press the **Fn** key, you get the same effect as when you press and hold the **Fn** key until you press any function key.

Key Combination	Feature	Meaning
+	Reserved	—
+	Fuel-Gauge program display on or off 	The Fuel-Gauge program must be activated before you can use this key combination. When the this key combination is pressed: For OS/2 or Windows users: The window for the battery-power status appears or disappears. Parameters for power status can be set. For DOS users: Power status information appears or disappears at the top-right corner of the screen.
+	Standby mode 	Places the computer in standby mode. For more information about this mode, see page 52.
+	Suspend mode 	Places the computer in suspend mode. For more information about this mode, See page 53.
+	Reserved	—
+	Reserved	—
+	LCD/external display switching 	Displays the computer output in the following order when an external display is attached. External Both Display LCD

Using the Fn Key Function

Key Combination	Feature	Meaning
 + 	Reserved	—
 + 	Reserved	—
 + 	Reserved	—
 + 	Power mode switching 	When this key combination is pressed during battery-power operation, the power-management (power-saving) mode changes as follows. See page 37. High Auto Customize The AC mode is used when the AC Adapter is attached. The Fuel-Gauge program displays the current-power option.
 + 	Hibernation mode 	Places the computer in hibernation mode. See “Hibernation Mode” on page 57 for more information.
 + 	Dock I speaker volume up 	Increases the speaker volume of the Dock I attached to the computer.
 + 	Dock I speaker volume down 	Decreases the speaker volume of the Dock I attached to the computer.

Using Power Management

 To use the ThinkPad Features program:
Page 35.

Note:
When installing the operating system, install the ThinkPad Features program to use Power Management.

 To install the ThinkPad Features program:
Page 180.

The computer supports the following power-saving modes as a built-in power-saving functions:

Operation Mode

You can choose one of the following to operate your computer. (See page 37 for more information.)

- **High Performance**
The computer performance is considered first, although power is automatically saved.
- **Automatic**
The power-saving parameters are automatically set to save as much power as possible.
- **Customized**
You can customize all parameters to save power.

Standby Mode

Enter standby mode for short idle times—for example, when you are having a short conversation with someone. (See page 52 for more information.)

Suspend Mode

Enter suspend mode for short periods of time away from your computer. (See page 53 for more information.)

Hibernation Mode

Enter hibernation mode when you leave your office and then return the following day. (See page 57 for more information.)

In addition to these, you can use the **resume function**. When resuming normal operation from one of the power-saving modes such as standby mode, suspend mode, or hibernation mode, the computer returns to where it was when it entered the mode. Because the operating system is already loaded, the resume function is faster than when turning on power.

A comparison of the power conserved and the time required to return to operation mode is shown in the following figure:

Using Power Management

Power-saving-modes→	Standby	Suspend	Hibernation
Time required to return to normal operation.			
Amount of power consumption.			

The following figure shows the operations required when the computer moves from a power-off condition to an operational mode, and vice versa. The battery shows the amount of battery power used in each stage.

 To set the timer:
Page 35.

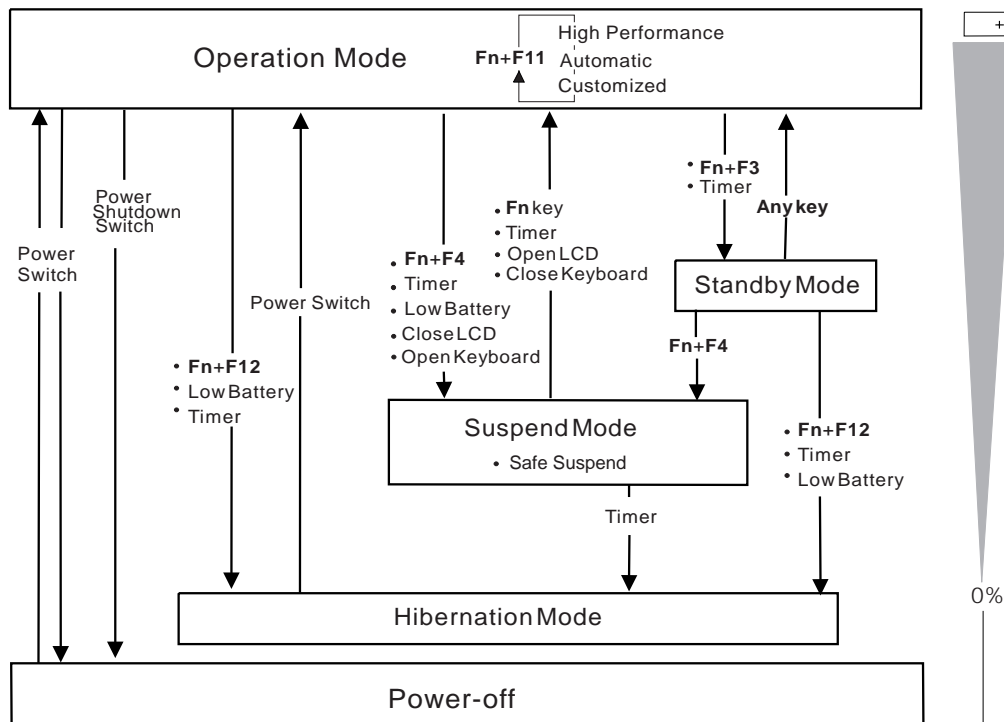

Using Power Management

Standby Mode

In standby mode, the hard disk drive stops and the LCD turns off to save power. When any key is pressed, the computer immediately resumes normal operation.

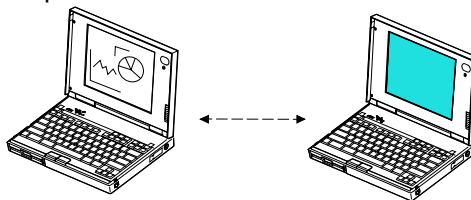

The following shows what causes the computer to enter standby mode and resume normal operation:

 **Fn** key function:
Page 48.

 ThinkPad Features program:
Page 35.

To Standby Mode

Fn+F3 key combination is pressed.

No activity occurs during the time specified by the *Standby timer* of the ThinkPad Features program.

To Normal Operation

Any key is pressed.

Pointing device activity occurs.

Suspend Mode

In suspend mode, all tasks are stopped and stored in memory to save power. When the computer resumes normal operation, the tasks are automatically restored.

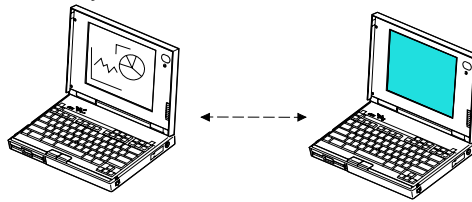

The following shows what causes the computer to enter suspend mode and to resume normal operation:

 **Fn** key function:
Page 48.

 ThinkPad Features program:
Page 35.

 **PS2** command:
Page 41.

To Suspend Mode

The **Fn+F4** key combination is pressed.

The LCD is closed.

The **PS2** command to enter suspend mode is used.

The **suspend** button is pressed in the Fuel-Gauge program.

No activity occurs during the time specified by the *Suspend timer* of the ThinkPad Features program.

A low-battery condition is detected.

The keyboard is opened.

To Normal Operation

The **Fn** key is pressed.

Any key is pressed when the AC Adapter is being used.

The LCD is opened.

The **PS2** command to resume is used.



The **Resume on timer** option is set in the ThinkPad Features program.

The ring indicator is received through the communication interface.

The keyboard is closed.

Using Power Management

The current status of the computer is shown by the following indicators:

Current Status	Indicators	
	 Suspend Mode	 Power-On
In suspend mode	Green	Off
Entering or resuming suspend	Blinking green	Off
Normal operation	Off	Green

Safe Suspend

Warning:
Do not move the computer when it is entering safe suspend mode.

Note:
Before using safe suspend mode, you need to create a hibernation file. See page 59.

 ThinkPad Features program:
Page 35.



For OS/2 or Windows:

- 1** Start the ThinkPad Features program.
- 2** Select **Power**; then select the **More...** button.
- 3** If a hibernation file has not been created, click the **Enable hibernation** button and create the file on the internal hard disk.
- 4** Click on the **Safe suspend** box.
- 5** Select the **OK** button.

DOS

For DOS:

 **PS2** command:
Page 41.

1 If a hibernation file has not been created on the hard disk, type **PS2 HFILE X**; then press **Enter** to create a hibernation file.

2 Type **PS2 SA E** at the command prompt; then press **Enter** to enter safe suspend mode.

Considerations for Suspend Mode

Consider the following before using suspend mode:

Attached devices, such as a printer or serial device, stop running when the computer enters suspend mode. When normal operation is resumed, the output can differ from what you expect, because the device might be reset or lose its configuration settings.

When a power-on or hard-disk password is set, you must enter your password to resume normal operation.

The computer can enter suspend mode when used with the following operating systems:

- DOS Version 7.0 or later
- OS/2 Version 2.11 or later
- Microsoft Windows Version 3.11 with DOS Version 7.0 or later

Important

When you use Windows Version 3.11, ensure that Advanced Power Management (APM) is installed according to the instructions in “Microsoft Windows Version 3.11 or Later” on page 177.

Note:

When the computer enters standby mode, you will hear a beep that is different from the one that sounds when entering suspend mode.

When the computer is powered with ac power and is using one of the following IBM PC Cards, it enters standby mode:

- IBM 3270 Emulation Credit Card Adapter
- IBM 5250 Emulation Credit Card Adapter
- IBM Token-Ring 16/4 Credit Card Adapter
- IBM Credit Card Adapter for Ethernet

When other PC Cards are used, all application programs stop, and for some of these PC Cards the power to the PC Cards might also turn off.

Using Power Management

When the computer is powered with battery power, it turns power off to the PC Card, so the duration of suspend mode is longer. When resuming normal operation, if the PC Card or computer does not operate, restart the application or computer.

When the computer is using one of the following IBM modem cards and detects an incoming call while in suspend mode, it automatically resumes normal operation:

- IBM PCMCIA Data/FAX Modem
- IBM High Speed PCMCIA Data/FAX Modem

While the communication link is active, the computer will not enter suspend mode.

Hibernation Mode

Note:

Using the Dock I, Dock II or a particular PC Card disables hibernation mode.

Note:

The time to enter or exit hibernation mode depends on the size of computer memory.

Before using hibernation mode, you must create a *hibernation file*. See page 59 for instructions.

During hibernation mode, all tasks are stopped, and memory data and the current status of the computer are stored on the hard disk drive; then the power is turned off. When power is turned on again, the computer automatically restores the tasks and resumes normal operation. No battery power is used when the computer is in hibernation mode.

It takes approximately 10 seconds to enter hibernation mode, and 18 seconds to resume normal operation (with a base memory of 8MB). When the computer is entering hibernation mode, you receive a screen message, the computer sounds one short beep, and the suspend indicator blinks. You also will hear one short beep when the hibernation process is completed.

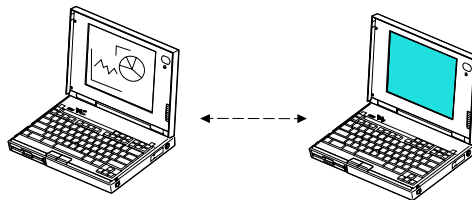

Using Power Management

The following shows what causes the computer to enter hibernation mode and to resume normal operation:

 **Fn** key function:
Page 48.

 ThinkPad Features program:
Page 35.

 **PS2** command:
Page 41.

To Hibernation Mode

The **Fn+F12** key combination is pressed.

The **PS2 HIB** command is used.

The **hibernation** button is pressed in the Fuel-Gauge program.

The time specified by the hibernate option after the expiration of suspend mode.

No activity occurs during the time specified by the *Suspend timer* of the ThinkPad Features program.

A low-battery condition is detected.

The power switch is pressed, when the **Hibernate by power switch** option is set.

To Normal Operation

The power switch is pressed.

Creating the Hibernation File

Warning:
The hibernation file must not be created in a compressed data area of the hard disk or external drive.

When installing the operating system, or if you have expanded the computer memory, you must create a hibernation file on the hard disk drive to use hibernation mode.

The size of the hibernation file will be greater than total memory. For example, if base memory is 8MB and you have installed an optional 4MB IC DRAM card, the hibernation file is 13MB: (8MB plus 4MB) plus 1MB.

The following describes how to create a hibernation file for your operating system.



 To start the ThinkPad Features Program: Page 36.

For OS/2 or Windows:

1. Turn on the computer and start the ThinkPad Features program.
2. Select **Power**; then select **More...**
3. Click on the **Enable Hibernation** button in the *Suspend Options* menu.
4. Make sure the hard disk drive in the computer is selected; then click on the **OK** button to create the hibernation file.

The computer can now enter hibernation mode.



 **PS2** command: Page 41.

For DOS:

1. Turn on the computer.
2. Type **PS2 HFILE C** at the command prompt and press **Enter**.
C can be any drive letter up to Z.

The computer can now enter hibernation mode.

Using Power Management

Considerations for Hibernation Mode

Consider the following before using hibernation mode:

Do not run any tasks while the hibernation file is being created.

Create the hibernation file only on the hard disk drive installed in the computer.

The hibernation file is hidden and cannot be accessed.

The computer uses battery power to enter hibernation mode. Therefore, it reserves some battery power when it is set to enter hibernation mode at a low-battery condition. This can cause the battery operating time to be shorter than the time shown on page 20 and 21.

When the computer is powered with ac power and is using one of the following IBM PC Cards, it does not enter hibernation mode:

- IBM PCMCIA Data/FAX Modem
- IBM High Speed PCMCIA Data/FAX Modem
- IBM 3270 Emulation Credit Card Adapter
- IBM 5250 Emulation Credit Card Adapter
- IBM Token-Ring 16/4 Credit Card Adapter
- IBM Credit Card Adapter for Ethernet

This prevents possible problems from occurring with communication application programs after the computer returns to normal operation.

Note:

If communication does not restart automatically, remove the PC Card and insert it again; then restart the application or computer.

When the computer is powered with battery power, it turns power off to the PC Card. When you resume normal operation, if the PC Card or computer does not operate, restart the application or computer.

Using PC Cards



To insert the PC Card:
Page 134.

Your computer has two slots that allow you to install one or two credit-card-size PC Cards. With a PC Card, you can communicate via a network, or you can store data.

About PC Cards

The slots conform to PCMCIA Standard Release 2.1 (or later), which is defined as the hardware layer of the PCMCIA standard. Your computer comes with the following basic set of device drivers for PC Card support:

- Socket Services Release 2.1
- Card Services Release 2.1
- PC Card Director



PC Card Director:
Page 62.

Card Services and Socket Services are the basic drivers required for all PC Cards. The PC Card Director sets up the PC Cards so they are ready to be used as soon as you insert them in the PCMCIA slot of the computer.

The PCMCIA slots support *Type I*, *Type II*, and *Type III* PC Cards. You can use two Type I or Type II PC Cards or one Type III PC Card in the PCMCIA slots. However, because the Type III PC Card is thicker than Type I or Type II PC Cards, you cannot use other types of PC Cards when using the Type III PC Card. Ask your IBM authorized reseller or IBM marketing representative for more information about the different types of PC Cards.

For more information about PC Cards, see Appendix B.

Limitations of Operation during Suspend and Hibernation Modes



Suspend mode:
Page 53.

Some PC Cards can be installed or removed without turning off the computer (refer to the instructions that came with the PC Card), but you *cannot* remove or install PC Cards during suspend mode.



Hibernation mode:
Page 57.

Some PC Card types do not support hibernation mode.

Using PC Cards

Using the PC Card Director Program

 Auto Configurator:
Page 231.

The PC Card Director is an advanced IBM program that makes it easy to use PC Cards by:

Turning on and setting up a PC Card when you plug it in (by using *Auto Configurator* program).

Showing what types of PC Cards are in your computer.

Notifying you with a pop-up message, a beep, or icons whenever a card is inserted or removed.

Allowing you to register an application program for a particular PC Card and starting the program automatically when the card is inserted.

 To install PC Card Director:
Page 183.

PC Card Director is on the PCMCIA Features Diskette and must be installed before you can use it.

PC Card Director requires the Socket Services and Card Services drivers.

Note:
The PCMCIA.CRD file does not always list the latest PC Cards. If your PC Card is not listed, try using it with PC Card Director anyway.

Some PC Cards come with their own drivers that will set the cards up just as PC Card Director does. However, if these cards are supported by PC Card Director, you will not need their drivers. The supported PC Cards are listed in the **PCMCIA.CRD** file on the PCMCIA Features Diskette.



If your PC Card is not supported by PC Card Director, you must install the driver that came with your card. The card driver must be compatible with PCMCIA Card Services Standard, Release 2.0 or 2.1. Follow the instructions in the card driver's manual to install the driver.

Understanding the Meaning of Icons

The PC Card Director uses various icons to show you the status of the PCMCIA slots and the type of PC Card installed.



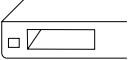
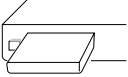

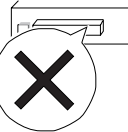
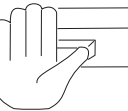

A **Help** button is available on most PC Card Director menu screens. To obtain additional information for each screen, click on this button.

Status Icons

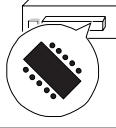
Icon	DOS Message	Meaning
	Empty	No PC Card is installed in the slot.
	—	A PC Card is installed.
	Ready	The PC Card in the slot is ready to be used.
	Not Ready	The PC Card is not ready and cannot be used.
	Non Removal	The PC Card cannot be removed.

Using PC Cards

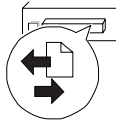
Card-Type Icons

Icon	DOS Message	Meaning
	Memory	Memory card
	Hard Disk	Hard disk card
	LAN	Communication card
	Modem	Modem card
	(Depends on the type of your PC Card.)	I/O card
	Boot	DOS was booted from the PC Card that is installed.
	Boot	OS/2 was booted from the PC Card that is installed.



Starting PC Card Director for OS/2:
Click on the **PC Card Director** icon on the OS/2 Desktop.



PC Card Director

The following screen appears. “No. 1” is for the upper PCMCIA slot, and “No. 2” is for the lower slot.

Descriptions of the icons are on page 63.

PCCardDirector			
View Options Help			
PCMCIA Socket - Detail View			
No.	Status	CardType	CardInformation
1			
2			x:XXXXXXXXXX,XXXXX-XX-XXXX

To view the details of a PC Card, select the slot with a pointing device, or use the **Arrow** keys and press **Enter**.

Using PC Cards

The following choices appear in the **View** pull-down menu:

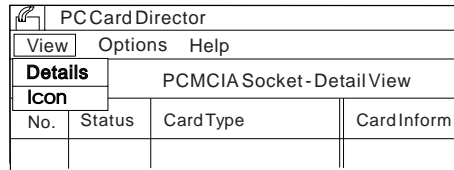

Details shows the current status of the PCMCIA slots and provides information about the installed PC Cards.

Icon shows the slot information with the slot number and the PC Card type. You can minimize the screen and keep it on the OS/2 Desktop to view the slot information.

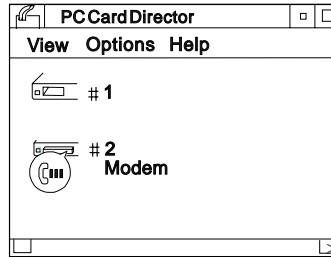

If you select **Options**, the following choices appear:

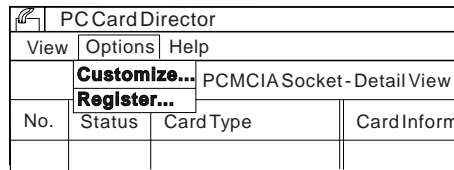

Customize... sets beeps on or off or activates pop-up windows when a PC Card is inserted or removed.

Register... registers, updates, or deletes the PCMCIA application program installed for the PC Card.

Using PC Cards

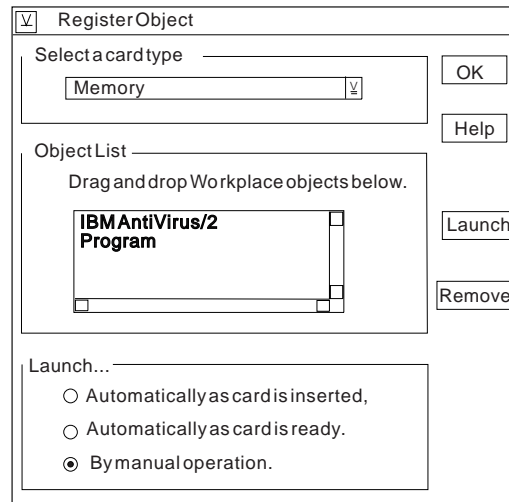

After you register an application program, you can set it to start automatically when you insert the PC Card by selecting **Automatically as card is inserted**. You can register more than one application program for a PC Card. When you insert the card, the application programs are listed on the screen so you can select the one you want.

Using PC Cards

To register a PCMCIA application program, do the following:

1. Select the type of PC Card on which the application program is to run.
2. Type the application name in the **Object List** box or *drag and drop* the icon of a program in the workplace of the Object List.

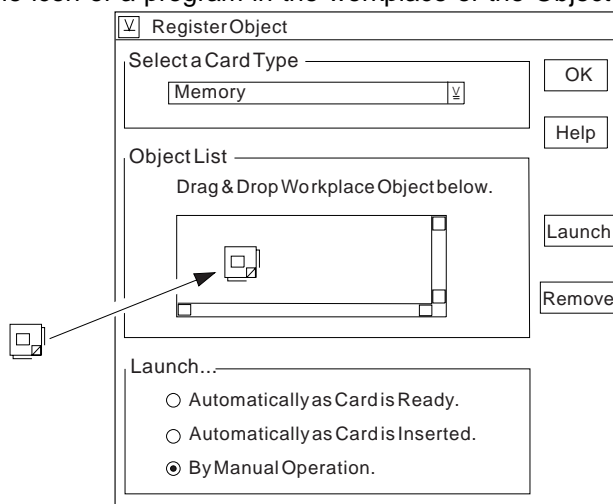

3. Select a choice from the **Launch...** box to run the application program automatically or manually.

Help is available on most menu screens for additional information.



Starting PC Card Director for DOS

To start PC Card Director, type **C:\THINKPAD\EZPLAY** at the DOS prompt; then press **Enter**. The following screen appears. “Socket 1” is for the upper PCMCIA slot, and “Socket 2” is for the lower one.

```

                                PC Card Director
                                (c) Copyright IBM Corp. 1995, Version x.xx
Card Services  DOS Card Services Driver, Version x.xx PCMCIA Card Services
                                Release  x.xx      Revision  x.xx
Socket Information
Socket   Status      Card Type      Card Information
      1   Empty
->  2   Ready       Memory       x:xxxx xxxx, xxx xx-xx-xx xx
```

To view more information about an installed PC Card, highlight the item with the **Arrow** keys (↑, ↓); then press **Enter**.

Using PC Cards



Starting PC Card Director for Windows

Note:
PC Card Director for Windows runs only in Enhanced mode of Windows 3.11 or later version.

Select **PC Card Director** in the ThinkPad window.

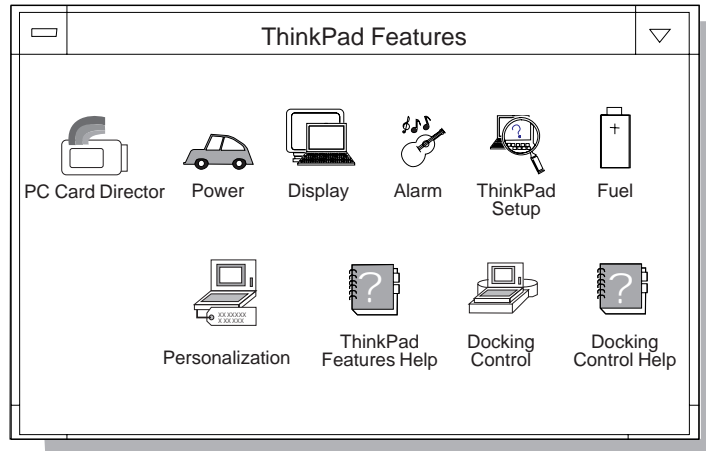

The following screen appears. “No. 1” is for the upper PCMCIA slot, and “No. 2” is for the lower one.

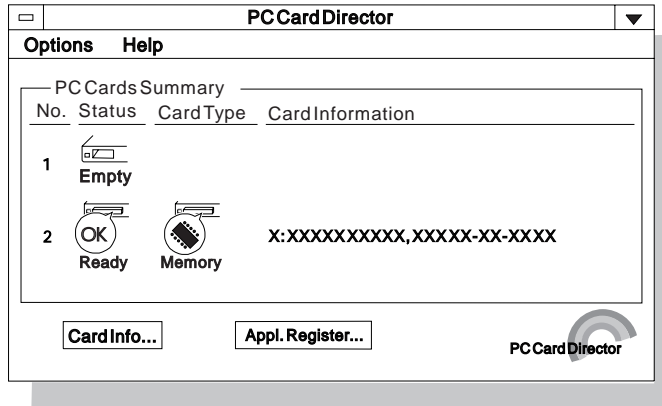

Card Info... shows details of a PC Card installed in a PCMCIA slot. To view information about a PC Card, highlight the item with the **Arrow** keys (↑, ↓) or pointing device; then click on this button. You also can register a PC Card type, when a card type appears as unknown.

Appl. Register... registers, changes, or deletes a PC Card application program. An application can run automatically according to the PC Card type, if you specify the **Run Automatic**

Using PC Cards

option. If you register more than one application for each type of PC Card, select the application you want to run from the list that appears when the PC Card is installed.

If you select **Options** from the menu bar, the following choices appear:

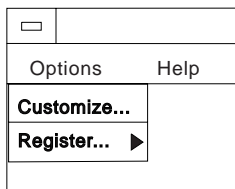

Customize... sets beeps on or off or activates pop-up windows when the details of an installed PC Card change. It also sets whether a single icon or multiple icons are used when the PC Card Director screen is minimized. The following shows the two types of minimized PC Card Director icons:

Single icon



PC Card Director

This icon temporarily changes when a PC Card is removed or installed if the **Pop up Main Window** option is not specified.

Multiple icons

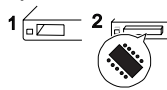

PC Card Director

These icons show the card status of both PC Cards installed in the slots.

The icon for each slot temporarily changes when a PC Card is removed or inserted if the **Pop up Main Window** option is not specified.

Register... does the following:

Register Applications registers, changes, or deletes an application program according to the PC Card type, even when a PC Card is not installed in the slot.

Change Card Type changes a registered PC Card type to another type.

Help is available on most menu screens for additional information.

Communicating with the Infrared Port

Using the Infrared Communication Feature

Note:

When installing an operating system, you must install the infrared device driver to use the ThinkPad mode.



To install infrared device driver:
Page 196.

Notes:

Mbps: Million bits per second

Kbps: Kilobits per second

Your computer is equipped with an infrared (IR) communication feature that allows point-to-point communication with other ThinkPad computers or systems equipped with an infrared port. The computer has two infrared ports, one in the front of the computer below the diskette drive and another on the rear of the computer.

The infrared feature supports three modes with the following communication speed in bits per second (bps):

ThinkPad (1.15 Mbps)

This mode is used when communicating with another 755 series computer with an infrared port or other systems supporting ThinkPad mode.

Generic (up to 115 Kbps)

This mode is used when communicating with other IBM ThinkPad computers, Hewlett-Packard** 100LX**, 200LX**, Omnibook**, or other systems with infrared ports supporting Generic mode.

Sharp (9600 bps)

This mode is used when communicating with the Sharp** Wizard** or other systems with infrared ports supporting Sharp mode.

The ThinkPad Features program contains a utility program that enables the front or rear infrared port and the communication speed.

If you are using OS/2 or Windows: See page 39.

If you are using DOS: Type **PS2 ? IR** at the command prompt; then press **Enter** for more information.



PS2 command:
Page 41.

Communicating with the Infrared Port

During communication with rear infrared ports, the infrared ports must face directly with each other at a communicating distance.

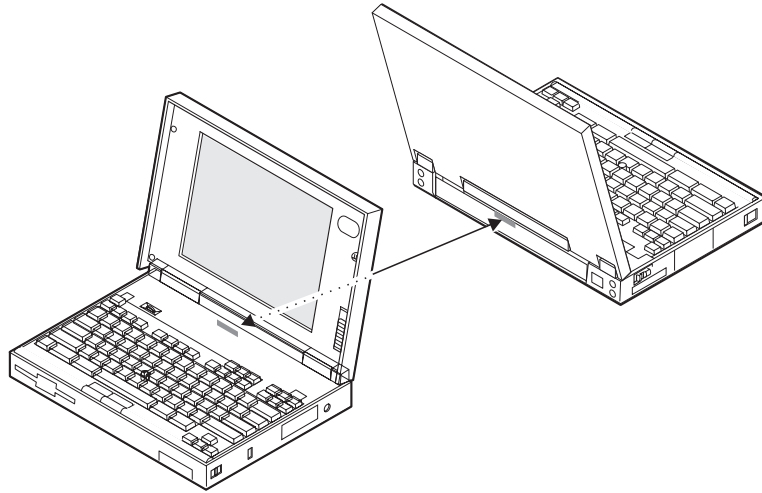

It is recommended that the communicating ThinkPad computers use their rear infrared port to communicate with each other.

When communicating between a front infrared port and an infrared port on another computer, the infrared ports on the computers must face directly each other at a communicating distance.

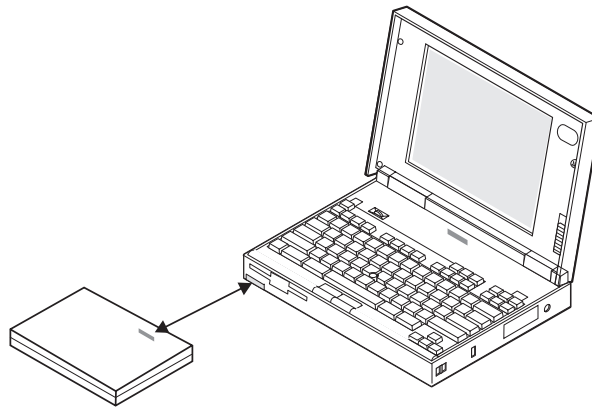

Communicating with the Infrared Port

Communication can be affected by the light from the LCD of the computer. To avoid this, open the LCD of the computer to a wide angle:

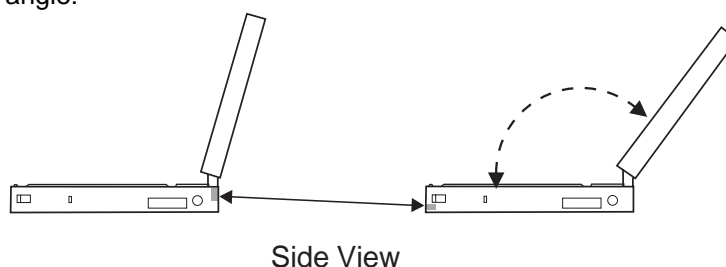

Considerations for Communication

Consider the following when communicating with the infrared ports.

You need to run the same communication application to communicate between your computer and the other computer or device. Refer to the application manuals for more information.

Run only one application at a time to communicate with the infrared ports.

When using applications that use a conventional serial port and serial cable to exchange data, your computer infrared ports are used as a replacement for the serial port and cable. In this case, the ThinkPad mode cannot be used.

The communicating distance might be less if:

- The other system is not the same model as your computer.
- There is interference from the ambient light. It is recommended not to use infrared communication during bright sunshine or artificial light conditions.
- The infrared port is not directly facing the other communicating port.

Using the Mwave DSP Features

Note:

In some countries, the Mwave telephony functions are available only after the DAA/Telephony Kit option is installed.

Note:

You can use an electric condenser microphone (with battery) for sound recording.

Note:

For more information about MIDI, see "Mwave MIDI Overview" on page 244.

The computer provides an Mwave system, which is based on the *digital signal processor (DSP)*. It gives you the best performance when you use it for audio and telephony functions, and it supports a more natural way of communicating with your computer.

The Mwave DSP system supports a full complement of audio and telephony functions including the following:

Audio functions:

- Supports the wave audio record and playback up to 16-bit, stereo and 44 kHz sampling
- Provides a high-quality MIDI wave table synthesizer with 128 instruments and up to 32 voices
- Supports DOS games by using the Sound Blaster** interface

Telephony functions:

- Supports data modem up to 14 400 bps
- Supports fax modem up to 14 400 bps
- Supports speaker phone function
- Supports telephone answering machine function

Using the Mwave DSP Audio Features

Note:
In some countries, the Mwave telephony functions are available after the DAA/Telephony Kit option is installed.

The following shows the connection between the computer and the external cables or devices:

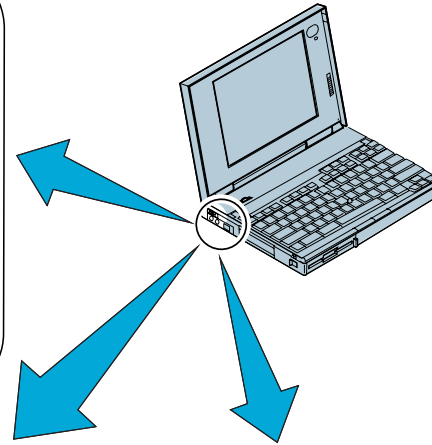
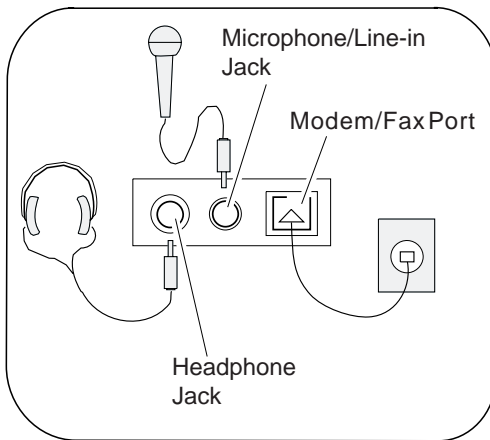

When the DAA/Telephony Option Kit is installed:

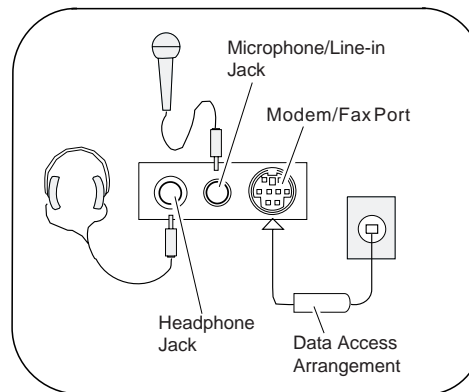
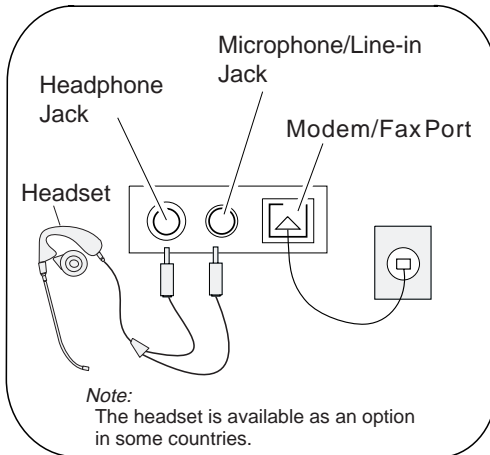

Using the Mwave DSP Audio Features



To install the Mwave DSP support software:
Page 192.

The Mwave DSP supports the following functions for each operating system.



For OS/2:

- Wave audio record and playback
- MIDI synthesizer
- Sound Blaster support in the DOS session
- Data modem



For DOS:

- Sound Blaster support
- Data modem



For Windows:

- Wave audio record and playback
- MIDI synthesizer
- Sound Blaster support in the DOS session
- Data modem
- Fax modem
- Speaker phone
- Telephone answering machine

Using the Mwave DSP Audio Features

Using the Audio Function

Use the Mwave audio functions according to your operating system.



For OS/2

The Mwave feature supports the audio function in the OS/2 environment through Multimedia Presentation Manager/2 (MMPM/2). To use the Mwave audio functions with OS/2, refer to the MMPM/2 manuals.

For Your Information

To play the audio files in the MMPM/2 environment:

When you play the wave audio files, select the **Digital Audio** icon.

When you play the MIDI sequencer files, select the **MIDI** icon.

Using the Mwave DSP Audio Features

DOS

For DOS

The Mwave feature supports the audio for DOS games through the *Sound Blaster* support.

To enable Sound Blaster support for DOS games:

Type **MWGAMES ON** at the DOS prompt; then press **Enter**.

To disable the Sound Blaster support for DOS games:

Type **MWGAMES OFF** at the DOS prompt; then press **Enter**.

Note:

If you have exited Windows and returned to DOS, you might have to run **MWGAMES ON** again to enable the Sound Blaster support.

Creating a Boot Diskette

To have enough memory for your games, you should make a *boot diskette* before starting the DOS games. To make a boot diskette, do the following:

1. Turn on the computer and start DOS.
2. Insert a blank diskette into the diskette drive.
3. Type **MAKEBOOT** at the DOS prompt; then press **Enter**.

A boot diskette has started to be created. Before starting your games, restart your computer with this boot diskette inserted into the diskette drive.

Some sample files, such as CONFIG.SYS file, will be created on the boot diskette. You might need to modify these files by referring to the manuals that came with your game.

Default Values for DOS Games Audio

Most games automatically determine the I/O address, interrupt level (IRQ), and DMA channel settings for the audio for DOS games. If the game asks for this information, specify the default settings of the Sound Blaster as follows:

I/O Address	220
Interrupt Level (IRQ)	5
DMA Channel	1

If you need to change these settings, do the following:

For DOS, use the **PS2** command (**PS2 SB** command).

For the DOS session of OS/2 and Windows, select **DSP** from the ThinkPad Setup window.



PS2 command:
Page 41.



ThinkPad Features setup
menu:
Page 39.

Using the Mwave DSP Audio Features



For Windows or WIN-OS/2

Note:
To use the Mwave audio features in WIN-OS/2, install the Mwave DSP support software for Windows in the full-screen WIN-OS/2 session.

 To install Mwave support software:
Page 195.

To use Mwave audio functions in Windows or WIN-OS/2, double-click on the **Mwave ThinkPad** icon in the Windows Program Manager.

A window similar to the following appears:

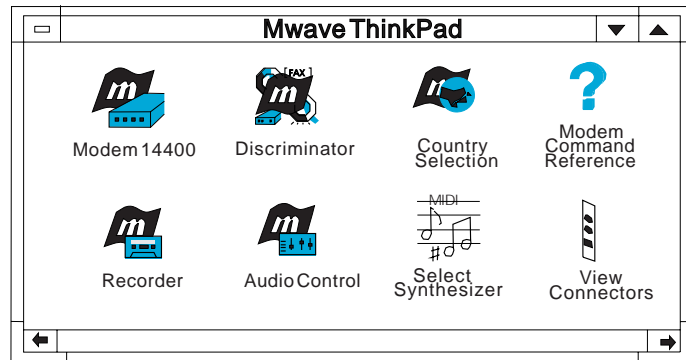

Recorder

Record and Playback the Wave Audio Files

When you double-click on the **Recorder** icon, the following window appears:

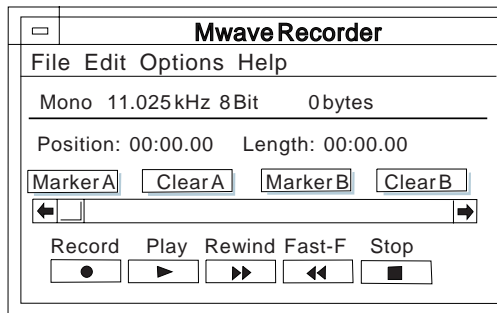

This window allows you to record and playback the wave audio files.

Note:
You can use an electric condenser microphone (with battery) for sound recording.

This window is similar to the *Windows Sound Recorder*, which provides wave recording and playback functions; however, this window has additional features for controlling the record quality and file size.

Using the Mwave DSP Audio Features



Audio Control

When you double-click on the **Audio Control** icon, the following window appears:

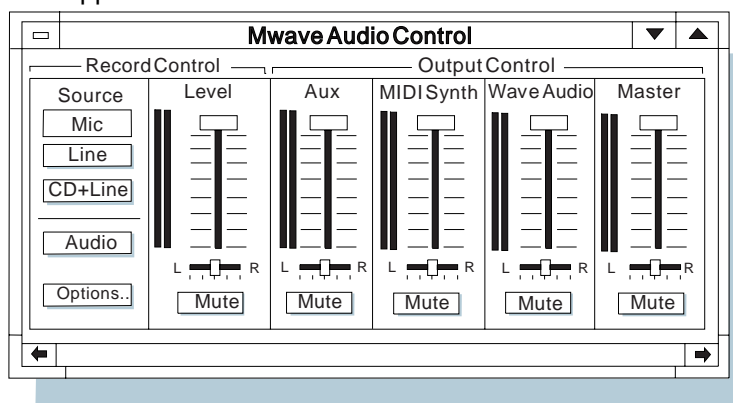

This window allows you to control the audio volume as follows:

Record control

This section enables you to select which source you want to use, adjust the record level, monitor the input signal, and select an options menu for additional control.

Output control

This section allows you to adjust the balance and sound levels, and control the mute. And, it can be considered a stereo amplifier with three input signals, controls to mix the input signals, and a volume control for the output.

Audio button

This is used to enable the following audio features:

- Audio/Image Synch in the Options menu
- Aux Source

Important

Disable the **Audio** button before you use a speaker phone application.

If the **Audio** button is enabled, the speaker phone application does not operate correctly and displays an error message on the screen.

Using the Mwave DSP Audio Features

Note:

Selecting the **Audio/Image Synch** on the *Options* menu improves the response speed; however, the increase in DSP resources can affect your ability to concurrently use some Mwave applications.

Note:

If you enable **Aux Source**, the computer will consume more battery power. Disable **Aux Source** when you do not use it.

Note:

When you play the MIDI files in the WIN-OS/2 environment, see "Considerations for the WIN-OS/2 Environment" on page 83.

Options button

- **Audio Mode**
If you are using some applications with sounds and animation (for example, games or screen saver programs), try this option to make the application work more quickly.
- **Aux Source**
Select the source you want to listen to by the computer speaker or headphones.

Playing the MIDI Sequencer Files

To play the MIDI sequencer files in Windows, use the Windows Media Player as follows:

- 1** Start Windows; then open the **Accessories** group.
- 2** Double-click on the **Media Player** icon.
- 3** When the Media Player window appears, select the **Device** on the menu bar; then select **MIDI Sequencer...** from the pull-down menu.

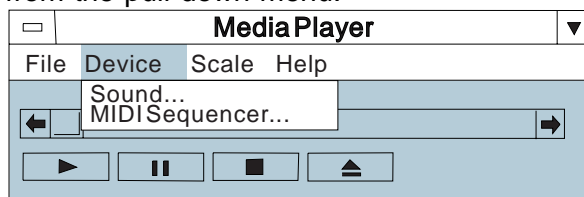

- 4** Click on the **File** on the menu bar; then select **Open...** from the pull-down menu.
- 5** Highlight your favorite MIDI file with your pointing device; then click on **OK**.
- 6** To begin playing the MIDI file, click on the **Play** (▶) button.

Using the Mwave DSP Audio Features

Note:

When you use wave audio and *Aux* at the same time, select 24 voices (the default value).

Select Synthesizer



When you select the MIDI icon in the *Mwave ThinkPad* window, you can change the number of voices supported by the MIDI synthesizer.

Note:

Volume of the Sound Blaster sound can be controlled by using the following key combinations: **Ctrl+Alt+U** (volume up) and **Ctrl+Alt+D** (volume down).

Sound Blaster support

For Windows, Mwave supports the Sound Blaster support in a DOS session. It is not necessary to type **MWGAMES ON** to enable the support, this is done automatically. Simply open a DOS session and start the game.

Considerations for the WIN-OS/2 Environment

Note:

When you use the WIN-OS/2 environment, see "For Windows or WIN-OS/2" on page 80.

The following are considerations when playing MIDI files in the WIN-OS/2 environment.

To play MIDI files in the WIN-OS/2 environment *from the OS/2 Desktop*, the **Audio Mode** in the *Mwave Audio Options* menu must be set to **Normal** (not **Audio/Image Synch**).

The MWS.EXE program must be running in the same session as the program that runs the MIDI file. If you use multiple WIN-OS/2 sessions, MWS.EXE must be started in each session. To run MWS.EXE, migrate it to the OS/2 Desktop and start it before starting the MIDI application programs. To migrate MWS.EXE to the OS/2 Desktop, refer to the OS/2 manuals.

Using the Mwave DSP Telephony Features

Using the Telephony Function

In some countries, the Mwave telephony functions are available after the DAA/Telephony Kit option is installed. To install DAA/Telephony Kit on the computer, see "Installing the DAA/Telephony Kit" on page 155 and the documentation that came with the option.

Connecting the Telephone Cable

To use the telephony functions, you need to connect a telephone line to your computer.



To avoid shock hazard, do not connect the telephone cable to or disconnect it from the telephone outlet on the wall during electrical storms.

Note:

If you use both the computer and a telephone with one telephone cable, use the wallet supplied with your computer.

Note:

When you use the DAA/Telephony Kit (available as an option), see page 158.

When your computer has a modem/fax port with a square receptacle, connect the connector 1 of the ferrite-core end of the telephone cable to the modem/fax port; then connect the other end 2 to the telephone outlet on the wall.

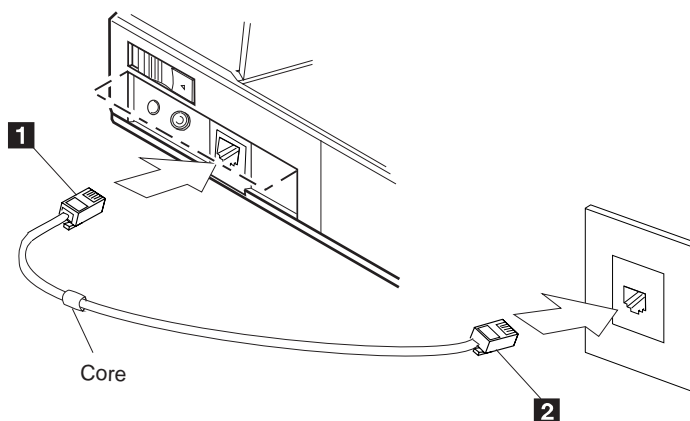

Using the Mwave DSP Telephony Features

Using the Mwave Modem

The Mwave data modem can be used with the Windows terminal emulator to access your favorite bulletin board or online system (PRODIGY**, CompuServe**, America Online**, or other online systems).

Important

Before you start the communication by using your communication program, start the Mwave modem.



For OS/2 and Windows

To start the Mwave modem, do the following:

1 Select the following according to your operating system:

For OS/2, open the **Mwave for OS/2** folder on the OS/2 Desktop.

For Windows, open the **Mwave ThinkPad** window.

The following screen appears:

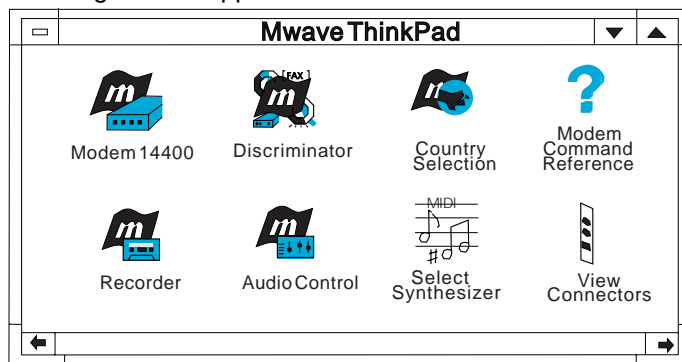

Note:

The screen might be different from the actual one.

Using the Mwave DSP Telephony Features

2 Double-click on the **Modem 14400** icon.

The Mwave modem starts automatically, and the following modem window appears:

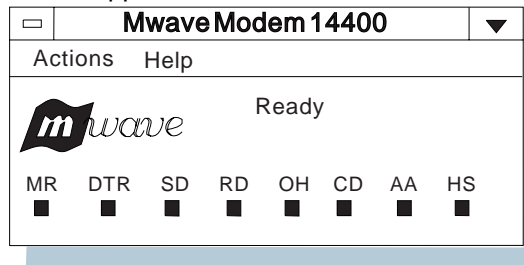

3 Start your communication program.

Stopping the Modem:

When you finish using the communication programs, turn off the modem to free the Mwave DSP resources for other functions. To turn off the modem, do the following:

- 1 If the modem window is minimized, double-click on the icon to maximize it.
- 2 Select **Close** from the window pull-down menu.

DOS

For DOS

To start the Mwave modem, do the following:

Type **MWMODEM ON** at the DOS prompt; then press **Enter**.

Stopping the Modem:

When you finish using the communication programs, turn off the modem to free the Mwave DSP resources for other functions. To turn off the modem:

Type **MWMODEM OFF** at the DOS prompt; then press **Enter**.

Using the Mwave DSP Telephony Features



Mwave Data Modem

The Mwave telephony features support direct attachment to the public switched telephone network. The Mwave data modem supports the standard COM port interface and can be used with the communication application programs that use the Hayes** AT command set.

The Mwave data modem provides the following features:

- Standard asynchronous COM port interface (NS16550A UART compatible) operation

- Bell**–103/212A, CCITT–V.21/V.22, V.22bis protocols with data from 50 to 2400 bps

- CCITT–V.32 protocols with data rates of 4800, 9600 uncoded, and 9600 bps Trellis coded (optional)

- CCITT–V.32bis protocols with data rates of 4800, 7200, 9600, 12 000, and 14 400 bps (optional)

- Hayes AT command set compatibility

- Call progress monitor

- Automatic dialing

- Dual-tone modulation frequency (DTMF) and Pulse dialing

- Asynchronous error-recovery protocol

- Error correction via MicroCom** Network Protocol (MNP**) classes 1–4

- MNP class 5 for up to 2x data compression

- Functional upgrades via software

- CCITT V.42bis for up to 4x data compression

Using the Mwave DSP Telephony Features



Country Selection

Using the Country Selection

Important

Each country has restrictions to communicate when using telephone lines. Use this window whenever you travel to other countries.

Note:

In some countries, the Mwave telephony functions are available after the DAA/Telephony Kit option is installed.

The **Country Selection** window allows you to change the country name currently supported by the Mwave telephony features. When you travel to other countries and use the Mwave telephony function, you need to change the country name from the country list in this window.



Discriminator

Mwave Call Discriminator

The Mwave Call Discriminator provides voice and fax discrimination by monitoring incoming calls for fax signal characteristics. This feature automatically starts a fax, speaker phone, or answering machine application programs.

Using the Mwave DSP Telephony Features

Mwave Fax Modem

The Mwave telephony features offer you the following fax functions:

- Call progress monitor

- Automatic-dialing feature

- Support for a Windows MCI** FAX application interface

- Use of direct memory access (DMA) instead of a COM port to increase performance

- DTMF and pulse dialing

- G3 transfers

- T.4/T.30 operations

- V.27ter — 2400/4800 bps send/receive

- V.29 — 7200/9600 bps send/receive

- V.17 — 14400/14400 bps send/receive

Using the Mwave DSP Telephony Features

Mwave Telephone Answering Machine

Note:

When you use the telephone answering machine function, refer to the manual that came with the application program package.

The Mwave telephony features allow you to use the computer as a telephone answering machine as follows:

- Record greetings and messages through the microphone
- Play back greetings and messages through the speaker or headphones
- Play back greetings and messages to a remote telephone with password
- Use a full-duplex speaker phone with the microphone and speaker
- Record multiple greetings
- Log both incoming and outgoing phone calls
- Start recording your greeting after being alerted by a beep
- Alert your caller with a beep to start recording a message
- Place the phone on or off hook and dial phone numbers
- Redial from the message log and from the keyboard
- Use both tone (DTMF) and pulse dialing from the keyboard
- Maintain a log of incoming and outgoing phone calls and messages
- Use voice compression to minimize disk space for stored greetings and messages
- Use a Windows MCI Telephony application program interface
- Use a high-performance DMA interface
- Speed up or slow down played messages without affecting their pitch (TDHS)
- Detect DTMF digits received from the phone line

Chapter 4. Using Battery Power

This chapter provides information about battery-pack operations.

Operating Time with the Battery Pack	92
Charging the Battery Pack	92
Charging with the AC Adapter	93
Charging with the Travel Quick Charger	94
Replacing the Battery Pack	95
Monitoring the Battery-Power Status	96
Using the Battery-Power Status Indicator	96
Low-Battery Condition	97
Using the Fuel-Gauge Program	98
Fuel-Gauge Program for OS/2 and Windows	99
Discharging the Battery Pack for OS/2 and Windows	100
Fuel-Gauge Program for DOS	101
Discharging the Battery Pack for DOS	102
Preserving Battery-Pack Life	103
Maximizing Battery-Powered Operation	104
Using Advanced Power Management	104
Decreasing LCD Brightness	105
Using Power-Saving Modes	106
Using Power-Saving Options	107

Battery-Powered Operation

Operating Time with the Battery Pack

The battery pack is an internal power source for the computer.

Note:

* The operating time depends on the options used with the computer, the frequency of key input, applications, and the configuration of the system, so it might be shorter or longer than the stated time.

The following tables show the operating times of the computer with a fully charged battery pack.

When you use the lithium ion battery pack:

Model	Battery Operating Time
755CX SVGA model	3.0 — 9.0 hours *
755CX VGA model	3.2 — 10.0 hours *

When you use the NiMH battery pack:

Model	Battery Operating Time
755CX SVGA model	2.4 — 7.0 hours *
755CX VGA model	2.6 — 8.0 hours *

Charging the Battery Pack

Note:



While you operate your computer, the NiMH battery pack cannot be charged with the optional Car Battery Adapter.

You can charge the battery pack with either the AC Adapter or the *Travel Quick Charger* (available as an option). You must charge the battery pack when any of the following conditions exists:

You are setting up your computer.

A new battery pack was purchased.

The battery status indicator  (orange) stays on.

The battery status indicator  (orange) blinks for less than 1 minute; then the suspend mode indicator  turns on.

Charging with the AC Adapter

The following procedure describes how to recharge the battery pack with the AC Adapter when the computer is turned off.

Note:
Make sure the locking lever for the hard disk drive is unlocked.

Note:
When you use the NiMH battery pack, make sure the storage switch is set to the on position (|).

 Storage switch position on the NiMH battery pack:
Page 21.

Notes:
When you charge the lithium ion battery pack, its temperature must be at least 10°C (50°F).



When the AC Adapter is connected, and the remaining power of the installed battery pack is less than a certain amount, discharging and then charging of the battery pack starts automatically.

1 Turn off the computer and open the keyboard.

2 Install the new or discharged battery pack into the computer.

3 Connect the AC Adapter to the computer.

The system-status indicators show the following:

Indicator	Color	Meaning
Battery Charging 	On (green)	The battery pack is being charged. This indicator turns off when the battery is fully charged.
	Blinking (green)	The battery pack is being discharged before charged.
Battery Power Status 	On (yellow)	The battery pack is being charged.
Other indicators	Off (blank)	—

Battery-Powered Operation

The following tables show the approximate charging times for the battery pack.

When you use the lithium ion battery pack:

Conditions	Charging Time
Operational charging	2.0–2.5 hours
Power-off charging	1.5–2.0 hours
Suspend-mode charging	1.5–2.0 hours

When you use the NiMH battery pack:

Conditions	Charging Time
Operational charging	1.7 hours
Power-off charging	1.2 hours
Suspend-mode charging	1.2 hours

 To discharge the battery:
Page 98.

If the NiMH battery pack is new or has not been used for a long period of time, it will not reach full charge with only a single charging. You must discharge and recharge it from three to six times to maximize battery operating time.

Charging with the Travel Quick Charger

You can charge the battery pack with the Travel Quick Charger (available as an option). For the charging procedure, refer to the instructions supplied with the Travel Quick Charger.

Replacing the Battery Pack

Warning:

If you are using PC Cards, either connect the AC Adapter, or stop the PC Card application and remove the PC Cards before doing these steps.

Note:

Make sure the locking lever for the hard disk drive is unlocked.

A spare battery pack is available as an option. Replace the current battery pack when its power becomes low.

The battery pack can be replaced with computer power on or off. To replace the battery pack without turning off the computer, do the following:

- 1** Open the LCD; then open the keyboard. The computer automatically enters suspend mode and:

One beep is heard.

The suspend indicator  blinks; then glows steadily.

- 2** When the computer has entered suspend mode, pull the battery pack toward the front of the computer; then remove it.

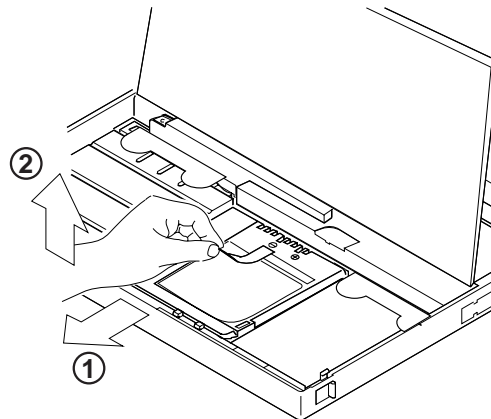

- 3** Quickly install a fully charged battery pack.

- 4** Close the keyboard.

The computer resumes normal operation.

Note:

If the computer does not resume normal operation, press the **Fn** key.

Using the Battery-Power Status Indicator

Monitoring the Battery-Power Status

You can determine the battery condition through the battery-power status indicator and the Fuel-Gauge program.

Using the Battery-Power Status Indicator

 Fuel-Gauge program:
Page 98.

Compare the battery-power status indicator  with the status in the following table to determine the battery condition.

Status	Condition	Action Required
Green	Fully charged.	Continue your work.
Yellow	Usable.	
Orange	Some power remains. You will hear three beeps when the indicator turns orange.	The AC Adapter should be connected to the computer to charge the battery pack.
Blinking orange	Almost discharged (low-battery). See "Low-Battery Condition" on page 97.	Within 1 minute, either: Connect the AC Adapter to the computer; leave the battery pack installed, or Replace the battery pack with a fully charged spare (see "Replacing the Battery Pack" on page 95).

Using the Battery-Power Status Indicator

Status	Condition	Action Required
Off	<p>The battery pack is not installed.</p> <p>The computer is turned off.</p> <p>The computer is in suspend mode when the AC Adapter is not connected.</p>	<p>You should take the necessary actions when the <i>blinking orange</i> condition occurs, before the computer enters suspend mode because of a low-battery condition.</p> <p>If suspend mode is caused by a low-battery condition, data in memory can be lost. Take either of the following actions immediately:</p> <p>To continue your work with the AC Adapter:</p> <ol style="list-style-type: none">1. Connect the AC Adapter to the computer.2. Press the Fn key. <p>To continue your work with a fully charged battery pack:</p> <ol style="list-style-type: none">1. Connect the AC Adapter to the computer.2. Replace the battery pack with a fully charged one.3. Press the Fn key.4. Disconnect the AC Adapter from the computer.

Low-Battery Condition

Warning:
Do not leave the computer in this condition for an extended period of time. Data in memory will be lost.

When the battery pack is low in power, the computer sounds three consecutive beeps, and the battery-power status indicator starts blinking. The battery pack needs to be charged immediately. You must take the actions described under the “Blinking orange” status on page 96. If the actions are not taken within 1 minute, the computer will enter suspend mode.

Using the Fuel-Gauge Program

Using the Fuel-Gauge Program

Note:

When you install an operating system, you must also install the ThinkPad Features program before you can use the Fuel-Gauge program.



To install the ThinkPad Features program:
Page 180.

The Fuel-Gauge program displays the battery-pack condition on the screen.

The Fuel-Gauge program appears on the screen with the following information about the battery pack:

- Power mode
- Battery status
- Suspend or hibernation options
- Discharge option

Refer to the Fuel-Gauge program instructions that are appropriate for your operating system.

Using the Fuel-Gauge Program



Fuel-Gauge Program for OS/2 and Windows

When you press the **Fn+F2** key combination with OS/2 or Windows, the Fuel-Gauge program appears, as shown in the following illustrations:

Notes:

1. The power source (AC Adapter or battery) and power mode alternately appear when the program is minimized:

Power source

AC AC Adapter
BT Battery

Power mode

HI High Performance
AU Automatic
CU Customized

2. "Duration of Remaining Power" does not appear when the AC Adapter is connected.

When the AC Adapter is connected:

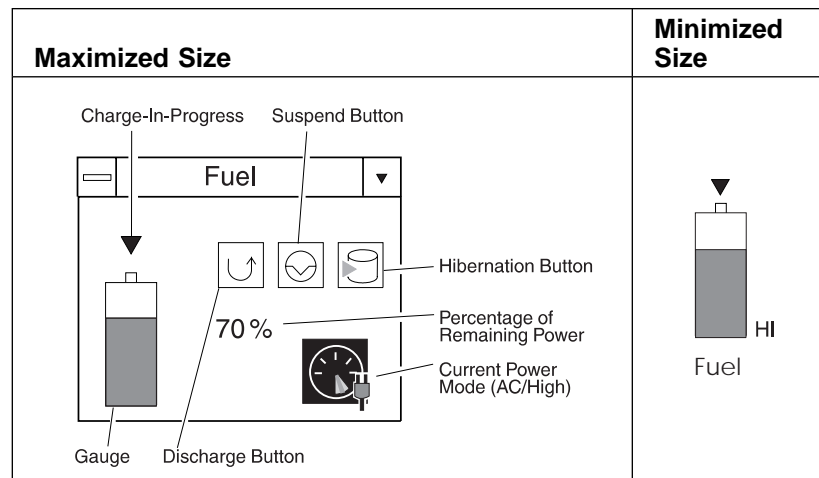

When operated with battery:

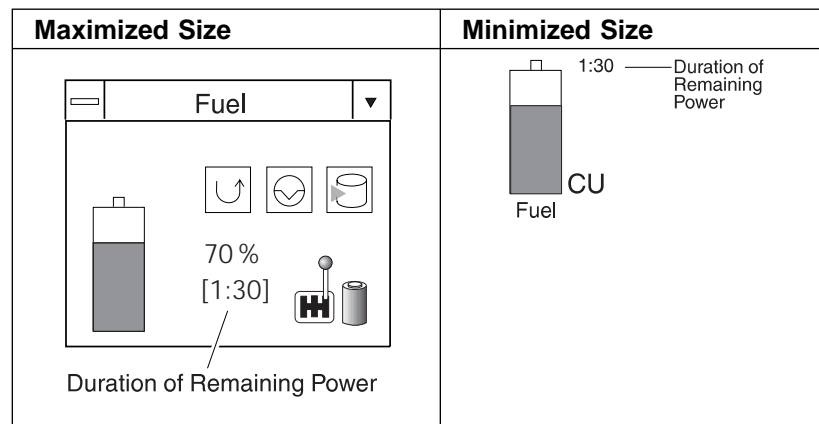



Using the Fuel-Gauge Program

Discharging the Battery Pack for OS/2 and Windows

Note:

The battery charging indicator starts blinking when discharging starts.

When the battery pack needs to be discharged, the computer prompts you with a message. To discharge the battery, connect the AC Adapter to the computer and click on the **Discharge** button () on the Fuel-Gauge program screen. The discharge-in-progress symbol () appears above the gauge symbol, and the **Charge** button () appears in place of the **Discharge** button.

You can use the computer while the battery pack is discharging; however, do not enter suspend mode or turn off the computer until the discharge is complete.

Hints and Tips

If you have to leave the computer while the battery pack is discharging, you can use the power-on password to secure the computer. Close the LCD; then open it and leave the computer at the power-on password prompt while you are away.

When the battery pack is completely discharged, charging starts automatically.

To cancel discharging, click on the **Charge** button ()



Power-on password:
Page 110.

Using the Fuel-Gauge Program

DOS

Fuel-Gauge Program for DOS

When you press the **Fn+F2** key combination with DOS, the Fuel-Gauge program appears at the top-right corner of the screen as shown in the following.

When the AC Adapter is connected:

When the AC Adapter is connected to the computer, the following messages alternately appear:

Power source	AC Charge
- AC Charge: charging battery pack.	
- AC Discharge: discharging battery pack.	
- AC: battery pack is fully charged. (Neither charging nor discharging.)	
Power mode	High
- High (for High Performance mode)	
- Auto (for Automatic mode)	
- Custom (for Customized mode)	
Percentage of charging completed	6 %

Using the Fuel-Gauge Program

When operated with battery:

When the computer is operating with battery power, the following messages alternately appear:

 Power mode:
Page 37.

Power mode	_____
- High (for High Performance mode)	Custom
- Auto (for Automatic mode)	
- Customized (for Customized mode)	
Remaining Power	_____
- Percentage of remaining power	5 % (1 : 4)
- Duration of remaining power	

Discharging the Battery Pack for DOS

Note:
The battery charging indicator starts blinking when discharging starts.

When the AC Adapter is being used and the battery pack needs to be discharged, the computer prompts you with an asterisk (*) next to the fuel-gauge message.

```
_____
AC Charge
```

When you see this message, enter the following command to discharge the battery pack:

```
PS2 DISCHARGE E
```

The battery pack starts to discharge. When the discharge is complete, recharging starts automatically.

To cancel discharging, enter **PS2 DISCHARGE D**.

Preserving Battery-Pack Life

To preserve the life of the battery pack:

Do not charge it until all of its power is used.

Once you have started charging the battery pack, do not use it until it is fully charged.

Turn off the computer whenever it is not in use.

Warning:

When you use the NiMH battery pack, make sure the battery pack power is completely used before you recharge it. Recharging a battery pack that is not completely discharged can shorten battery life.

When you use the NiMH battery pack, discharge the battery pack occasionally by using the Fuel-Gauge program.

Maximizing the Battery-Powered Operation

Maximizing Battery-Powered Operation

To save battery power effectively:

- Use Advanced Power Management (APM)
- Decrease the LCD brightness
- Use power-saving modes
- Use power-saving options

Using Advanced Power Management

Note:

If you have purchased the computer with a preinstalled operating system, the APM is already installed correctly.

The computer has power-management functions built-in. No special power-management drivers have to be installed before you use the computer. However, the computer is able to conserve more power when APM is used.

APM allows you to reduce power consumption when your applications and devices are idle. Each operating system comes with its own APM.



When you use OS/2 with your computer, APM is automatically installed when the installation program detects that your computer has the power-management function.



When you use DOS with your computer, APM is automatically installed when the installation program detects that your computer has the power-management function. To verify that the computer has APM installed correctly, type **power** at the command prompt and press **Enter**. If a screen similar to the following appears, APM is successfully installed.

```
Power Management Status
-----
Setting = ADV: REG
CPU: idle 32% of time.

AC Line Status : OFFLINE

Battery status : High
```

If such a screen does not appear, add the following line to your CONFIG.SYS file, using a text editor:

```
DEVICE=C:\DOS\POWER.EXE
```

Maximizing the Battery-Powered Operation



When you use Windows, do the following to check and install APM for Windows:

1. Start the system. Make sure that the current directory has Windows (usually C:\WINDOWS>).
2. Type **SETUP** at the command prompt and press **Enter**. The following screen appears.

```
Windows Setup
=====

If your computer or network appears on the Hardware Compatibility List
with an asterisk next to it, press F1 before continuing.

System Information
Computer:      MS-DOS System
Display:      WD9 C24 64 x48  256 colors small fonts
Mouse:        Microsoft, or IBM PS/2
```

Note:
If “MS-DOS System with APM” appears for the item “Computer:”, APM is already installed. Press **F3** to exit the setup.

3. Using the **Arrow** keys (↑, ↓), position the highlighted cursor over **MS-DOS** System** and press **Enter**.
4. Position the highlighted cursor over **MS-DOS System with APM** and press **Enter**.
5. Verify that the item **Computer** has changed to **MS-DOS System with APM** on the screen. If not, return to step 3.

```
Windows Setup
=====

If your computer or network appears on the Hardware Compatibility List
with an asterisk next to it, press F1 before continuing.

System Information
Computer:      MS-DOS System with APM
Display:      WD9 C24 64 x48  256 colors small fonts
Mouse:        Microsoft, or IBM PS/2
```

6. Press **Enter** to install APM.
7. Restart the system to make APM effective.

Decreasing LCD Brightness

Adjust the brightness control on the LCD to the lowest level possible that allows you to comfortably view the screen. This is an effective way of conserving battery power.

Maximizing the Battery-Powered Operation

Using Power-Saving Modes

-  For other ways to enter:
- Standby mode:
Page 52.
 - Suspend mode:
Page 53.
- Enter standby mode or suspend mode whenever you are not using the computer. One of the easiest ways to enter the modes is to use the **Fn** key function:
- To enter standby mode:
press and hold **Fn**; then press **F3**.
 - To enter suspend mode:
press and hold **Fn**; then press **F4**.

Maximizing the Battery-Powered Operation

Using Power-Saving Options

Note:

If you have installed an operating system, make sure you also install the ThinkPad Features program.



To install the ThinkPad Features program:
Page 180.

Note:

These power modes allow immediate setting of all power-saving options to their optimum values for each mode.



Power mode:
Page 37.



PS2 command:
Page 41.

The power-saving options specified in each power mode save battery power and make it possible to use the battery pack longer before another recharge is needed. You should select **Automatic** or **Customized** when you travel, because Automatic mode saves power automatically, and you can select values that use the least power by using Customized mode.

To select a power mode:

Press and hold **Fn**; then press **F11**. The power option (High Performance, Automatic, or Customized) changes each time you press this key combination.

Enter **PS2 ?** at the command prompt; then select the appropriate **PS2** command.

Click on the **Power** icon of the *ThinkPad Features program* menu; then select **Automatic** or **Customized**.

If you use Windows or OS/2, press and hold **Fn**; then press **F2**. The fuel-gauge window appears on the screen. Double-click the **power mode** icons.

Maximizing the Battery-Powered Operation

The following figure helps you determine how much power is normally required for each computer feature, and how much is required when the feature is controlled by the power-management function:

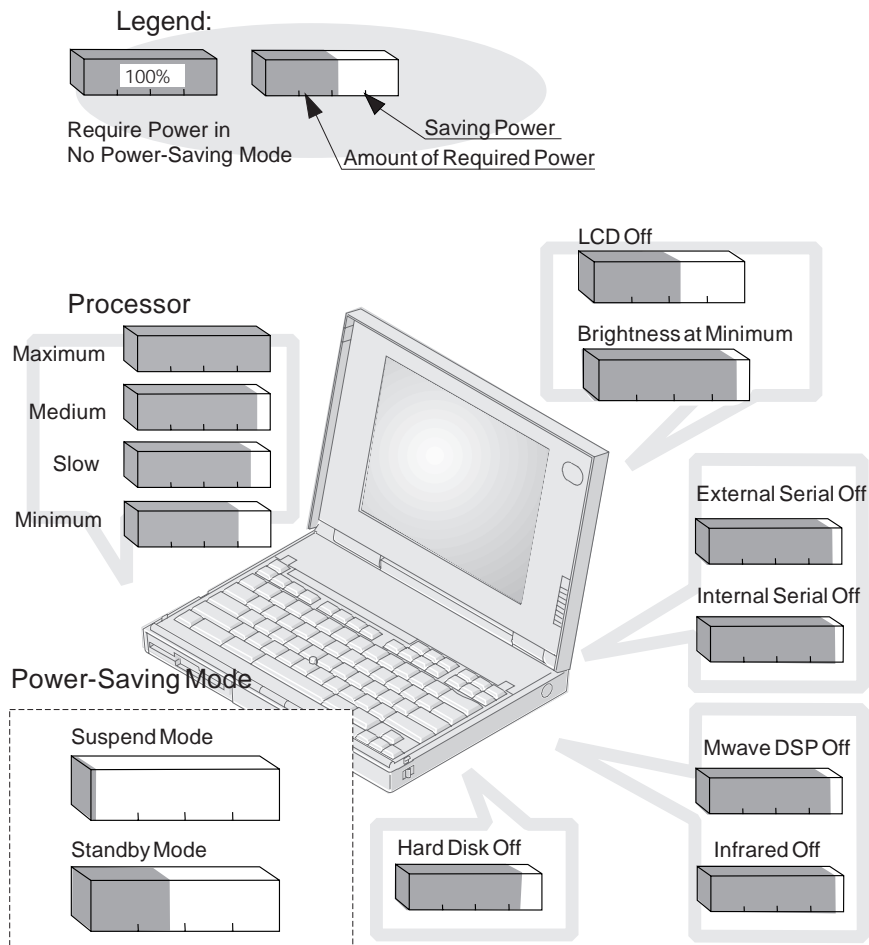

Chapter 5. Protecting Your Computer

This chapter provides information about how to protect your computer and its internal devices.

Using Passwords	110
Power-On Password	110
Setting a Power-On Password	111
Changing a Power-On Password	112
Removing a Power-On Password	113
Hard-Disk Password	114
Setting a Hard-Disk Password	115
Changing a Hard-Disk Password	116
Removing a Hard-Disk Password	117
Supervisor Password	118
Considerations When Using Easy-Setup	118
Setting a Supervisor Password	119
Changing a Supervisor Password	120
Removing a Supervisor Password	121
Using the Hard-Disk and Power-On Passwords	122
Using the Supervisor and Hard-Disk Passwords	122
Using Several Hard Disk Drives with the Supervisor Password	123
Setting a Supervisor Password when Using Several Hard Disk Drives	123
Changing or Removing the Supervisor Password when Using Several Hard Disk Drives	124
Using the Personalization Utility Program	125
Using Locks	130
Using the Lock on the Hard Disk Drive	130
Using the Security Lock	131
Using the PC Card Lock	132
Removing the PC Card Lock	132

Using the Passwords

Using Passwords

There are three types of passwords you can use to protect your computer and the removable hard disk drive:

The *power-on password* protects your computer from being used by unauthorized persons.

The *hard-disk password* protects the data on your removable hard disk drive from being accessed by unauthorized persons.

The *supervisor password* protects the system information in Easy-Setup and your removable hard disk drive from being used by unauthorized persons.

Power-On Password

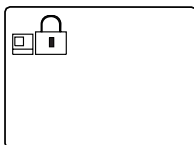

The power-on password helps protect your computer from being used by unauthorized persons. If a power-on password is set, the password prompt (🔒) reminds you to enter the password each time you turn on the computer. The password prompt also appears when you open the LCD or press the **Fn** key to return to normal operation from suspend mode. When the password is entered correctly, **OK** appears.

Note:

Do *not* press the **Spacebar** after you enter the password; this action removes the password.

Note:

If **Default** in the Config menu, **Password**, or **Start up** functions cannot be selected when using Easy-Setup, the supervisor password is set. You must enter the supervisor password instead of the power-on password to use all Easy-Setup functions.

When you enter the password incorrectly, **X** appears. If you fail to enter the correct password after three tries, you must turn the computer off, wait at least 5 seconds and turn it on to try again.

When typing your password, release each key quickly. If you hold a key down too long, the same letter can be entered repeatedly.

If the return to normal operation is caused by the timer or an incoming call through the modem, the password prompt does not appear. Type the correct password on the blank screen.

Setting a Power-On Password

To set power-on password, do the following:



Easy-Setup:
Page 42.

- 1** Start Easy-Setup and select the **Password** icon.
- 2** Select the **Power-On** icon (.
- 3** Type your desired power-on password; then press **Enter**.

You can use any combination of up to seven characters. All alphabets (A to Z and a to z) and numbers (0 to 9) are allowed to use. Uppercase letter (for example, A) and lowercase one (a) are regarded as same letter.

- 4** Type your power-on password again to verify it; then press **Enter**.

Do Not Forget Your Power-On Password

If you forget your power-on password, you cannot reset it. You have to take the computer to IBM authorized reseller or IBM marketing representative have the password canceled. Proof of purchase is required, and an additional charge might be required for the service.

Once you set the password, you cannot change or remove it from Easy-Setup. See “Changing a Power-On Password” on page 112 or “Removing a Power-On Password” on page 113.

Using the Passwords

Changing a Power-On Password

You must change your power-on password at the password prompt. You cannot change it after normal operation is resumed. To change a power-on password, do the following:

Important

Do *not* press **Enter** until you have finished all the steps to change the power-on password.

- 1** Turn off the computer and wait at least 5 seconds; then turn it on.
- 2** When the password prompt () appears, type your *current* power-on password; then press the **Spacebar**.
- 3** Type the *new* password; then press the **Spacebar**.
Use no more than seven characters.
- 4** Type the *new* password again to verify it; then press **Enter**.

Do Not Forget Your Power-On Password

If you forget your power-on password, you cannot reset it. You have to take the computer to IBM authorized reseller or IBM marketing representative to have the password canceled. Proof of purchase is required, and an additional charge might be required for the service.

Using the Passwords

Removing a Power-On Password

You must remove your power-on password at the password prompt. You cannot remove it after normal operation is resumed. To remove a power-on password, do the following:

- 1** Turn off the computer and wait at least 5 seconds; then turn it on.
- 2** When the password prompt (🔒) appears, type your current password; then press the **Spacebar**.
- 3** Press **Enter**.

Hard-Disk Password

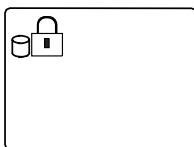

The hard-disk password helps protect the information stored on your removable hard disk drive. When this password is set, the information stored on your hard disk drive cannot be accessed without it.

Note:

Do *not* press the **Spacebar** after you enter the password; this action removes the password.

If a hard-disk password is set, the hard-disk password prompt (🔒) appears:

When you turn on the computer.

When you start entering Easy-Setup (with no supervisor password set).

When the computer returns to normal operation from suspend or hibernation mode.

When the password is entered correctly, **OK** appears. When the hard-disk password is set, activation of the resume function by the timer or an incoming calling suspend mode is disappeared. (To use the resume function with the hard-disk password, see “Using the Hard-Disk and Power-On Passwords” on page 122)

When you enter the password incorrectly, **X** appears. If you fail to enter the correct password after three tries, you must turn the computer off, wait at least 5 seconds, and turn it on to try again.

When typing your password, release each key quickly. If you hold a key down too long, the same letter can be entered repeatedly.

Setting a Hard-Disk Password

To set a hard-disk password, use Easy-Setup and do the following:



To start Easy-Setup:
Page 42.

1 Start Easy-Setup; then select the **Password** icon.

2 Select the **Hard-Disk** icon ()

3 Type your desired hard-disk password; then press **Enter**.

You can use any combination of up to seven characters. All alphabets (A to Z and a to z) and numbers (0 to 9) are allowed to use. Uppercase letter (for example, A) and lowercase one (a) are regarded as same letter.

4 Type your hard-disk password again for verification; then press **Enter**.

Do Not Forget Your Hard-Disk Password

Note the password and keep it in a safe place.

If you forget your hard-disk password, there is no way to reset it or recover data from the hard disk. Neither IBM authorized reseller nor IBM marketing representative can make the hard disk drive usable.

Once you set the password, you cannot change or remove it from Easy-Setup. See “Changing a Hard-Disk Password” on page 116 or “Removing a Hard-Disk Password” on page 117.

Using the Passwords

Changing a Hard-Disk Password

The procedure to change a hard-disk password depends on whether or not it is set the same as the power-on password.

When the hard-disk password is set the same as the power-on password, remove the hard-disk password by following the steps in "Removing a Power-On Password" on page 113. The hard-disk password is removed when you remove the power-on password. After that, reset the hard-disk password. If the power-on password is needed, reset it also.

When the hard-disk password and the power-on password are different, or the power-on password has not been set:

Note:

To make the hard-disk password the *same* as the power-on password, you must change the power-on password, see "Changing a Power-On Password" on page 112.

- 1** Turn off the computer and wait at least 5 seconds; then turn it on.
- 2** If you have set a power-on password, type it; then press **Enter**.
- 3** When the hard-disk password prompt (🔒) appears, type your *current* hard-disk password; then press the **Spacebar**.
- 4** Type the *new* password; then press the **Spacebar**.
Use no more than seven characters.
- 5** Type the *new* password again for verification; then press **Enter**.

Do Not Forget Your Hard-Disk Password

Note the password and keep it in a safe place.

If you forget your hard-disk password, there is no way to reset it or recover data in the hard disk drive. Neither IBM authorized reseller nor IBM marketing representative can make the hard disk drive usable.

Using the Passwords

Removing a Hard-Disk Password

The procedure to remove a hard-disk password depends on whether or not it is set the same as the power-on password.

When the hard-disk password is set the same as the power-on password, remove the hard-disk password by following the steps in “Removing a Power-On Password” on page 113. The hard-disk password is removed when you remove the power-on password. If the power-on password is needed, reset it.

When the hard-disk password and the power-on password are different, or a power-on password is not set:

- 1** Turn off the computer and wait at least 5 seconds; then turn it on.
- 2** If you have set the power-on password, type it; then press **Enter**.
- 3** When the hard-disk password prompt (🔒) appears, type your current password; then press the **Spacebar**.
- 4** Press **Enter**.

Supervisor Password

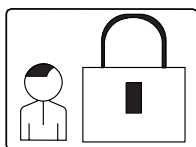

The supervisor password helps protect classified information. It:

- Secures the system information stored in Easy-Setup.

- Prohibits modification to the hardware.

- Stops the computer after a POST error to restrict access to the system information.

- Overrides the power-on password.

If a supervisor password is set, you are prompted with a **power-on** icon (🔒) to enter the supervisor password when entering the Easy-Setup program. When the password is entered correctly, an **OK** appears.

When you enter the password incorrectly, **X** appears. If you fail to enter the correct password after three tries, you must turn the computer off, wait at least 5 seconds, and turn it on to try again.

When typing your password, release each key quickly. If you hold a key down too long, the same letter can be entered repeatedly.

Considerations When Using Easy-Setup

The correct supervisor password must be entered to use all Easy-Setup functions. When accessing Easy-Setup, if **Enter** is pressed without entering the supervisor password or if the power-on password is entered instead, **Default** in the Config menu, **Password**, and **Start up** functions cannot be used. To use these functions, you must enter the correct supervisor password at the password prompt.

Setting a Supervisor Password

To set a supervisor password, do the following:



To start Easy-Setup:
Page 42.

- 1** Start Easy-Setup; then select the **Password** icon.
- 2** Select the **Supervisor** icon ()
- 3** Type your desired supervisor password; then press **Enter**.

You can use any combination of up to seven characters. All alphabets (A to Z and a to z) and numbers (0 to 9) are allowed to use. Uppercase letter (for example, A) and lowercase one (a) are regarded as same letter.

- 4** Type your supervisor password again for verification; then press **Enter**.

Do Not Forget Your Supervisor Password

Note the password and keep it in a safe place.

If you forget your supervisor password, you have to take the computer to IBM authorized reseller or IBM marketing representative to have the system board replaced. Proof of purchase is required, and an additional charge might be required for the service.

There is no way to reset the password or recover data from the hard disk. Neither IBM authorized reseller nor IBM marketing representative can make the hard disk drive usable.

If you are using more than one hard disk drive, see page 123.

Using the Passwords

Changing a Supervisor Password

Do the following to change your supervisor password:

- 1** Turn off the computer and wait at least 5 seconds; then turn it on.
- 2** Start Easy-Setup. Type your *current* supervisor password at the power-on prompt (🔒); then press **Enter**.
- 3** Select the **Password** icon from the *Easy-Setup* menu.
- 4** Select the **Supervisor** icon; then type your *current* supervisor password and press the **Spacebar**.
A window appears to enter the new password.
- 5** Type the *new* password; then press **Enter**.
- 6** Type the *new* password again for verification; then press **Enter**.

Do Not Forget Your Supervisor Password

Note the password and keep it in a safe place.

If you forget your supervisor password, you have to take the computer to IBM authorized reseller or IBM marketing representative to have the system board replaced. Proof of purchase is required, and an additional charge might be required for the service.

There is no way to reset the password or recover data from the hard disk. Neither IBM authorized reseller nor IBM marketing representative can make the hard disk drive usable.

If you are using more than one hard disk drive, see page 124.

 To start Easy-Setup:
Page 42.

Removing a Supervisor Password

Do the following to remove the supervisor password:



To start Easy-Setup:
Page 42.

- 1** Turn off the computer and wait at least 5 seconds; then turn it on.
- 2** Start Easy-Setup. When the power-on prompt () appears, type your current supervisor password; then press **Enter**.
- 3** Select the **Password** icon from the *Easy-Setup* menu.
- 4** Select the **Supervisor** icon; then type your current password and press the **Spacebar**.
- 5** Press **Enter** at the blank box.
- 6** Press **Enter** again at the verification screen.

When the supervisor password is removed, the lock in the **Supervisor** icon is unlocked () and the **Hard-Disk** icon can be selected.

If you are using more than one hard disk drive, see page 124.

Using the Passwords

Using the Hard-Disk and Power-On Passwords

You can use a hard-disk password with a power-on password. When you turn on the computer, you are prompted to enter first the power-on password and then the hard-disk password.

The hard-disk password can be the same as the power-on password. If both passwords are the same:

You are prompted only once with the power-on password prompt when the computer is turned on. Both passwords are changed or removed at the power-on password prompt.

The resume function caused by the timer or an incoming call can be used. The hard-disk password prompt will not appear when normal operation is activated from the suspend mode by the timer or an incoming call. Enter the hard-disk password at the blank screen. The LCD remains blank until the correct password is entered.

Using the Supervisor and Hard-Disk Passwords

When a supervisor password is set, the same password is automatically set for the hard-disk password. Before setting a supervisor password, make sure that you do not have a hard-disk password set. If you do, removed it.

When you change or remove the supervisor password, the hard-disk password also is changed or removed. Even though a hard-disk password is set by the supervisor password, you are not prompted to enter the hard-disk password when the computer is turned on; you cannot change or remove the hard-disk password set by the supervisor password.

Using Several Hard Disk Drives with the Supervisor Password

Because the supervisor password automatically sets a hard-disk password, you must set a supervisor password for each hard disk drive you are using.

To change or remove a supervisor password when you are using several hard disk drives, you must change or remove the hard-disk password for each hard disk drive.

Setting a Supervisor Password when Using Several Hard Disk Drives

Do the following to set a supervisor password when you are using more than one hard disk drive on your computer:



To set a supervisor password:
Page 119.



To install the hard disk drive:
Page 148.

- 1** Set a supervisor password on your computer.
- 2** Install the hard disk drive in which you want to set the supervisor password.
- 3** Turn on the computer. A 158 error appears.
- 4** Press **Enter**.
- 5** Type your supervisor password at the power-on password prompt and start Easy-Setup.
- 6** Select the **Password** icon.
- 7** Select the **Hard-Disk** icon; then press **Enter**.
The supervisor password sets the hard-disk password on the hard disk drive.
- 8** Turn off the computer. Repeat steps 2 through 8 to set the supervisor password for each hard disk drive.

Using the Passwords

Changing or Removing the Supervisor Password when Using Several Hard Disk Drives

To change or remove the supervisor password when using more than one hard disk drive on your computer, do the following:

 To change the supervisor password:
Page 120.

 To remove the supervisor password:
Page 121.

 To install the hard disk password:
Page 148.

1 Change or remove your supervisor password on your computer.

2 Install the hard disk drive with the old supervisor password set.

3 Turn on the computer. The hard-disk password prompt appears.

4 Do one of the following:

If you removed the supervisor password, type the old supervisor password; then press the **Spacebar**.

If you changed the supervisor password, change the old password on the hard disk drive to the new supervisor password by typing:

old (space) new (space) new

5 Press **Enter**.

6 Turn off the computer. Repeat steps 2 through 5 to change or remove the supervisor password for each hard disk drive.

Using the Personalization Utility Program



You can display personal information, such as your name or address, every time the computer is turned on with a power-on or hard-disk password set. This can help you when you misplace your computer. Because the password is set, your data is secured and cannot be accessed, but the personal information is displayed and identifies the owner of the computer. The Personalization Utilities include the Personalization editor to create your own image to be displayed with the text information you create, and the personalization update utility to store your personal data in the nonvolatile memory of your system.

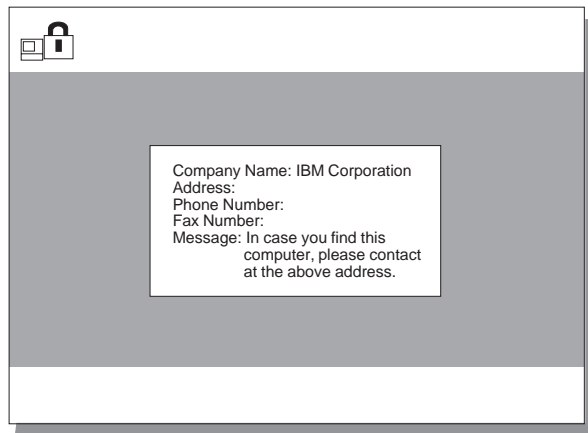

Note:
For the detail of bitmap graphics, see page 269.

To create a personal message for your password-prompt screen, first edit the text and convert it into a bitmap file; then imbed it onto the password-prompt screen by using the Personalization editor. To create your personal data, do the following:

- 1** Turn on the computer and start Windows or OS/2.
- 2** Make a backup copy of the Utility Diskette using your operating system's diskcopy command.
- 3** Insert the backup copy of the Utility Diskette into the diskette drive.

Using the Personalization Utility Program

Notes:

1. Do not use the tab key when typing your information. Use the **Spacebar** instead to insert space between text.
2. You can use any type of font or font size.
3. A sample file (PERSSAMP.WRI) is available on the Utility Diskette.

4 Create your text information using Write and Paintbrush of Windows as follows:

- a) Double-click on the **Write** icon in the Accessories window; then type your personal information.
- b) Double-click on the **Paintbrush** icon in the Accessories window.
- c) Select **Options**; then select **Image Attributes...** from the pull-down menu.

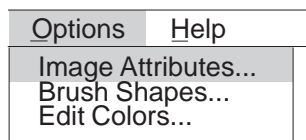

- d) Specify a **Width** of 320 and **Height** of 200; then select **pels** under "Units" and **Black and White** for "Colors." Select **OK**.

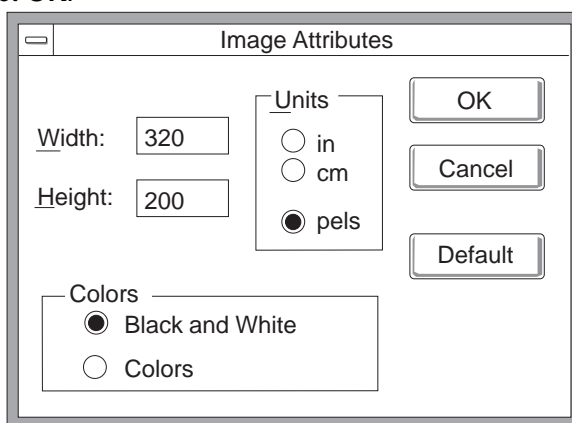

Note:

When closing the Write window, you can save the text for future use.

Note:

A cursor (|) appears indicating where the text will be placed.

- e) Return to the Write window. Save the text to the clipboard by selecting **Edit** and then **Copy**; then return to the Paintbrush window.
- f) Click on the text tool (); then click on the position where the text is to be placed.
- g) Paste the text by selecting **Edit** and then **Paste**, then save it as a bitmap file to the backup copy of the Utility Diskette.
- h) Close Write and Paintbrush.

Using the Personalization Utility Program

5 Create the background of your password-prompt screen as follows:

- a) Select the **Paintbrush** icon.
- b) Select **Options**; then **Image Attributes...** from the pull-down menu.
- c) Specify a **Width** of 160 and **Height** of 100; then select **pels** under “Units” and **Colors** for “Colors.” Select **OK**.

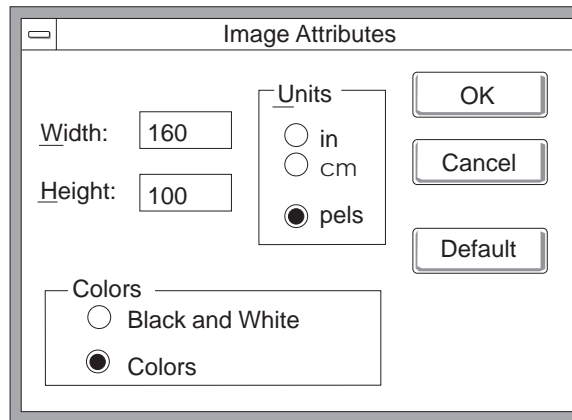

Note:

A sample file (BACKSAMP.BMP) is available on the diskette.

- d) Draw an image or color the background; then save the background as a **16 color bitmap** file to the backup copy of the Utility Diskette.

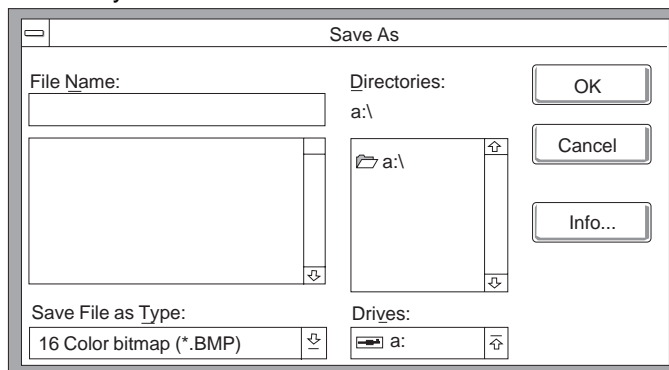

The background will contain 16 copies of your images and the text information in the middle will cover four of the images.

- e) Close Paintbrush.

Using the Personalization Utility Program

6 Save your data using the Personalization editor of ThinkPad Features program as follows:

- a) Select the **Personalization** icon in the ThinkPad Features program.

The following screen appears:

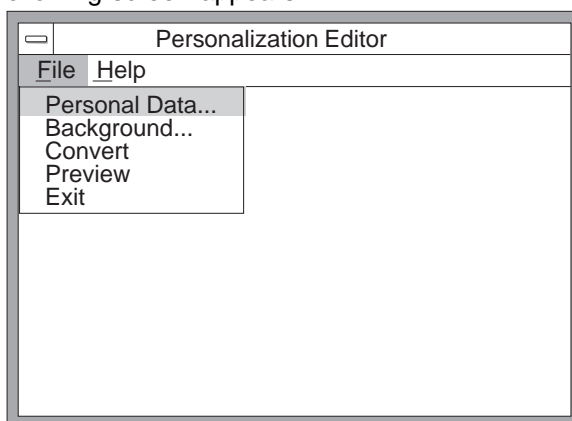

- b) Select **File** from the Personalization Utility window; then select **Personal Data** from the pull-down menu.
- c) Select the bitmap file with the saved text on the backup of the Utility Diskette; then click on **OK** or press **Enter**.
- d) Select **Convert**; then select **Save** from the pull-down menu.
- e) Select **File**; then select **Background** from the pull-down menu.
- f) Select the bitmap file with the saved background on the backup of the Utility Diskette; then click on **OK** or press **Enter**.
- g) To preview of your screen, select **Preview** from the pull-down menu.
To change the screen, repeat the preceding steps.
- h) Exit the Personalization Utility window.

Note:

Press the **Spacebar** to return to the Personalization editor window.

Using the Personalization Utility Program

- 7** Close all applications; then turn off the computer.
- 8** Insert the backup copy of the Utility Diskette into the diskette drive; then turn on the computer.
- 9** Select **Update personalization data**; then follow the instructions on the screen.

Your data will be stored in the nonvolatile memory in the system.

You have completed creating your personalized password-prompt screen. It will appear when the password prompt appears. To create a new screen, follow the same instructions.

Protecting Your Computer and Internal Devices

Using Locks

Note:
You are responsible for the evaluation, selection, and implementation of the locking devices and security features. IBM makes no comments, judgments or warranties about the functions, quality or performance regarding locking devices and security features.

You can protect your computer and its internal devices with locks. In addition, you can attach a chain to prevent the computer from being removed without your permission.

To protect the internal devices under the keyboard and prevent the removal of your computer, you can use the lock on the hard disk drive, or you can purchase a Kensington lock or a compatible lock.

To protect PC Cards, you can use a PC Card lock.

Using the Lock on the Hard Disk Drive

The hard disk drive locking lever, which is located on the bottom of the computer, protects your computer and its internal devices. To use this lock, slide the *locking lever* 1 as shown; then attach a chain or cable to the opening 2 and a stationary object.

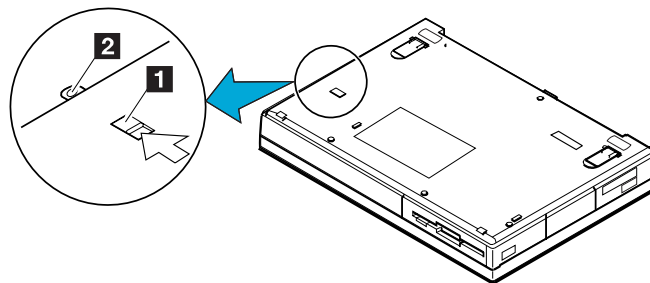

This also prevents the keyboard from opening and secures the internal devices under the keyboard.

Protecting Your Computer and Internal Devices

Using the Security Lock

To prevent your computer from being removed without permission, purchase a Kensington lock or a compatible lock and attach it to the keyhole on the side of the computer; then secure the chain on the lock to a stationary object.

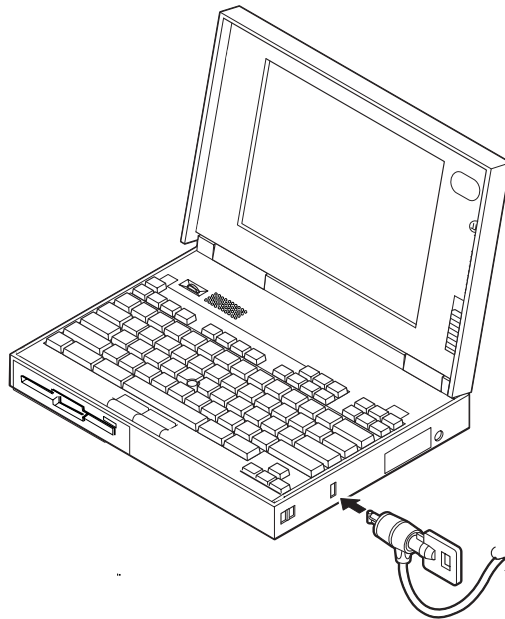

This also prevents the keyboard from opening and secures the internal devices under the keyboard.

Protecting Your Computer and Internal Devices

Using the PC Card Lock

To prevent the PC Cards from being removed from the PCMCIA slots, do the following.

Warning:
Make sure the locking lever for the hard disk drive is unlocked.

- 1** Open the keyboard and insert the PC Card lock **1** as shown.

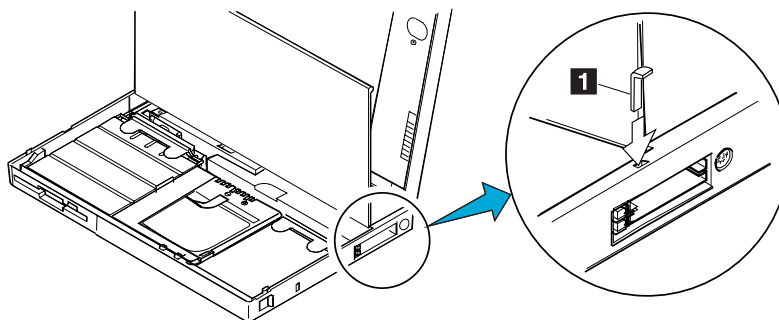

 To lock the keyboard:
Page 130.

- 2** Lock the keyboard.

Removing the PC Card Lock

To remove the PC Card lock, open the keyboard and insert the tip of a pen into the opening **2** from the *inner side* of the computer; then push the lock up.

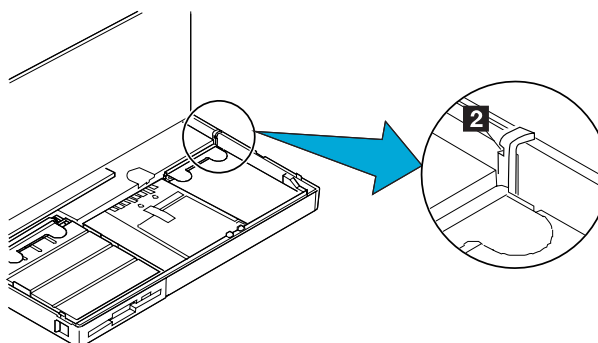

Chapter 6. Installing and Removing Options

This chapter provides information about how to install or remove external or internal devices and IBM options.

Installing and Removing PC Cards	134
Inserting the PC Card	134
Removing the PC Card	136
Increasing Memory Capacity	137
Installing an IC DRAM Card and DIMM	138
Removing the IC DRAM Card and DIMM	143
Replacing the Hard Disk Drive	148
Installing Options in the Diskette Drive Compartment	150
Reinstalling the Option Cover and Front Bezel	153
Installing the DAA/Telephony Kit	155
Attaching an External Numeric Keypad or a Mouse	159
Using the Mouse and Other Pointing Devices	160
Using a Mouse on the IBM ThinkPad Space Saver Keyboard	161
Using the ThinkPad Features Program	161
Using the Device Driver on the Utility Diskette	162
Attaching an External Keyboard	163
Attaching a Printer	164
Attaching an External Display	165
Changing the Display Mode	166
Setting the Monitor Type and the Display Driver	167
Connecting the External Display to the Computer	169
Changing the Screen Resolution or Color Depth	170
Using SVGA Display Drivers	171
Attaching the IBM Dock I or Dock II	172

Installing and Removing PC Cards

Installing and Removing PC Cards

This section explains how to install and remove a PC Card. For information about operating the computer with PC Cards, refer to "Using PC Cards" on page 61.

Note:
When installing an operating system, install the PCMCIA device driver that is on the PCMCIA Features Diskette before using the PC Cards.

 To install the PCMCIA device driver:
Page 183.

Warning:
Do not insert IC DRAM cards into the PCMCIA slots.

Type I and II PC Cards can be inserted into either the upper or lower slot, or in both slots at the same time. The Type III PC Card, however, must be inserted only in the lower slot **2**. You *cannot* use a Type I or II PC Card in the upper slot **1** when a Type III PC Card is used.

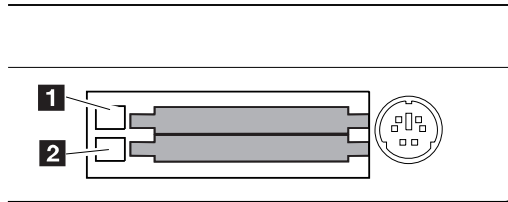

Inserting the PC Card

1 Insert the tip of a ballpoint pen into the end-cut of the blank cover **1**; then remove the cover from the PCMCIA slot.

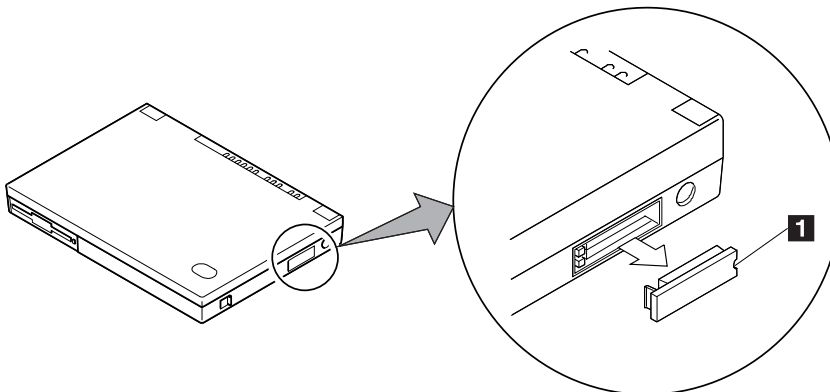

Installing and Removing PC Cards

2 Insert the PC Card into an appropriate slot according to your PC Card type:

If you are using a **Type I** or **Type II** PC Card, insert it into either the upper slot 1 or the lower slot 2 as shown. Then press it firmly into the connector.

If you want to use another PC Card, insert it into the other slot in the same way.

If you are using a **Type III** PC Card, insert the card into the *lower* slot 2 as shown. Then press it firmly into the connector.

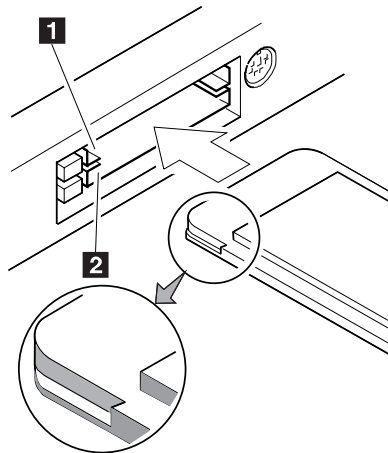

3 Install the cover with the cable opening 1 .

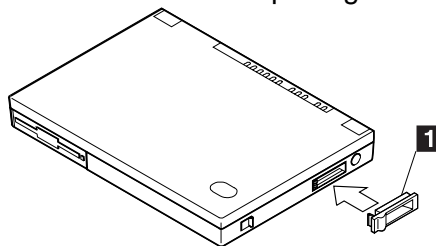

Installing and Removing PC Cards

You have completed the installation of the PC Card. Refer to the following sections:

To use PC Cards, see “Using PC Cards” on page 61.

To use PC Cards with power-saving functions, see:



- “Considerations for Suspend Mode” on page 55.
- “Considerations for Hibernation Mode” on page 60.

To secure your PC Card with a lock, see “Using the PC Card Lock” on page 132.

Removing the PC Card

Warning:
Make sure the PC Card lock is removed.

 To remove PC Card lock:
Page 132.

- 1** Press the PC Card eject button,  or , for the PC Card you want to remove; then remove the PC Card.

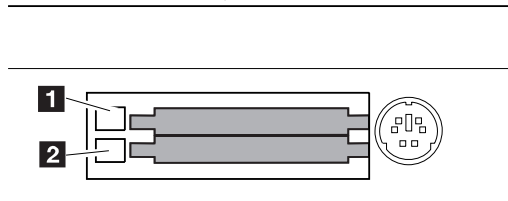

- 2** If you are not going to use the PCMCIA slot, remove the cover with the cable opening; then install a blank cover.

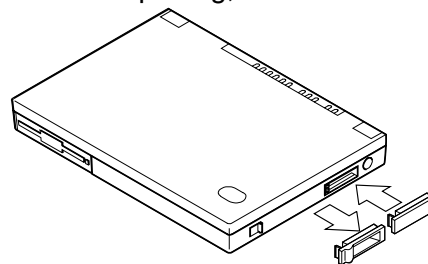

Increasing Memory Capacity

Increasing memory capacity is an effective way to make programs run faster. You can increase the amount of memory in your computer by installing either an *IC DRAM card* or *Memory Modules (DIMMs)*. Because the computer has only one slot for a memory card, you cannot use both an IC DRAM card and DIMMs at the same time.

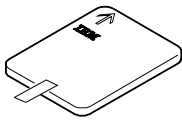

IC DRAM card

The computer has one slot that accepts an IC DRAM card with any of four capacities: 2MB, 4MB, 8MB, and 16MB. Because your computer comes with 8MB of memory, the maximum memory capacity is 24MB if a 16MB IC DRAM card is installed.

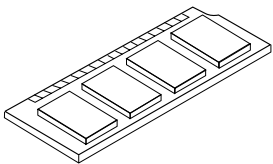

DIMM

You might want to install more memory to maximize the capability of your computer. Instead of using IC DRAM cards, you can install a dual inline memory module adapter (DIMM adapter), with one or two DIMMs, in the same slot you would install the IC DRAM card. The memory capacity can be expanded up to 40MB. The DIMM adapter has two sockets for future expansion. Three different capacities of DIMMs (4MB, 8MB and 16MB) and the DIMM adapter are available as options.

Increasing Memory Capacity

Installing an IC DRAM Card and DIMM

Warning:

Make sure the locking lever for the hard disk drive is unlocked.

Warning:

To avoid damage to the diskette drive, make sure the AC Adapter is disconnected from the computer.

The diskette drive is a very delicate device that needs careful handling. Do not press on, drop, or apply any shock to the diskette drive while it is removed from the computer.

1 Turn off the computer; then disconnect the AC Adapter and all cables from the computer.

2 Open the LCD; then open the keyboard.

3 Make sure there is no diskette in the diskette drive; then lift the diskette drive handle by pulling the plastic tape

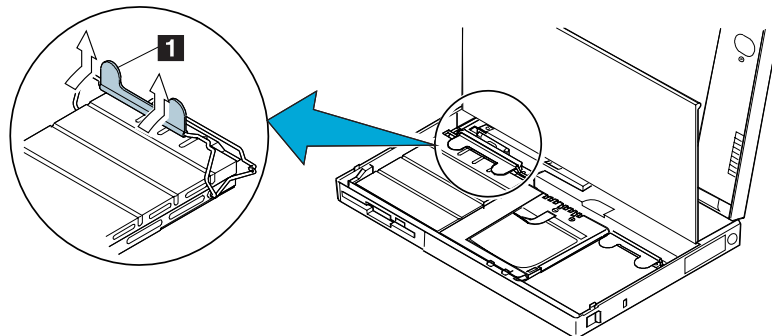

4 Remove the diskette drive.

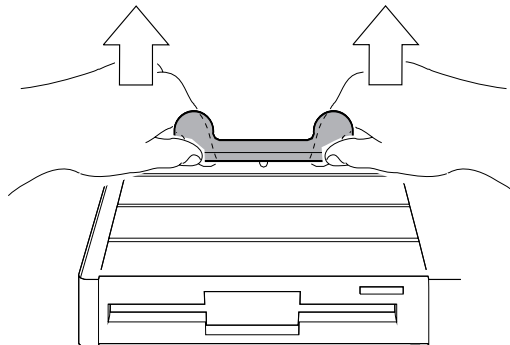

5 Which type of memory are you installing?

IC DRAM card

Go to the next step.

DIMM

Go to step 9 on page 140.

Increasing Memory Capacity

- 6** Place the adhesive strap **1** on the card as shown. This strap is used to remove the card.

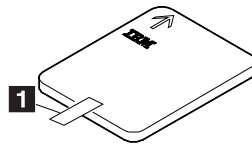

Warning:
Do not insert any PC Card into the connector for the IC DRAM card.

- 7** Insert the IC DRAM card as shown. Press the card firmly into the connector.

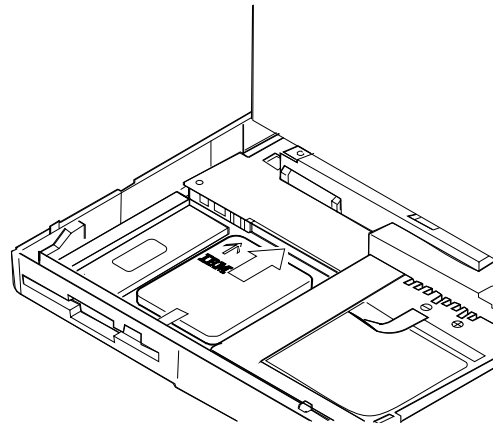

- 8** Go to step 12 on page 142.

Increasing Memory Capacity

Note:

Be sure to save the base plate for future use.

- 9** Pinch the levers **1** on the left side of the base plate **2** and pull the plate slightly toward the front; then raise the rear portion of the base plate and remove it.

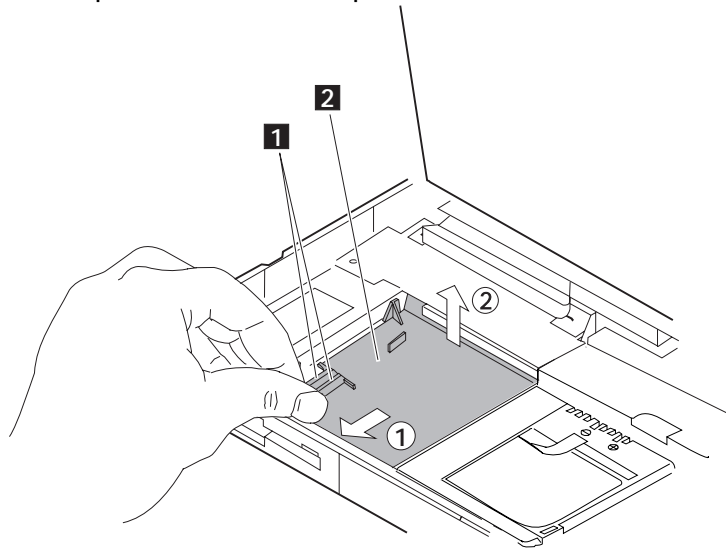

- 10** Insert the DIMM adapter **1** into the connector by pressing on both edges as shown.

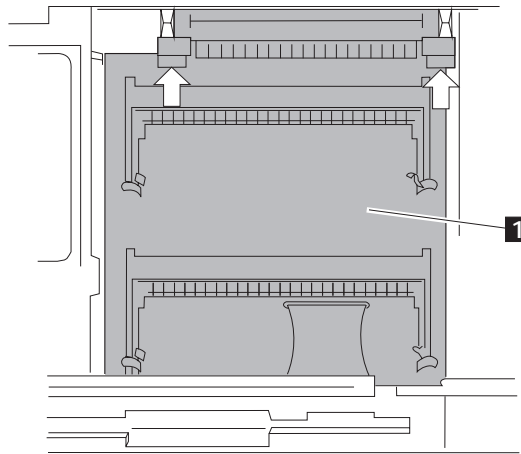

Increasing Memory Capacity

Warning:
To avoid damaging the DIMM, do not touch its contact edge.

11 Insert the DIMM into either of the sockets on the DIMM adapter.

- a) Find the notch 1 on the side of the DIMM.
- b) With the notched end of the DIMM toward the right side of the socket 2, insert the DIMM, at an angle of approximately 35 degrees, into the socket; then press it firmly.
- c) Pivot the DIMM until it snaps into place.

If you have another DIMM to install, insert it into the other socket in the same way.

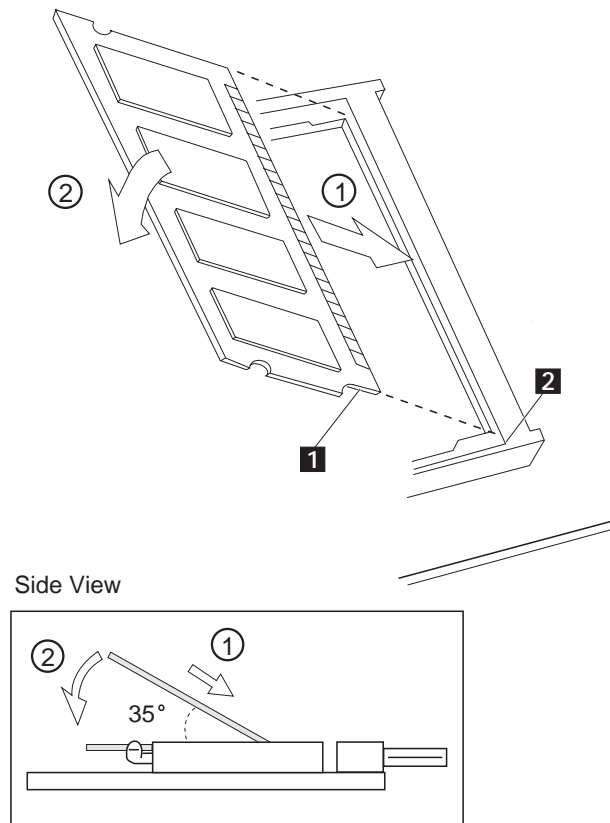

Increasing Memory Capacity

Warning:

The diskette drive is a very delicate device. Do not press on the middle of the diskette drive. Otherwise, the drive head could get damaged.

- 12** Reinstall the diskette drive. Press on the shaded area **1** as shown until the drive snaps into the connector.

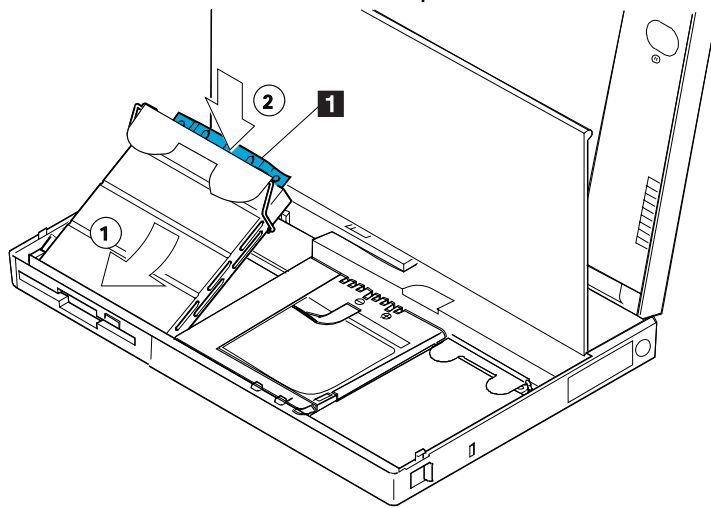

- 13** Close the keyboard and reconnect all cables.

You have completed the installation of the IC DRAM card or DIMMs. If you plan to use the hibernation mode, see “Creating the Hibernation File” on page 59.

Removing the IC DRAM Card and DIMM

Warning:

Make sure the locking lever for the hard disk drive is unlocked.

Warning:

To avoid damage to the diskette drive, make sure the AC Adapter is disconnected from the computer.

The diskette drive is a very delicate device that needs careful handling. Do not press on, drop, or apply any shock to the diskette drive while it is removed from the computer.

1 Turn off the computer; then disconnect the AC Adapter and all cables from the computer.

2 Open the LCD; then open the keyboard.

3 Make sure there is no diskette in the diskette drive; then lift the diskette drive handle by pulling the plastic tape

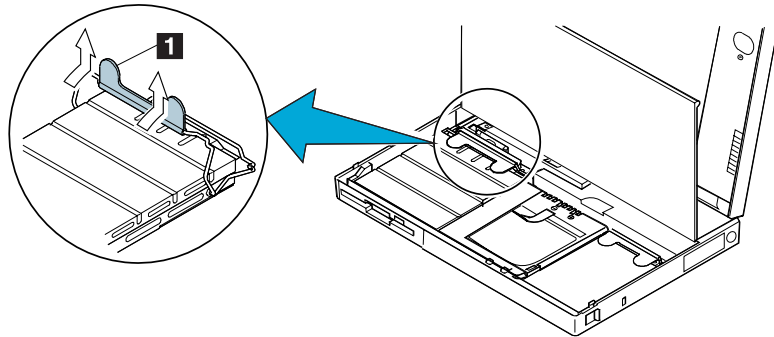

4 Remove the diskette drive.

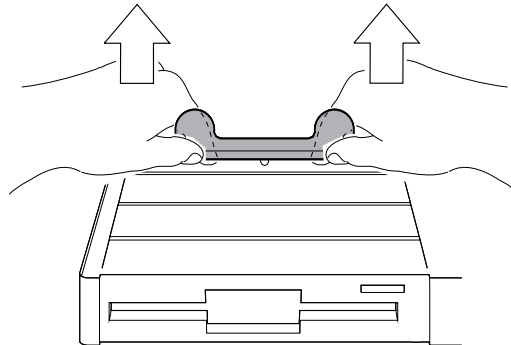

5 Which type of memory are you removing?

IC DRAM card

Go to the next step.

DIMM

Go to step 8 on page 145.

Increasing Memory Capacity

- 6 Remove the IC DRAM card by pulling the adhesive strap 1 .

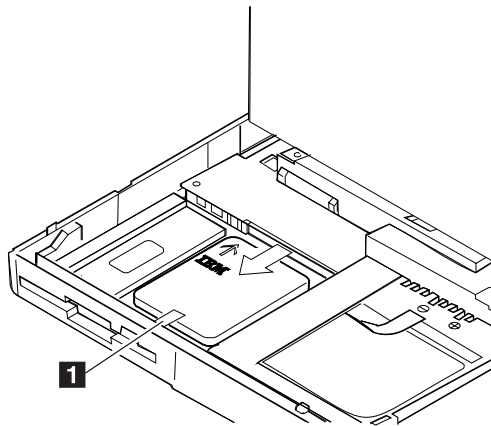

- 7 Go to step 12 on page 147.

Increasing Memory Capacity

Warning:
To avoid damaging the DIMM, do not touch its contact edge.

- 8 Press the locks on both edges of the socket at the same time and remove the DIMM.

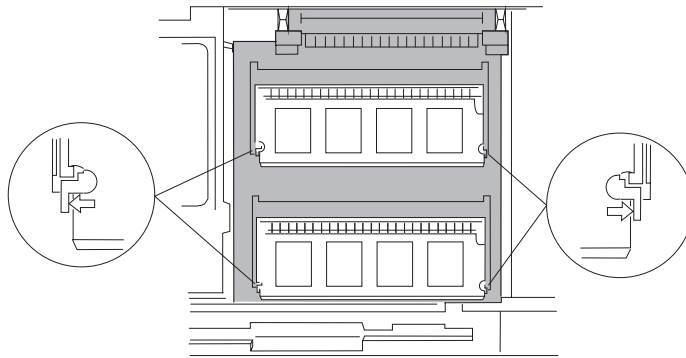

- 9 While holding the strap 1, pull the DIMM adapter 2 toward the front and remove it.

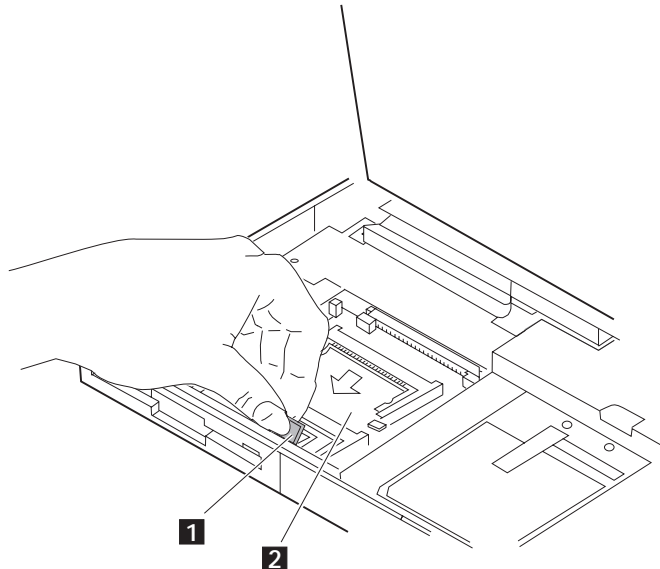

Increasing Memory Capacity

Note:

The base plate should have been removed and stored when you installed the DIMM adapter.

- 10** Pinch the levers **1** on the left side of the base plate **2** and install it as shown.

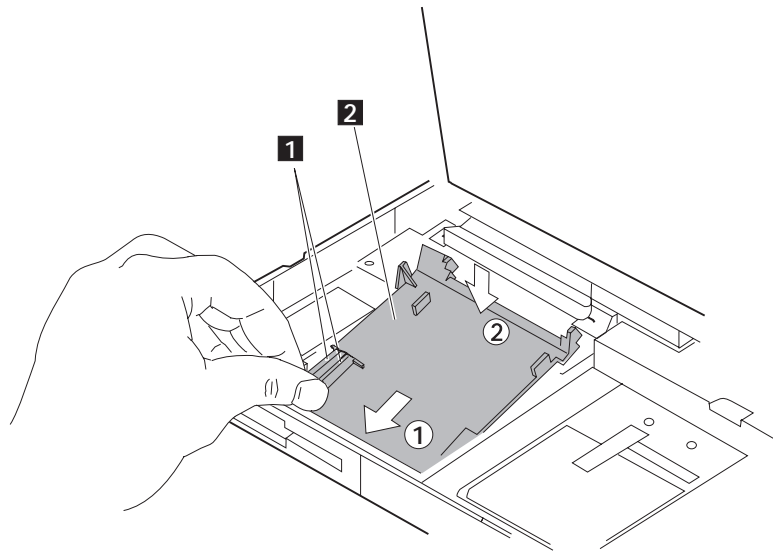

- 11** Push the base plate forward to click it into place.

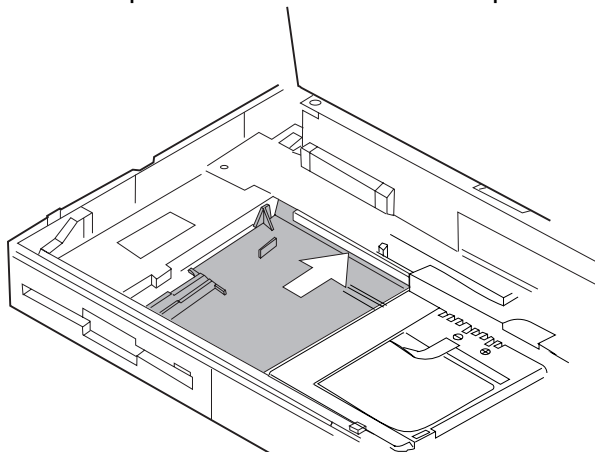

Increasing Memory Capacity

Warning:

The diskette drive is a very delicate device. Do not press on the middle of the diskette drive. Otherwise, the drive head could get damaged.

- 12** Reinstall the diskette drive. Press on the shaded area **1** as shown until the drive snaps into the connector.

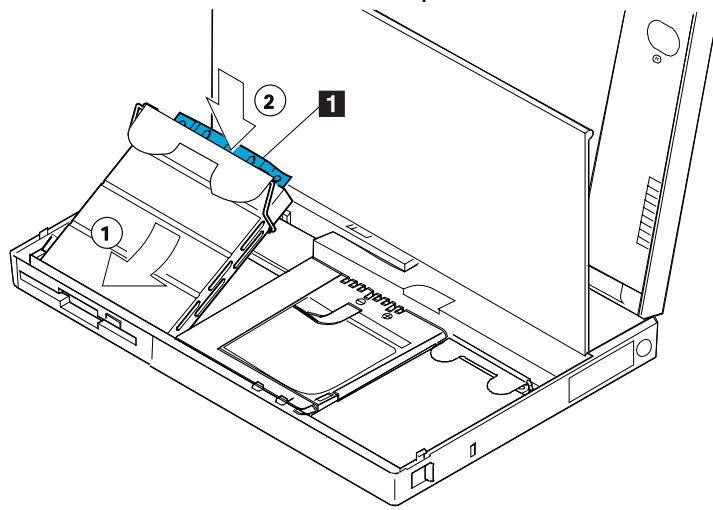

- 13** Close the keyboard and reconnect all cables.

Replacing the Hard Disk Drive

Replacing the Hard Disk Drive

The capacity of the hard disk can be increased by replacing the original hard disk drive with an optional one. This option can be purchased through your IBM authorized reseller or IBM marketing representative.

Warning:
Make sure the locking lever for the hard disk drive is unlocked.

Warning:
The hard disk drive is a very delicate device that needs careful handling. If it falls onto a hard surface, severe damage can occur.

Warning:
The metal area at the bottom of the hard disk drive might become hot, but it is not a defect.

1 Turn off the computer; then disconnect the AC Adapter and all cables from the computer.

2 Open the LCD; then open the keyboard.

3 Lift the hard disk drive handle by pulling the plastic tape ¹.

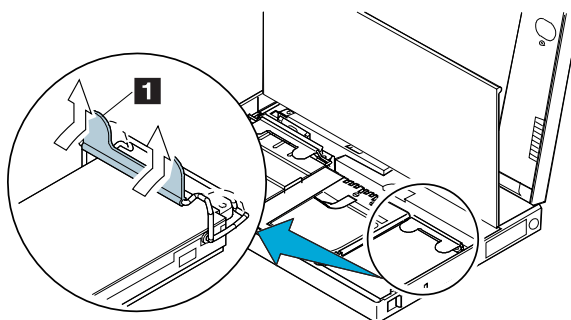

4 Remove the hard disk drive.

Be careful that you hold the drive as it comes out of the compartment. Gently place it on a flat surface. After removing the drive, keep it in the carrying case that contained the replacement drive.

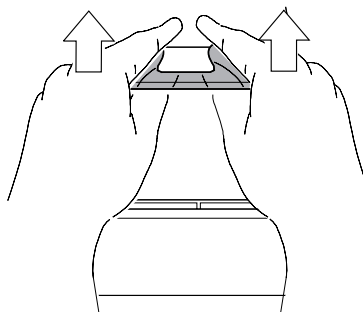

Replacing the Hard Disk Drive

- 5** Insert the replacement drive. Press on the shaded area **1** as shown until the drive snaps into the connector; then close the keyboard.

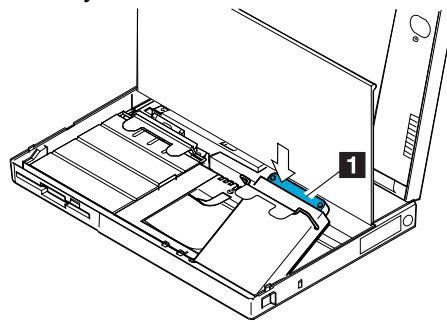

- 6** Connect the AC Adapter to the computer; then turn on the computer.

You have completed the replacement of the hard disk drive. To install your operating system and other necessary software, see "What You Need for Your Computer" on page 174.

Installing Options in the Diskette Drive Compartment

Installing Options in the Diskette Drive Compartment

You might need to remove the option cover and the diskette drive bezel (on the front of the computer) when you install options in the diskette drive compartment. To remove the option cover and bezel, do the following:

Warning:

To prevent damage to the diskette drive, make sure the AC Adapter is disconnected from the computer.

The diskette drive is a very delicate device that needs careful handling. Do not press on, drop, or apply any shock to the diskette drive while it is removed from the computer.

- 1** Turn off the computer; then disconnect the AC Adapter and all cables from the computer.
- 2** Open the LCD; then open the keyboard.
- 3** Make sure that no diskette is in the drive; then lift the diskette drive handle with the plastic tape, and remove the diskette drive.

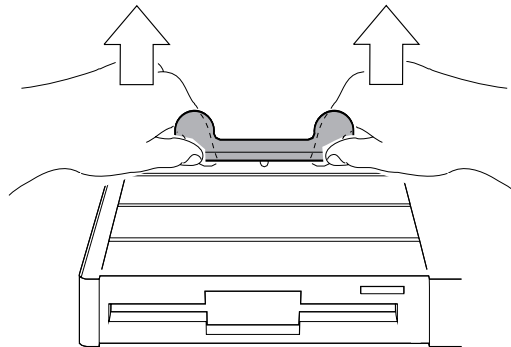

- 4** Insert a coin between the option cover and computer.

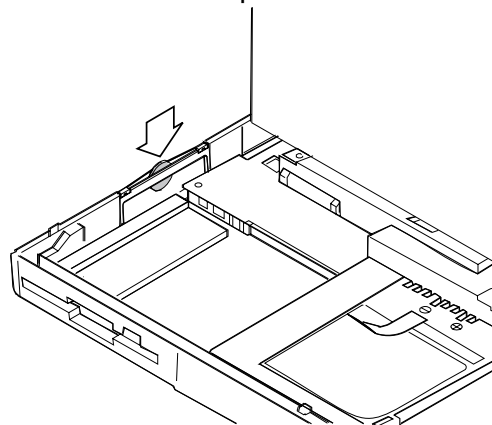

Installing Options in the Diskette Drive Compartment

- 5** Push the option cover from the bottom of the computer and remove it.

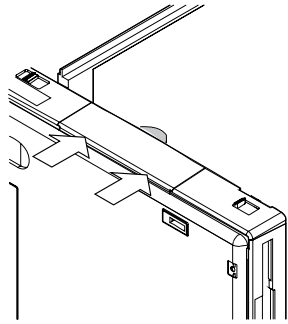

- 6** Insert a coin between the diskette drive bezel and computer.

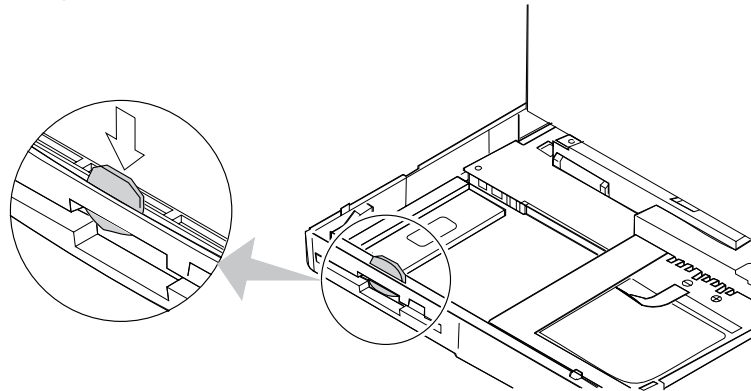

Installing Options in the Diskette Drive Compartment

- 7 Push the bezel from the bottom of the computer and remove it.

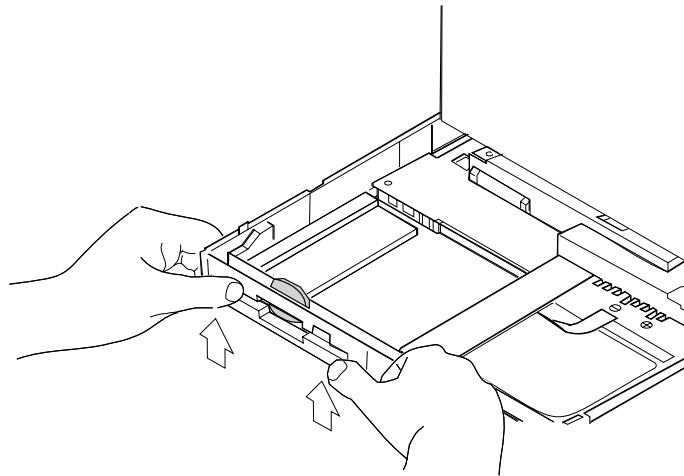

- 8 Refer to the manual that came with the option to install it and its bezel in the compartment.
- 9 Close the keyboard and reconnect all cables.
- 10 If the option in the diskette drive compartment requires power, start the ThinkPad Features program and set the parameter to send power to it.



If you are using OS/2 or Windows,

- 1 Start the ThinkPad Features program.
- 2 Select **Power**; then select **Diskette Drive Compartment** in the *Power for devices* menu.



If you are using DOS, use the **PS2** command at the command prompt.

 **PS2** command:
Page 41.

Installing Options in the Diskette Drive Compartment

Reinstalling the Option Cover and Front Bezel

To reinstall the option cover (on the side of the computer), do the following:

- 1** Insert the upper portion of the option cover into the computer; then insert the lower portion.

The following figure shows the computer as seen from its front side.

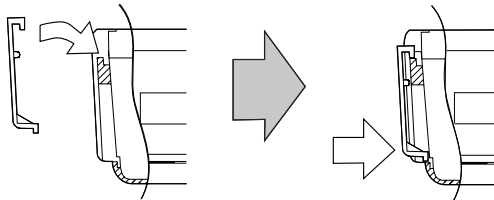

- 2** Push the upper portion of the cover down into the computer until it snaps into place.

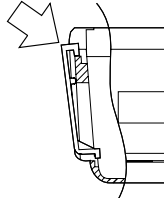

Installing Options in the Diskette Drive Compartment

To reinstall the diskette drive bezel (on the front of the computer), do the following:

Insert the lower portion of the diskette drive bezel into the computer; then insert the upper portion. Push the upper portion of the bezel down into the computer until it snaps into place.

The following figure shows the computer as seen from its side.

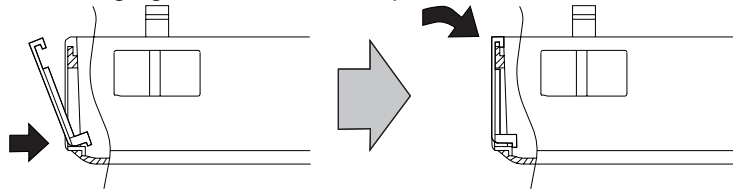

Installing the DAA/Telephony Kit

Note:

In some countries, the Mwave telephony functions are available after the DAA/Telephony Kit option is installed.

If the telephone plug on the left side of your computer is one with a square receptacle, the computer can be used for telephony or modem/fax functions without any changes. However, if a dummy connector plug is attached, you need to install the DAA/Telephony Kit into your computer to use the Mwave telephony functions.

To attach the DAA/Telephony Kit, do the following:

- 1** Turn off the computer; then open the port cover on the left side of the computer.

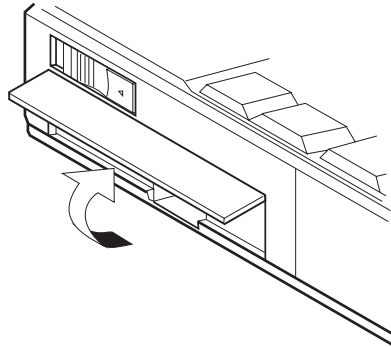

Warning:

Make sure the locking lever for the hard disk drive is unlocked.

- 2** Open the keyboard.

Installing the DAA/Telephony Kit

- 3** Slide the latch **1** to the left-most position and release the dummy plug.

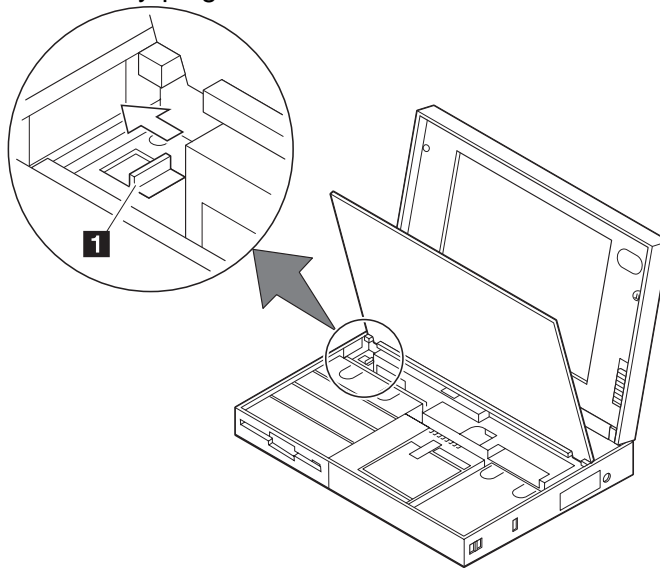

- 4** Remove the dummy plug **2** from the computer.

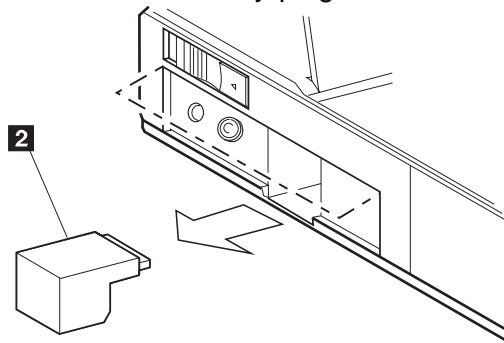

Installing the DAA/Telephony Kit

- 5** Make sure the latch is at the left-most position; then install the new plug with the round receptacle and firmly press it into the connector.

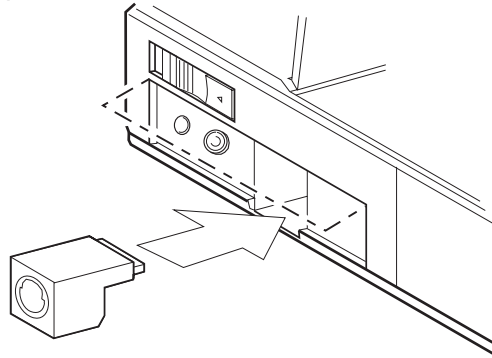

Warning:
Do not leave the lever in its middle position. Otherwise, you cannot close the keyboard.

- 6** Slide the lever to its right-most position until it clicks into place; then close the keyboard.

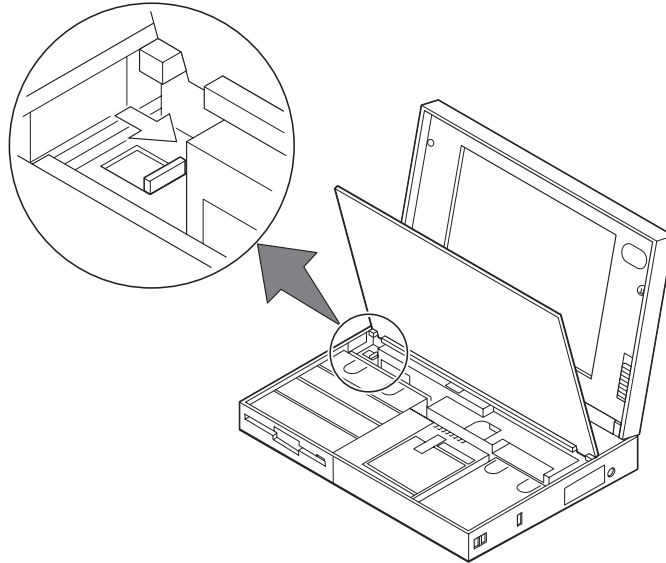

Installing the DAA/Telephony Kit

7 Connect the cables:



To avoid shock hazard, do not connect the telephone cable to or disconnect it from the computer during electrical storms.

Note:
Both ends of the DAA interface cable are identical.

- a) Connect one end of the DAA interface cable 1 to the connector plug with the round receptacle.
- b) Connect the other end of the DAA interface cable 2 to the round receptacle of the DAA.
- c) Connect the connector 3 of the ferrite-core end of the telephone cable to the square receptacle of the DAA.
- d) Connect the other end of the telephone cable to the telephone outlet 4 on the wall.

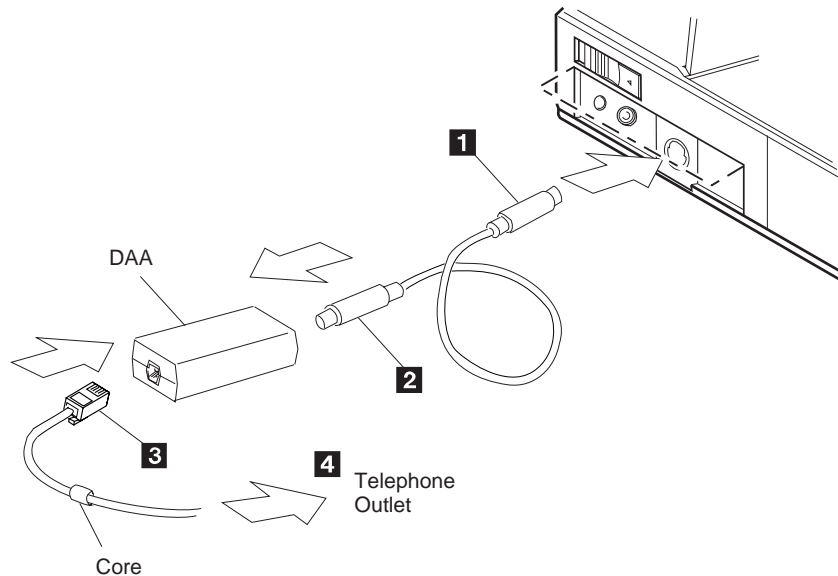

After you have completed attaching the modem/fax port, install the necessary software by referring to the manual that came with the option package.

Refer to "Using the Telephony Function" on page 84 for information about how to use the Mwave telephony features.

Attaching an External Numeric Keypad or a Mouse

Attaching an External Numeric Keypad or a Mouse

Warning:

When you connect a mouse other than IBM PS/2 Miniature Mouse, turn off the computer.

An external numeric keypad or a mouse can be attached directly to the connector on the right side of the computer. You can use both the IBM PS/2 Mouse and TrackPoint III as a pointing device. The PS/2 Mouse is plugged into the external input device connector of the computer and functions normally when the TrackPoint III is not actually moving the cursor.

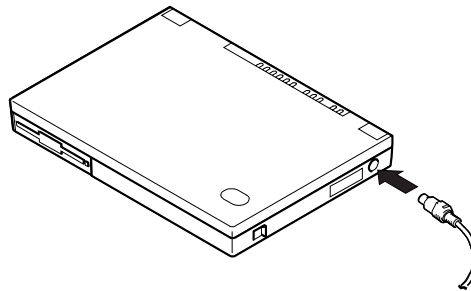

Note:

You can remove the keypad cover 1 and use it as a stand for the keypad.

If you want to use the external numeric keypad and mouse at the same time, first connect the keypad cable to the computer; then connect the mouse cable 2 to the connector at the rear of the keypad.

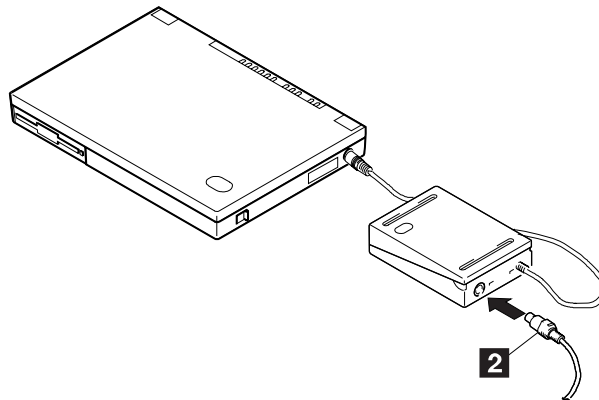
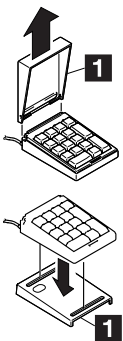

Attaching an External Numeric Keypad or a Mouse

Using the Mouse and Other Pointing Devices

Note:

The appropriate software must have been loaded already.

A serial mouse connected to the serial port, or a device, that is not compatible with the PS/2 Mouse, can be connected to the external input-device connector. Some mouse types require the TrackPoint III to be set to *Disable* to use them. Do the following to disable the TrackPoint III.



With OS/2 or Windows, do the following:

- 1** Start the ThinkPad Features program.
- 2** Select **Setup**.
- 3** Select **Keyboard/Pointing Device**.
- 4** Find the TrackPoint; then click on **Disable** to disable the TrackPoint III.

These changes will become effective when computer power is turned off and then on again.



With DOS, use the **PS2** command. Enter **PS2 ?** at the command prompt; then select appropriate **PS2** command.

 **PS2** command:
Page 41.

Note:

You also can use Easy-Setup to disable the TrackPoint III.

 To start Easy-Setup:
Page 42.

Attaching an External Numeric Keypad or a Mouse

Using a Mouse on the IBM ThinkPad Space Saver Keyboard

You can use the IBM ThinkPad Space Saver Keyboard instead of the keyboard of your computer. When you connect a mouse to the Space Saver Keyboard, you must disable the TrackPoint III of your computer. To disable the TrackPoint III, use either the ThinkPad Features program or the Utility Diskette to install the device driver.

Using the ThinkPad Features Program



With OS/2 or Windows, do the following:

- 1** Start the ThinkPad Features program.
- 2** Select **Setup**.
- 3** Select **Keyboard/Pointing Device**.
- 4** Find the TrackPoint; then click on **Disable** to disable the TrackPoint III.

These changes will become effective when computer power is turned off and then on again.



With DOS, use the **PS2** command.

 **PS2** command:
Page 41.

Note:
You also can use Easy-Setup to
disable the TrackPoint III.

 To start Easy-Setup:
Page 42.

Attaching an External Numeric Keypad or a Mouse

Using the Device Driver on the Utility Diskette



Note:
Do not install the device driver that is supplied with the Space Saver Keyboard.

When you use the Space Saver Keyboard, the device driver of the Utility Diskette automatically disables or enables the TrackPoint III of the computer when computer power is turned on. To install the device driver, do the following:

- 1** Turn on the computer and start the operating system; then insert the Utility Diskette into the diskette drive.
- 2** At the command prompt, type **A:UINSTALL** and press **Enter**.

The following screen appears:

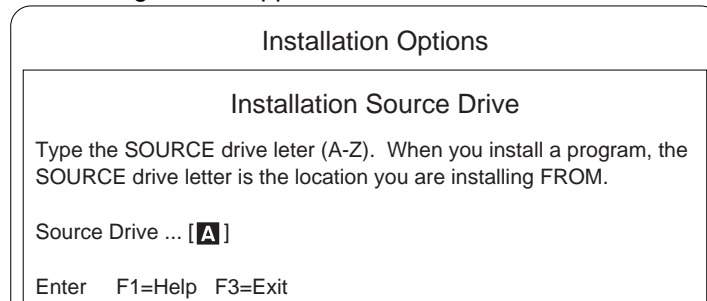

- 3** Press **Enter** and follow the instructions on the screen until the *Installation Options* menu appears.
- 4** Select the following according to your operating system:
 - If you are using OS/2, select **Install IBM ThinkPad Space Saver Keyboard Driver for OS/2**.
 - If you are using DOS or Microsoft Windows, select **Install IBM ThinkPad Space Saver Keyboard Driver for DOS**.
- 5** Follow the instructions on the screen.
- 6** After the installation has been successfully completed, close all applications, remove the Utility Diskette, and restart the system.

Attaching an External Keyboard

Attaching an External Keyboard

You can connect an external keyboard to your computer through the keyboard/mouse connector (separately available as an option).

Note:

The computer enters suspend mode when the LCD is closed. If you want to use the computer with the LCD closed, set the suspend option in the ThinkPad Features program so the computer does not enter suspend mode when the LCD is closed.

The external keyboard must be connected through the keyboard/mouse connector. It will not work if it is connected directly to the computer.

The external numeric keypad and the numeric keypad on the system keyboard cannot be used when the external keyboard is used.

 ThinkPad Features program:
Page 35.

Turn off the computer and attach the external keyboard.

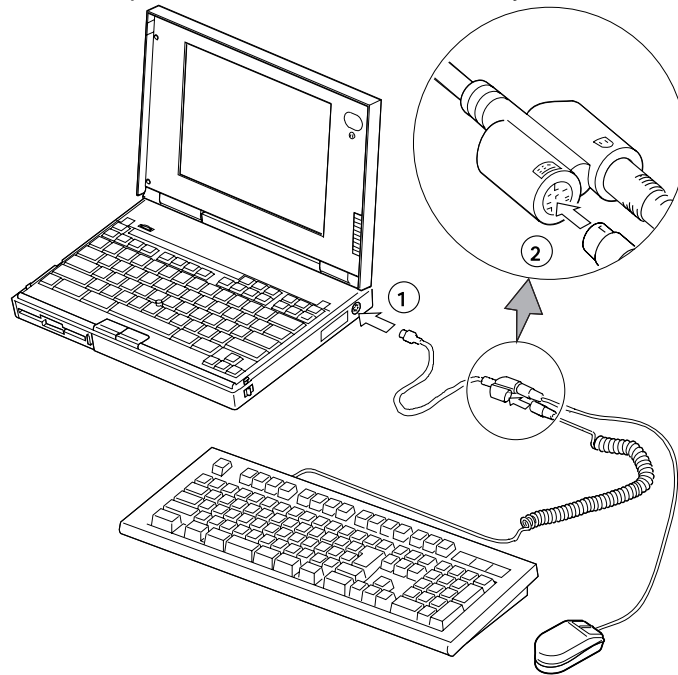

Attaching a Printer

Attaching a Printer

Most parallel printers with the standard Centronics** interface can be attached to the 25-pin parallel connector () at the rear of the computer.

1 Turn off the computer and attach the printer as shown.

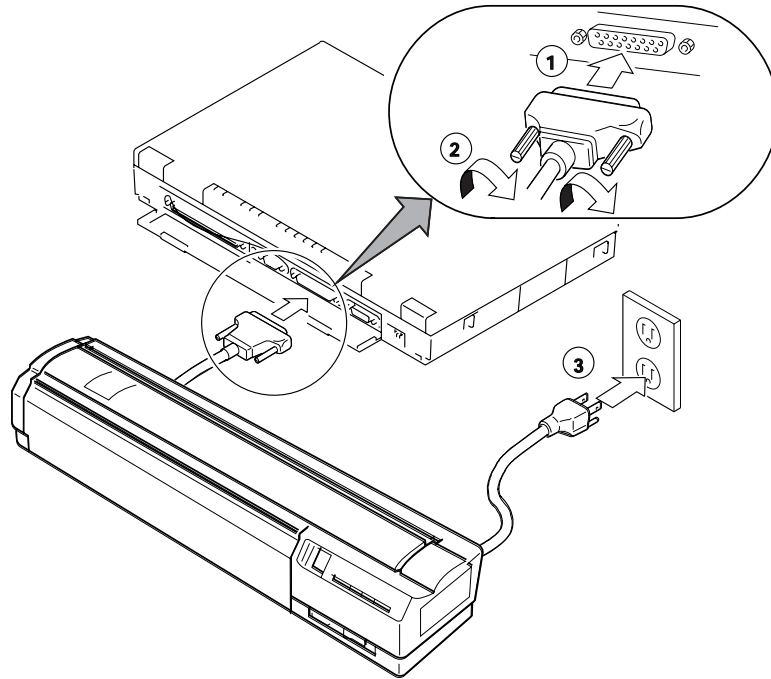

2 Turn on the computer and the printer.

Attaching an External Display

Note:

When installing an operating system, you must install the display driver before you can use the external display.



To install the display driver:
Page 188.

Note:

When you use the 755CX SVGA model and set the display mode to **Both**:

Do not attach the external display that supports only VGA mode (640-by-480 resolution) to the computer. Otherwise, the screen of the external display is disordered and the output is not displayed.

The screen image on the external display may appear smaller than the actual display size when you use the DOS application that supports only VGA mode.

The computer can display information on the LCD as follows:

755CX SVGA model supports SVGA (800-by-600 resolution) video mode and VGA (640-by-480) with 65 536 colors.

755CX VGA model supports only VGA mode with 65 536 colors.

A 1024-by-768 resolution video at maximum can be produced on any attached external display that supports the resolution mode.

When you attach an external display, do the following:

1. Change the display mode to **CRT** or **Both**. (See “Changing the Display Mode” on page 166.)
2. Set your monitor type and display device driver. (See “Setting the Monitor Type and the Display Driver” on page 167.)
3. Attach the external display to the computer. (See “Connecting the External Display to the Computer” on page 169.)

Attaching and Replacing an External Display

Changing the Display Mode

You can display information on the LCD, the external display, or both by using the following commands.



Using the **Fn** key function:

Press and hold the **Fn** key; then press the **F7** key. The output is displayed sequentially as follows:

```
External    Both
Display

LCD
```

Entering a **PS2** command from the command prompt:

- Type **PS2 SC BOTH** to display information on both the LCD and external display.
- Type **PS2 SC CRT** to display information on the external display.
- Type **PS2 SC LCD** to display information on the LCD.



Using the ThinkPad Features program:

1. Start the ThinkPad Features program and select the **Display** icon.
2. Select:
 - **Both** to display information on both the LCD and external display.
 - **CRT** to display information on the external display.
 - **LCD** to display information on the LCD.
3. Click on the **OK** button.

Setting the Monitor Type and the Display Driver

Before attaching the external display to your computer, set the appropriate monitor type and device driver type as follows:



1 Start the ThinkPad Features program.

2 Select the **Display** icon.

First, change **Monitor** settings by using the ThinkPad Features program:

3 Select **Monitor**.

4 Select your display type from the Monitor Selection list, or click on the new resolution and VSYNC (refresh rate) from the list.

5 Click on **OK**.

Next, change **Device Driver** settings as follows:

For OS/2 Warp:

1 Open the **OS/2 System** folder.

2 Double-click on the **System Setup** icon; then click on the **System** icon.

3 Select the new resolution and the number of colors.

4 Restart Warp to make the changes effective.

For OS/2 V.2.11 and Windows, use the ThinkPad Features program:

1 Select **Device Driver**.

2 Click on the new resolution and color depth; then click on **OK**.

3 Restart OS/2 or Windows to make the changes effective.

Note:

Refer to the specification of your external display about supported resolution and VSYNC.

Attaching and Replacing an External Display

Hints and Tips

When you are using Windows, the *virtual screen* function is available. It is used to display a part of the high-resolution screen image that is produced by the computer. Other parts can be seen by moving the screen with the TrackPoint III or other pointing device. To do this, see page 38.

Connecting the External Display to the Computer

Warning:

Do not disconnect the external display while the computer is in suspend mode or hibernation mode. If no external display is attached when the computer resumes, the LCD will remain blank and the output will not be displayed. It does not depend on the resolution value.

To attach an external display to the computer, do the following:

- 1** Turn off the computer.
- 2** Attach the external display to the external display connector () as shown.

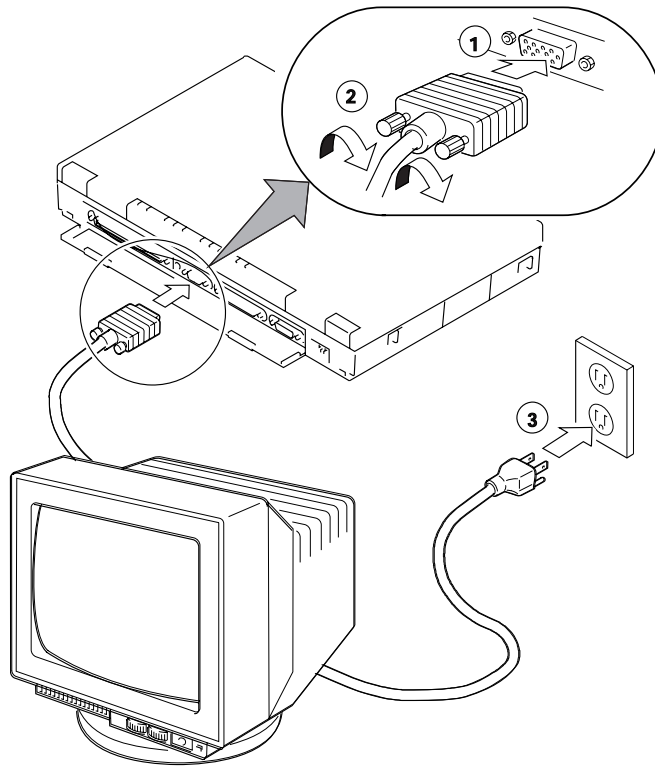

- 3** Turn on the external display and the computer.

Changing the Screen Resolution or Color Depth

To change the screen resolution or color depth of the external display, do the following:



For OS/2 Warp:

- 1** Open the **OS/2 System** folder.
- 2** Double-click on the **System Setup** icon; then click on the **System** icon..
- 3** Select the new resolution and the number of colors.
- 4** Restart Warp to make the changes effective.

For OS/2 V.2.11 or Windows:

- 1** Start the ThinkPad Features program.
- 2** Select the **Display** icon.
- 3** Select **Device Driver**.
- 4** Click on the new resolution and color depth; then click on **OK**.
- 5** Restart OS/2 or Windows to make the changes effective.

Attaching and Replacing an External Display

Using SVGA Display Drivers

The computer can display information on the attached SVGA display according to your operating system:

For OS/2 V.2.11:

Color	Resolution
256 colors	640 by 480
	800 by 600
	1024 by 768

For Windows:

Color	Resolution
256 colors or 64 gray scale	640 by 480
	800 by 600
	1024 by 768
32 768 colors or 65 536 colors	640 by 480
	800 by 600

Attaching the IBM Dock I or Dock II

Attaching the IBM Dock I or Dock II

Warning:
Do not use the Utility Diskette that came with the IBM Dock II.

Note:
When you dock the IBM Dock I or Dock II to the computer, see *Dock I User's Guide* or *Dock II User's Guide*.

Warning:
When setting up the Dock I or Dock II, avoid any hardware conflicts.

 To avoid hardware conflicts: Page 227.

To expand the ability of the computer, you can use an IBM ThinkPad Dock I or Dock II expansion unit. Either unit offers you a portable multimedia environment: CD-ROM compartment, stereo-speakers, and adapter slots for various adapter cards.

The following shows the computer attached to the Dock II.

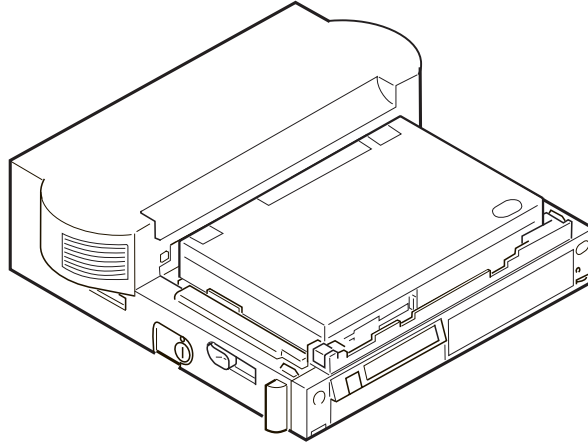

Hints and Tips

When the expansion unit is docked with the computer, you can adjust the sound volume of the IBM Dock I by using the following key combinations:

When you press and hold **Fn** and then press **PgUp** () , the sound volume increases.

When you press and hold **Fn** and then press **PgDn** () , the sound volume decreases.

Chapter 7. Installing Software

This chapter provides information about the software installed in the computer. It also describes how to install the necessary device drivers when you are reinstalling the operating system or if the operating system was not preinstalled at the time of purchase.

What You Need for Your Computer	174
Installing the Operating System	176
IBM OS/2 Warp or Version 2.11	176
IBM DOS Version 7.0 or Later	176
Microsoft Windows Version 3.11 or Later	177
Installing the ThinkPad Features Program	180
Installing for OS/2	180
Installing for DOS	181
Installing for Windows	182
Installing the PCMCIA Device Driver	183
Installing for OS/2	185
Installing for DOS	186
Installing for Windows	187
Installing the ThinkPad Display Driver	188
Installing for OS/2 Warp	189
Installing for OS/2 V.2.11	189
Installing for Windows	191
Installing the Mwave Support Software	192
Installing for OS/2	192
Installing for DOS	194
Installing for Windows	195
Installing the Infrared Device Driver	196
Installing for OS/2	196
Installing for Windows	197

Software Considerations

What You Need for Your Computer

The operating systems supported by the computer are:

- IBM DOS Version 7.0 or later
- IBM DOS Version J6.3/V or later
- IBM Operating System/2 (OS/2) Warp Version 3.0
- IBM Operating System/2 (OS/2) Version 2.11
- Microsoft Windows Version 3.11 or later
- Microsoft Windows for Workgroup Version 3.11 or later

When installing an operating system, you also must install the following software in addition to the operating system for your computer to operate correctly:

- ThinkPad Features program
- PCMCIA device driver
- ThinkPad display driver
- Mwave support software
- Infrared support software

Important

If you will be installing Windows Version 3.11 or later, you *must*:

Install the ThinkPad display driver instead of the default device drivers that came with Windows Version 3.11.

Type **C** to select Custom Setup when the Windows Setup program asks you to select **Express Setup** or **Custom Setup**.

Hints and Tips

If you are using DOS and do not use PC Cards, you can increase the memory area for application programs by releasing the area used for PC Cards. See "Releasing the PCMCIA Memory Area" on page 240 for details.

Software Considerations

The following figure shows what must be installed for each operating system before you begin computer operation:

Page Numbers:

For OS/2:

- 1 Page 176.
- 2 Page 180.
- 3 Page 185.
- 4 Page 192.
- 5 Page 196.
- 6 Page 189.
- 7 Page 189.

For DOS:

- 8 Page 176.
- 9 Page 181.
- 1 Page 186.
- 11 Page 194.

For Windows:

- 12 Page 176.
- 13 Page 181.
- 14 Page 194.
- 15 Page 177.
- 16 Page 182.
- 17 Page 187.
- 18 Page 195.
- 19 Page 197.

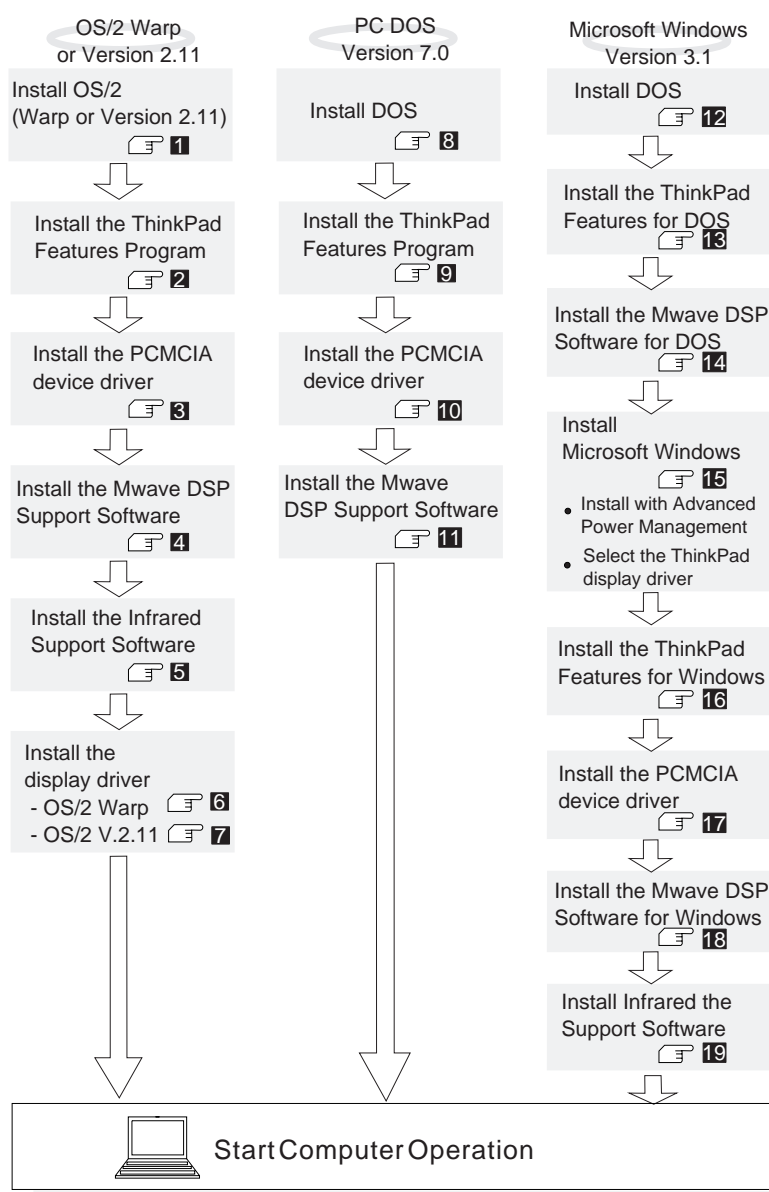

Installing the Operating System

Refer to the appropriate section in the following to install your operating system.



IBM OS/2 Warp or Version 2.11

Follow the instructions in the operating-system documentation.

After OS/2 Warp has been successfully installed, go to "Installing the ThinkPad Features Program" on page 180.

Important

When installing the operating system, select the choices so that PCMCIA is supported. PCMCIA will not be supported if you select *Install Preselected Features*.

A square icon with rounded corners containing the text "DOS" in a bold, sans-serif font.

IBM DOS Version 7.0 or Later

Follow the instructions in the operating-system documentation.

Go to "Installing the ThinkPad Features Program" on page 180. If you are installing Microsoft Windows Version 3.11 or later, install the ThinkPad Features program for DOS before you install Windows.



Microsoft Windows Version 3.11 or Later

Windows operates in a DOS environment. Install DOS Version 7.0 or later (see the DOS documentation); then install the ThinkPad Features program for DOS (see page 181) before you install Windows.

Do the following to install Windows Version 3.11 with Advanced Power Management (APM) and to select the ThinkPad display driver.

- 1 Install Windows Version 3.11 *with* the APM option as follows:

Important

When the Windows Setup program asks you to select *Express Setup* or *Custom Setup*, type **C** to select *Custom Setup*.

- a) Start the installation as specified in the Windows manual.
- b) When the Windows Setup program asks you to select *Express Setup* or *Custom Setup*, type **C** to select **Custom Setup**.

If you have installed OS/2, the path to install Windows might have been changed to: C:\OS2\MDOS\WINOS2 (C is the drive on which you installed OS/2). If so, change the path to: C:\WINDOWS.

- c) Continue installing Windows Version 3.11 until the following screen appears:

```
Windows Setup
=====

Setup has determined that your system includes the following hardware
and software components. If your computer or network appears on the
Hardware Compatibility List with an asterisk, press F1 for Help.

Computer:      MS-DOS System
Display:       VGA
Mouse:         Microsoft, or IBM PS/2
```

- d) Using **Up Arrow** (↑), select **MS-DOS System**; then press **Enter**.
- e) Using **Down Arrow** (↓), select **MS-DOS System with APM**; then press **Enter**.

Installing the Operating System

Note:

Verify that **Computer** has changed to **MS-DOS System with APM**. If the item has not changed, return to step 1d.

```
Windows Setup
=====

Setup has determined that your system includes the following hardware
and software components. If your computer or network appears on the
Hardware Compatibility List with an asterisk, press F1 for Help.

    Computer:      MS-DOS System with APM
    Display:       VGA
    Mouse:         Microsoft, or IBM PS/2
```

2 Select your display resolution type:

- a) Using **Up Arrow** (↑), select **Display**; then press **Enter**.
- b) Select **Other (Requires disk...)** from the menu; then press **Enter**.
- c) Insert the Video Features Diskette for Windows into the diskette drive; then type **A:** and press **Enter**.
- d) Select your desired resolution from the menu; then press **Enter**. (**nnn×nnn** is the resolution type of your display.)

Note:

Verify that **Display** has changed to your desired resolution type. If the item has not changed, return to step 2a.

If you are not sure which resolution to choose, choose **800x600 256 colors small fonts** for 755CX SVGA model, or **640x480 256 colors small fonts** for 755CX VGA model.

```
Windows Setup
=====

Setup has determined that your system includes the following hardware
and software components. If your computer or network appears on the
Hardware Compatibility List with an asterisk, press F1 for Help.

    Computer:      MS-DOS System with APM
    Display:       WD9 C24 nnn×nnn
    Mouse:         Microsoft, or IBM PS/2
```

- e) Press **Enter** to continue the installation.

Installing the Operating System

- 3** When you have completed the installation of Windows Version 3.11, edit the AUTOEXEC.BAT file so that the computer will use the correct mouse driver.

When Windows Version 3.11 is installed, the computer might be automatically configured to use the mouse driver (MOUSE.COM) provided by Windows Version 3.11. However, for correct operation, your computer must use the mouse driver that came with DOS.

- a)** At the DOS prompt (usually C:\>), type **E AUTOEXEC.BAT**; then press **Enter**.
- b)** Find the line with the `MOUSE` statement. If the line is as the following, change it to: `C:\WINDOWS\MOUSE.COM /Y`
- c)** Change it to: **C:\DOS\MOUSE.COM /Y**
- d)** Save the file and restart the system.

Note:

When you start Windows from the DOS prompt, do not close the LCD while the program is loading; if you do, the computer will stop running.

You have completed the installation of Windows.

Go to “Installing the ThinkPad Features Program” on page 180.

Installing the ThinkPad Features Program

Installing the ThinkPad Features Program

When installing an operating system, you must install the ThinkPad Features program that is on the Utility Diskette to set up the programs used with your computer. Follow the instructions for your operating system.

For OS/2, see "Installing for OS/2."

For DOS, see "Installing for DOS" on page 181.

For Windows, see "Installing for Windows" on page 182.



Installing for OS/2

To install the ThinkPad Features program for OS/2, do the following:

- 1** Turn on the computer and start the operating system.
- 2** Install the ThinkPad System Management device driver.
 - a)** Insert the Utility Diskette into the diskette drive.
 - b)** Open the OS/2 full screen command prompt.
 - c)** Type **DDINSTALL**; then press **Enter**.
 - d)** Click on the **Install...** button.
 - e)** Click on **ThinkPad System Management Device Driver**; then click on **OK**.
- 3** Open the OS/2 full-screen command prompt.
- 4** Go to the **A:** prompt and type **INSTALL2**; then press **Enter**.

You have completed the installation of the ThinkPad Features program.

Using PS2 command in OS/2 Environment

To use the **PS2** command in the DOS session of OS/2, install the program at the DOS full screen using the same procedure that you used to install for DOS. (See page 181.)

Note:

To open the OS/2 full screen:

- 1.** Double-click on **OS/2 System**.
- 2.** Double-click on **Command Prompts**.
- 3.** Double-click on **OS/2 Full Screen**.



PS2 command:
Page 41.

Go to "Installing the PCMCIA Device Driver" on page 183.

Installing the ThinkPad Features Program

DOS

Installing for DOS

To install the ThinkPad Features program for DOS, do the following:

- 1** Turn on the computer and start the operating system.
- 2** Insert the Utility Diskette into the diskette drive; then type **A:UINSTALL** at the DOS prompt and press **Enter**.

The following screen appears.

```
Installation Options

Installation Source Drive

Type the SOURCE drive letter (A-Z). When you install a program, the
SOURCE drive letter is the location you are installing FROM.

Source Drive ... [A]

Enter  F1=Help  F3=Exit
```

- 3** Press **Enter**.
- 4** Select **Install DOS ThinkPad Features and Fuel-Gauge Program** from the *Installation Options* menu; then follow the instructions on the screen.

You do not need to restart the computer when proceeding to the installation of the PCMCIA device driver.

You have completed the installation of the ThinkPad Features program.

Go to “Installing the PCMCIA Device Driver” on page 183 to install the necessary software for PC Cards. If you do not plan to use PC Cards, go to “Installing the ThinkPad Display Driver” on page 188.

Installing the ThinkPad Features Program



Installing for Windows

If you are going to use Windows, install the ThinkPad Features program for DOS first (see page 181); then do the following to install the ThinkPad Features program for Windows.

- 1 Turn on the computer and start Windows.
- 2 Select **File** from the Program Manager window; then select **Run...** from the pull-down menu.

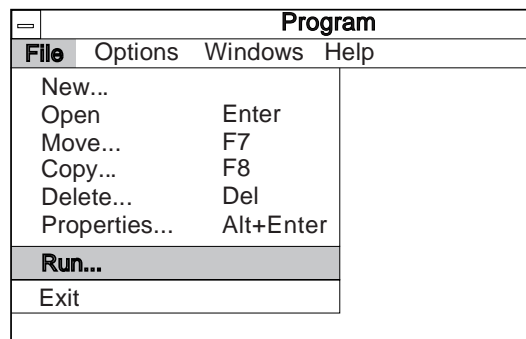

- 3 Insert the Utility Diskette into the diskette drive.
- 4 Type **A:\INSTALLW**; then press **Enter**.
Follow the instructions on the screen.

You have completed the installation of the ThinkPad Features program.

Using PS2 command in the Windows Environment

To use the **PS2** command in the DOS session of Windows, install the program at the DOS full screen. (See page 181.)

 **PS2** command:
Page 41.

Go to "Installing the PCMCIA Device Driver" on page 183.

Installing the PCMCIA Device Driver

Note:

Do not install the Phoenix** PCMCIA support for IBM DOS 7.0. PC Card Director for Windows runs only in Enhanced mode of Windows 3.11 or later.

When installing an operating system, you must install the following device drivers and software associated with PCMCIA before you can use the PC Cards:

- Card Services
- Socket Services
- Resource map utility
- Power management utility
- PC Card Director
- PC Card client device drivers (only when PC Card Director does not support the PC Card)

Use the following tables to determine the appropriate installation instructions for the different operating systems.

For IBM OS/2 V.2.11:

Software	File Name	How to Install
Card Services	PCMCIA.SYS	Go to "Installing the PCMCIA Device Driver" for installation.
Socket Services	IBM2SS01.SYS	
Resource Map Utility	ICRMU01.SYS	
Power Management Utility	\$ICPMOS2.SYS	
PC Card Director	EZPLAY2.DLL EZPLAY2.HLP AUTODRV2.SYS AUTODRV2.INI	
PC Card Client device drivers	Varies among PC Cards.	Refer to the manual that came with the PC Card.

Installing the PCMCIA Device Driver

For IBM DOS Version 7.0 or later:

Only for DOS.
Only for Windows.

Software	File Name	How to Install
Card Services	IBMDOSCS.SYS	Installed with the PCMCIA device driver. (See "Installing the PCMCIA Device Driver" on page 183 for installation.)
Socket Services	IBMDSS01.SYS	
Resource Map Utility	DICRMU01.SYS	
Power Management Utility	\$ICPMDOS.SYS	
PC Card Director	EZPLAY.EXE EZPLAYW.EXE EZPLAYW.HLP AUTODRV.SYS AUTODRV.INI DISKDRV.SYS IBMVCD.386	
PC Card Client device drivers	Varies among PC Cards.	Refer to the manual that came with the PC Card.



Auto Configurator for PC Card Director:
Page 231.

With the PCMCIA device driver, you can use PC Card Director and Auto Configurator to see the details about the PC Cards installed in the PCMCIA slot.



Installing for OS/2

To install the PCMCIA device driver for OS/2, do the following:

- 1** Turn on the computer and start the operating system.
- 2** Insert the PCMCIA Features Diskette into the diskette drive.
- 3** Open the OS/2 full screen command prompt; then type **A:PCMINST2** and press **Enter**.
- 4** Follow the instructions on the screen.
- 5** After the installation has been successfully completed, close all applications, remove the PCMCIA Features Diskette from the diskette drive, and restart the system.

Note:

To restart the system:

- 1.** Move the cursor to a blank part of your OS/2 Desktop.
- 2.** Press the right button of your TrackPoint III or mouse.
- 3.** Select **Shut down**.

Note:

Whenever you update the CONFIG.SYS file, refer to "Software Considerations for OS/2" on page 234.

You have completed the installation of the PCMCIA device driver for OS/2.

Go to "Installing the ThinkPad Display Driver" on page 188.

Installing the PCMCIA Device Driver

DOS

Installing for DOS

To install the PCMCIA device driver for DOS, do the following:

- 1 Turn on the computer and start the operating system; then insert the PCMCIA Features Diskette into the diskette drive.
- 2 At the command prompt, type **A:UINSTALL** and press **Enter**.

The following screen appears:

The screenshot shows a text-based menu titled "Installation Options". Inside this menu is a sub-section titled "Installation Source Drive". Below this title, there is a line of text: "Type the SOURCE drive letter (A-Z). When you install a program, the SOURCE drive letter is the location you are installing FROM." Below this text is a prompt: "Source Drive ... [A]". At the bottom of the sub-section, there are three options: "Enter", "F1=Help", and "F3=Exit".

- 3 Press **Enter**.
- 4 Select **Install DOS PCMCIA Device Drivers** from the *Installation Options* menu; then follow the instructions on the screen.
- 5 After the installation has been successfully completed, close all applications, remove the PCMCIA Features Diskette from the diskette drive.
You do not need to restart the computer when proceeding to the installation of the ThinkPad display driver.

You have completed the installation of the PCMCIA device driver for DOS.

Go to "Installing the ThinkPad Display Driver" on page 188.

Note:
If you are using a software EMS driver, such as EMM386.EXE, see page 235. Whenever you update the CONFIG.SYS file, see page 238.



Installing for Windows

To install the PCMCIA device driver for Windows, do the following:

- 1 Turn on the computer and start the operating system.
- 2 Select **File** from the Program Manager window; then select **Run...** from the pull-down menu.

Program	
File	Options Windows Help
New...	
Open	Enter
Move...	F7
Copy...	F8
Delete...	Del
Properties...	Alt+Enter
Run...	
Exit	

- 3 Insert the PCMCIA Features Diskette into the diskette drive.
- 4 Type **A:PCMINSTW**; then press **Enter**.
- 5 Follow the instructions on the screen to complete the installation.

You have completed the installation of the PCMCIA device driver for Windows.

If you did not install the display driver when installing Windows, go to "Installing the ThinkPad Display Driver" on page 188.

Installing the ThinkPad Display Driver

Installing the ThinkPad Display Driver

The display driver provides a high-resolution mode for an attached SVGA display.

Note:

For more information of the display driver, see "Attaching an External Display" on page 165.

The display driver also increases the performance for OS/2 or Windows users. Follow the instructions for your operating system:

For OS/2, see "Installing for OS/2 V.2.11" on page 189 to install OS/2 device drivers, including the WIN-OS/2 device drivers.

For Windows, if you did not install the display driver when installing Windows, see "Installing for Windows" on page 191 to install Windows device drivers.

For DOS, display drivers have already been prepared in the computer as a basic function. You do not need to install them.

Note:

You can change the refresh rate of the external display with the **PS2** command.



PS2 command:
Page 41.

Installing the ThinkPad Display Driver



Installing for OS/2 Warp

Refer to the documentation that came with the display driver diskette for OS/2 Warp. Select the **WD90C24** display driver when installing the display driver.



Installing for OS/2 V.2.11

You must do the following before you install the Display Driver:

Before You Begin

Using the ThinkPad Features program, set the display device mode to *LCD*; select the **Display** icon; then **LCD**. Or, at the command prompt, type **PS2 SC LCD**; then press **Enter**.

Make sure you have the installation package for OS/2 2.11.

If you have installed OS/2 from CD-ROM, create display driver diskette 1 and 2 by LOADDSKF.EXE before installing the ThinkPad Display Driver.

1. Insert a blank diskette into the diskette drive; then type:

```
X:\DISKIMGS\LOADDSKF X:\DISKIMGS\OS2\35\DISP1.DSK A:
```

X is the drive for the CD-ROM drive.

2. Insert another blank diskette into the diskette drive; then type:

```
X:\DISKIMGS\LOADDSKF X:\DISKIMGS\OS2\35\DISP2.DSK A:
```

X is the drive for the CD-ROM drive.

3. Refer to the README.TXT file on the Video Features Diskette for information about the device driver.

 To install the ThinkPad Features program:
Page 180.

 ThinkPad Features program:
Page 35.

Note:

To open the OS/2 full screen:

1. Select **OS/2 System**.
2. Select **Command Prompts**;
then select **OS/2 Full Screen**.

Note:

All necessary files are copied to your hard disk drive in the following subdirectory names: \OS2, \OS2\DLL, \OS2\MDOS, \OS2\INSTALL, and \OS2\MDOS\WINOS2\SYSTEM.

- 1 Start OS/2 and open the OS/2 full screen.

- 2 Insert the Video Features Diskette for OS/2 into the diskette drive.

- 3 At the command prompt, type **A:**; then press **Enter**.

- 4 Type **INSTALL C** and press **Enter**; then follow the instructions on the screen.

C is the drive on which the device driver is to be installed; it can be something different.

Installing the ThinkPad Display Driver

Note:

To shut down OS/2:

1. Move the mouse pointer to a blank part of your OS/2 Desktop.
2. Press the right button of your TrackPoint III or mouse.
3. Select **Shut down**.

5 Remove the diskette from the diskette drive and shut down OS/2; then restart the system.

6 Open the OS/2 full screen, type **DSPINSTL**; then press **Enter**.

7 Follow the instructions on the screen.

When you are asked to enter the source directory, do the following:

- If OS/2 has been preinstalled on your computer, use the default directory on the screen. Do not change it.
- If OS/2 has *not* been preinstalled, enter **A:**.

When you are asked to select the display type, select **Primary Display**; then select **Western Digital** WD90C24, C24A on ThinkPad** for the LCD of the computer.

When you are asked to select the monitor configuration, select **Install Using Defaults for Monitor Type** and follow the instruction.

When you are asked to overwrite the target file, select **Yes**.

8 After the installation has been successfully completed, remove the diskette; then shut down OS/2 and restart the computer.

You have completed the installation of the display driver for OS/2.



Installing for Windows

If you did not install the display driver when Windows was installed (by following the procedures on page 177), install the display driver for Windows:

- 1** Exit Windows and go to the DOS prompt if Windows is running.
- 2** Go to the Windows subdirectory (C:\Windows>) and type **SETUP**; then press **Enter**.
- 3** Select **Display** from the *Windows Setup* menu; then select **Other (Requires disk...)** from the next menu.
- 4** Insert the Video Features Diskette for Windows into the diskette drive; then type **A:** and press **Enter**.
- 5** Select your favorite resolution and colors from the menu and follow the instructions on the screen.

Note:

If you are not sure which resolution to choose, choose **800x600 256 colors small fonts** for 755CX SVGA model, or **640x480 256 colors small fonts** for 755CX VGA model.

You have completed the installation of the display driver for Windows.

Installing the Mwave Support Software

Installing the Mwave Support Software

Note:

If you have multiple operating systems, you might need to install multiple versions of the Mwave support software. For example, to enable DOS and Windows applications for Mwave functions, two separate Mwave support software installations are required: one for DOS and one for Windows.

When installing an operating system, you must install the Mwave support software.

The Mwave support software is supplied in the Mwave DSP Features Diskettes or in the hard disk drive of your computer.

If the Mwave DSP Features Diskettes were not supplied with your computer, the support software is contained on the hard disk drive. See the READ.ME file in the root directory of the hard disk to install the Mwave DSP support software.

If the Mwave DSP Features Diskettes were supplied with your computer, install the Mwave support software as follows:

- For OS/2, see “Installing for OS/2.”
- For DOS, see “Installing for DOS” on page 194.
- For Windows, see “Installing for Windows” on page 195.



Installing for OS/2

Before installing the Mwave support software for OS/2, install Multimedia Presentation Manager/2 (MMPM/2), which comes with OS/2 V.2.11. Refer to the *OS/2 Version 2.11 Installation Guide* for instructions.

To install the Mwave support software for OS/2, do the following:

- 1** Turn on the computer; then start OS/2.
- 2** Open the OS/2 full screen.
- 3** Insert the Mwave DSP Features Diskette 1 for OS/2 into the diskette drive.
- 4** Type **A:SETUP**; then press **Enter**.
The installation window appears on the screen.
- 5** Follow the instructions on the screen.

Note:

To open the OS/2 full screen:

- 1.** Select **OS/2 System**.
- 2.** Select **Command Prompts**; then select **OS/2 Full Screen**.

Installing the Mwave Support Software

Note:

To shut down OS/2:

1. Move the mouse pointer to a blank part of your OS/2 Desktop.
2. Press the right button of your TrackPoint III or mouse.
3. Select **Shut down**.

- 6 Restart OS/2 to make the Mwave features effective.
- 7 Install Mwave MMPM audio support software as follows:
 - a) Insert the Mwave DSP Features Diskette for OS/2 Audio into the diskette drive.
 - b) Type **A:SETUP** at the command prompt; then press **Enter**.
 - c) Follow the instructions on the screen.
- 8 After the installation is complete, remove any diskette from the diskette drive; then restart OS/2 to activate the Mwave support software.

You have completed the installation of the Mwave support software for OS/2.

When You Use the WIN-OS/2 Environment

If you use the Mwave functions in the WIN-OS/2 environment, do the following:

- 1 Install the Mwave support software for Windows in a full-screen WIN-OS/2 environment with the procedure on page 195.
- 2 Check your **WIN-OS/2 Settings** and modify them as follows, referring to your OS/2 manuals:
WIN_RUN_MODE: 3.1 Enhanced Compatibility
HW_TIMER: ON
INT_DURING_IO: ON
DOS_BACKGROUND_EXECUTION: ON

Installing the Mwave Support Software

DOS

Installing for DOS

To install the Mwave support software for DOS, do the following:

- 1** Turn on the computer.
- 2** Insert the Mwave DSP Features Diskette 1 for DOS into the diskette drive.
- 3** At the command prompt, type **A:INSTALL**; then press **Enter**.

The following screen, which enables you to specify the directory location of Mwave support software, appears:

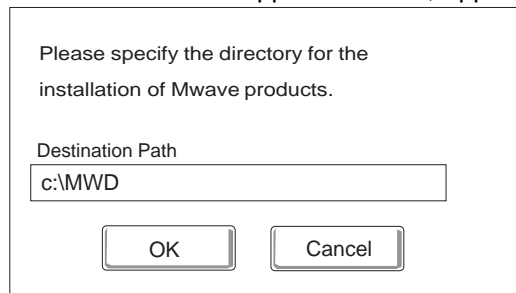

Please specify the directory for the installation of Mwave products.

Destination Path

c:\MWD

OK Cancel

- 4** If this directory is acceptable, press **Enter**. Otherwise, type the directory name; then press **Enter**.
- 5** Follow the instructions on the screen.
- 6** After the installation is complete, remove any diskette from the diskette drive; then restart DOS to activate the Mwave support software.

You have completed the installation of the Mwave support software for DOS.



Installing for Windows

Warning:
Before you install the Mwave support software, close all open applications.

To install the Mwave support software for Windows, do the following:

- 1** Turn on the computer; then start Windows.
- 2** Select **File** from the Program Manager window; then select **Run...** from the pull-down menu.
- 3** Insert the Mwave DSP Features Diskette 1 for Windows into the diskette drive.
- 4** Type **A:SETUP**; then press **Enter**.

The following screen, which enables you to specify the directory location of Mwave support software, appears:

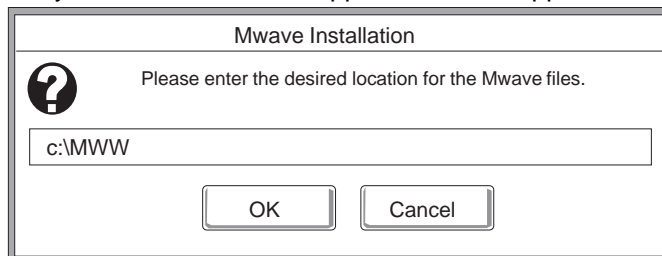

- 5** If this directory is acceptable, press **Enter**. Otherwise, type the directory name; then press **Enter**.
- 6** Follow the instructions on the screen.
- 7** After the installation is complete, remove any diskette from the diskette drive; then restart Windows to activate the Mwave support software.

You have completed the installation of the Mwave Windows support software.

Installing the Infrared Device Driver

When installing an operating system, you must install the IR (infrared) device drivers.

Follow the instructions for your operating system.

For OS/2, see "Installing for OS/2."

For Windows, see "Installing for Windows" on page 197.



Installing for OS/2

- 1** Turn on the computer and start OS/2.
- 2** If you have not installed DOS and WIN-OS/2 support for OS/2, install it by referring to your operating systems documents.
- 3** Go to the DOS command prompt.
- 4** Insert the Infrared Features Diskette into the diskette drive.
- 5** Type **A:UINSTALL**; then press **Enter**.

The following screen appears:

Installation Options

Installation Source Drive

Type the SOURCE drive letter (A-Z). When you install a program, the SOURCE drive letter is the location you are installing FROM.

Source Drive ... [**A**]

Enter F1=Help F3=Exit

- 6** Press **Enter**; then follow the instructions on the screen.

You have completed the installation of the infrared device drivers.

Go to "Installing the ThinkPad Display Driver" on page 188.

Note:
To go to the DOS command prompt:

1. Select **OS/2 System**.
2. Select **Command Prompts**; then select **DOS Full Screen**.



Installing for Windows

- 1** Turn on the computer; then go to the DOS command prompt.
- 2** Insert the Infrared Features Diskette into the diskette drive.
- 3** Type **A:UINSTALL**; then press **Enter**.

The following screen appears:

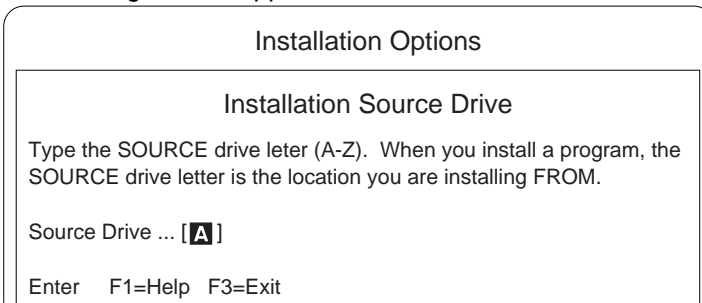

- 4** Press **Enter**; then follow the instructions on the screen.

You have completed the installation of the infrared device drivers.

Go to “Installing the ThinkPad Display Driver” on page 188.

Installing the Infrared Device Driver

Chapter 8. Solving Computer Problems

Computer problems can be caused by software, hardware, or both. Many problems can be diagnosed and solved with the assistance of self-tests and system programs. If a hardware problem is detected by the self-tests, an error message is displayed.

The system programs can identify a problem or provide information for the service representative. Make a note of all error codes and give them to the service representative when you call for service. If the system programs cannot be loaded, the troubleshooting charts and other information will help you determine what corrective action to take.

Important

Use this chapter to test only *IBM* products. Non *IBM* products can cause misleading error information or incorrect computer responses. When testing non *IBM* products, refer to the instructions supplied with those products.

Commonly Asked Problems and Actions	200
Testing the Computer	202
Troubleshooting Charts	204
LCD Problems	204
Screen Messages	206
Error Codes	208
General Problems	210
What If Testing Cannot Find the Problem?	211
Battery Power Problems	211
Diskette Drive Problems	213
Mwave DSP Feature Problems	213
Infrared Communication Problems	214
Software Problems	215
Option Problems	215
Keyboard, External Numeric Keypad, and Pointing Device Problems	216
External Display Problems	218
Printer Problems	220
Intermittent Problems	220
Listing Installed Options	221
Recording Identification Numbers	222
Getting Service	223
The IBM HelpClub: Another Great Choice (for European Countries)	224
Yours for a free trial period.	224
Join the HelpClub!	225

Commonly Asked Problems and Actions

This section provides a list of possible common problems that you might have with their corresponding actions.

P: A **memory shortage or memory error** occurs.

A: Do one of the following:

Unload any unnecessary drivers from the CONFIG.SYS file.

If you are using DOS, use the multiple configuration setup of DOS (refer to the documents supplied with the DOS operating system).

P: The **external display** screen is blank.

A: Do the following:

1. Make sure the display device parameter of the ThinkPad Features program is correctly specified to use the external display.

2. Set the computer not to enter suspend mode when the LCD is closed by using the ThinkPad Features program.

P: The computer does **not resume from suspend mode**, or the suspend indicator stays on and the computer does not work.

A: The computer automatically enters suspend or hibernation mode when the battery pack is empty. Do one of the following:

Replace the battery pack with a fully charged one.

Connect the AC Adapter to the computer and charge the battery pack.

P: When using Windows, the **cursor does not move** after normal operation is resumed from one of the power-saving modes.

A: Make sure you have installed Windows with the APM option by following the procedures on page 177.

P: The computer does **not enter suspend or hibernation mode**.

A: Do one of the following:

If the computer is attached to the Dock I, suspend mode is disabled.

If the AC Adapter is used and the computer is communicating, suspend and hibernation modes are disabled.

What If Your Computer Does Not Work?

P: The **PC Card modem** does not work.

A: Do the following:

1. Start the PC Card Director and check the serial port name (COM1–COM4) assigned to the modem card.
2. Open your PC Card application; then assign the serial port name for the modem.

P: The **battery pack** loses power too soon.

A: Repeat the complete discharging and charging procedure two to three times. See “Preserving Battery-Pack Life” on page 103 for more information.

P: The **battery status indicator** blinks.

A: If you use the NiMH battery pack, slide the switch on the battery pack to the on position (|) with a ballpoint pen.

P: **Error 2XX** appears (memory error).

A: Make sure your memory card is correctly installed.

Testing the Computer

1 Turn on the computer.

The power-on self-test (POST) runs automatically. If the test ends without detecting an error, one of the following occurs:

The operating system or application screen appears.

A password prompt appears on the screen, if a password has been set. Type the correct password and press **Enter**.

The **Diskette** and **F1** prompts (shown below) appear.

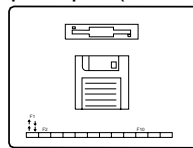

This means no operating system is installed in your computer. Install it now.

Did one of these screens appear?

Yes Turn off the computer and continue with step 2.

No Go to page 204.

2 Press and hold **F1**; then turn on the computer to start Easy-Setup. Hold **F1** until the following *Easy-Setup* menu appears.

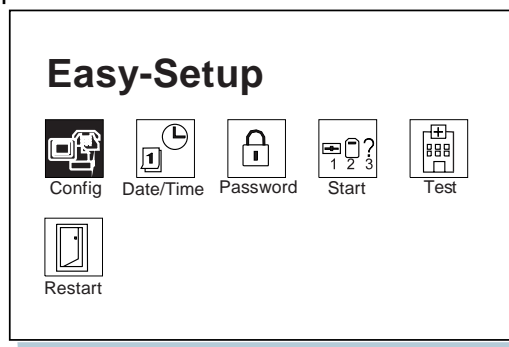

3 Did the *Easy-Setup* menu appear on the screen?

Yes The computer has successfully completed the POST (internal tests), and the system programs have been loaded. To start the test programs, select the **Test** icon; then select the **Start** icon or press **Enter**.

What If Your Computer Does Not Work?

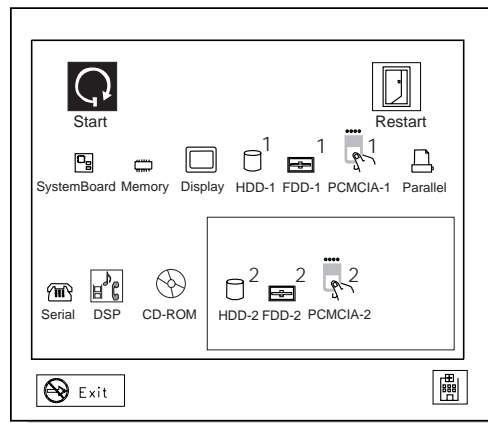

If the computer did not beep, the speaker is not working correctly. Have the computer serviced. If you are not sure about the beep, turn off the computer; then turn it on again and repeat step 2 on page 202.

If you cannot go beyond the first screen, have the computer serviced.

If an error is detected, the character X appears at the left of the affected device, and an error code appears below it. Record the error code and have the computer serviced.

If the test does not find a problem but one still exists, find the problem in the troubleshooting charts on page 204.

- No** Return to step 2 on page 202 and start Easy-Setup again. If you still cannot start Easy-Setup, find the problem in the troubleshooting charts from page 204.

What If Your Computer Does Not Work?

Troubleshooting Charts

In the charts, x can be any character.

LCD Problems

Problem	Action
The screen is blank and there are no beeps. Note: If you are not sure about the beeps, turn the computer off; then turn it on again, and listen for the beep.	Verify that: The battery pack is correctly installed. The AC Adapter is connected to the computer and the power cord is plugged into a working electrical outlet. The computer power switch is turned on. If preceding items are correct and the screen remains blank, have the computer serviced.
The screen is blank and there is one beep. Note: If you are using an external display, go to "External Display Problems" on page 218.	If a power-on password is set, type the correct password and press Enter (see page 110). If a power-on password is not set, verify that: The brightness control on the computer is correctly adjusted. The <i>Display device</i> parameter of the ThinkPad Features program is correctly specified. If the preceding items are correct and the screen remains blank, have the computer serviced.
The screen is blank and there is a continuous beep, or two or more beeps.	Have the computer serviced.
Only the cursor appears.	Have the computer serviced.
xxxxx KB OK appears and the computer halts.	Have the computer serviced.
The screen is unreadable or distorted.	Verify that the ThinkPad display driver was installed correctly (see page 188). Verify that Display in the Windows Setup screen is set to your display resolution type (see page 177). If these are correct, test the computer. If the test ends without an error, have the computer serviced.
Incorrect characters appear on the screen.	Verify that operating systems and application programs have been installed and configured correctly. If so, have the computer serviced.

What If Your Computer Does Not Work?

Problem	Action
The screen image appears smaller than the LCD size (using a DOS application on a 755CX SVGA model only).	This is to maintain compatibility with the DOS application; it is not a problem.
When you use DOS Shell or some kind of application in the DOS environment, the lines on the screen are disordered. (755CX SVGA model only)	<p>Verify that:</p> <p>If you are using DOS Shell and have set the screen mode 800-by-600 resolution with the PS2 MODE3X command, do the following:</p> <ol style="list-style-type: none"> 1. At the DOS Shell screen, select Options from the menu bar; then select Display.... 2. Select Graphics 30 lines Medium Resolution 1; then select OK. The screen will recover. <p>If you are using an application other than DOS Shell, do the following:</p> <ul style="list-style-type: none"> – At the DOS command prompt, type PS2 MODE3X OFF; then press Enter.
The screen stays on although the power switch is turned off.	Press the Power Shutdown switch on the rear of the computer with the tip of a pen to turn off the computer; then turn the computer on again.
The computer goes into suspend mode immediately after the POST. (The suspend mode indicator turns on.)	<p>Verify that:</p> <p>The battery pack is charged. (The battery power status indicator is green or yellow.)</p> <p>Keyboard is firmly closed.</p> <p>When the external display is attached to the computer, the Will not suspend even if LCD is closed option (in the Suspend/Resume options of the ThinkPad Features program) is not enabled. (See page 35.)</p> <p>The environmental temperature is in an acceptable range. Refer to "Specifications" on page 251.</p> <p>If the preceding items are correct, have the computer serviced.</p>
Error 190 appears and the computer immediately turns off.	The battery pack is low in power. Connect the AC Adapter to the computer, or replace the battery pack with a fully charged one.
Missing, discolored, or bright dots appear on the screen at all times.	The computer LCD contains more than 1 440 000 (for the 755CX SVGA model) or 921 000 (for the 755CX VGA model) thin-film transistors (TFTs). A small number of missing, discolored, or bright dots on the screen is an intrinsic characteristic of TFT LCD technology and is not an LCD defect.

What If Your Computer Does Not Work?

Screen Messages

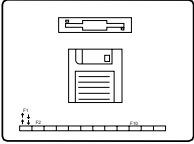
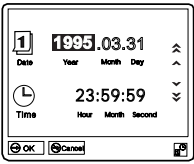
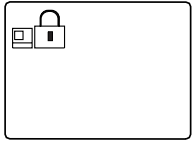
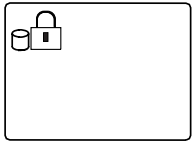
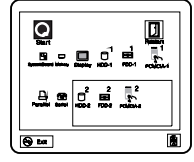
Message	Action
<p>Diskette and F1 prompts.</p> 	<p>Verify that hard disk drive is correctly installed. Or, verify that the self-starting diskette is inserted correctly (with the label up and metal-shutter end first) in the diskette drive.</p> <p>If so, press F1. If both prompts remain, have the computer serviced.</p>
<p>Error 163 appearing with the date and time screen.</p>  <p>The date and time screen appears when neither the date nor the time is set in the computer.</p>	<p>Set the date and time by typing or clicking on the ▲ or ▼ to set the numbers; then click on the OK button.</p>
<p>Power-on password prompt.</p> 	<p>A power-on or supervisor password was set. To use the computer, type the correct password and press Enter (see page 110).</p> <p>If the power-on-password is not accepted, a supervisor password might have been set. Type the supervisor password and press Enter.</p> <p>If there is still a problem, have the computer serviced.</p>
<p>Hard-disk password prompt.</p> 	<p>A hard-disk password was set. To use the computer, type the correct password and press Enter (see page 110).</p> <p>If there is still a problem, have the computer serviced.</p>
<p>Test menu.</p> 	<p>Select the Start icon and follow the instructions to test your system.</p> <p>If you cannot go beyond the first screen, have the computer serviced.</p> <p>If the computer stops during testing and does not continue, have the computer serviced.</p> <p>If testing does not find a problem but one still exists, find the problem in "What If Testing Cannot Find the Problem?" on page 211.</p>

What If Your Computer Does Not Work?

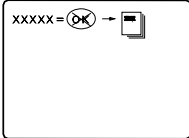
Message	Action
<p>POST error prompt.</p> 	<p>An error was found during the POST. Press Enter; then select Start from the test menu to run the test.</p> <p>If the test ends with an error, make a note of the error code and have the computer serviced.</p>
<p>Error prompt.</p> 	<p>Turn off the computer and start Easy-Setup; then select Test to test the computer.</p> <p>You can start the operating system by pressing F1 instead and ignore the error.</p>
<p>A screen or message that is not listed.</p>	<p>Turn off the computer and start Easy-Setup; then select Test to test the computer.</p> <p>If you cannot start Easy-Setup, have the computer serviced.</p>

What If Your Computer Does Not Work?

Error Codes

Screen Message	Action
I9990301 I9990302 I9990305 Note: Incorrect connection of the hard disk drive can cause these error codes to appear.	The computer cannot find the startup drive. Action: <ol style="list-style-type: none"> 1. Turn off the computer. 2. Press and hold F1; then turn on the computer to start Easy-Setup. Hold F1 until the Main Menu appears. 3. Select the Start up icon. If you are unable to set the startup sequence, have the computer serviced. 4. Check the list of devices on the Set Startup Sequence screen. Is the default drive in the startup sequence? Yes Exit this screen, and turn off the computer. No Select the Reset icon. 5. Is an operating system installed? Yes Go to step 7. No Install the operating system in your computer. 6. After the operating system is installed, turn off the computer. 7. Turn on the computer. If the same screen message appears, have the computer serviced.
I99xxxxx	Have the computer serviced.
111	If you are using a Port Replicator or an expansion unit, disconnect it; then reconnect it. If there is still a problem, have the computer serviced.
158	A hard disk drive without a hard-disk password is installed when a supervisor password is set. Action: <ol style="list-style-type: none"> 1. Press Enter. The password menu in Easy-Setup appears. 2. Select the Hard-Disk icon. 3. Press Enter. The same password as the supervisor password is set for the hard-disk password on the hard disk drive.
159	The hard-disk password differs from the supervisor password. Action: <ol style="list-style-type: none"> 1. Turn off the computer; then turn it on again. 2. Change the hard-disk password to the supervisor password at the hard-disk password prompt.
16x or 17x	Follow the instructions on the screen.
174	There is a device configuration error. Check that the hard disk drive and the diskette drive are installed firmly in the connectors.

What If Your Computer Does Not Work?

Screen Message	Action
184	The entered password is invalid. Turn off the computer and wait at least 5 seconds; then turn it on again and type the correct password.
190	The computer has turned off because of a critically low-battery condition. Action: Connect the AC Adapter to the computer and charge the battery pack.
195	The system configuration before and after hibernation mode differs, and the computer cannot resume normal operation. Action: Change the system configuration to what it was before the computer entered hibernation mode. If the memory size is changed, re-create the hibernation file (see page 59).
196	The computer cannot read the hibernation file. Have the computer serviced.
2xx	Verify that the IC DRAM card or DIMM option is correctly installed.
30x	Turn off the computer and all attached devices. Turn on the computer first; then turn on the attached devices. If the computer has an external keyboard connected, verify that: <ol style="list-style-type: none"> 1. The external keyboard is connected to the correct side of the keyboard/mouse connector (see page 163). 2. The keyboard/mouse connector is correctly connected to the computer. If the preceding items are correct, disconnect the keyboard/mouse connector from the computer and verify that the operation of the system keyboard is correct. If the system keyboard works correctly, have the keyboard/mouse connector or the external keyboard serviced. Test the computer by selecting the Start icon. <ul style="list-style-type: none"> – If the computer stops during testing and does not continue, have the computer serviced. – If the tests do not find a problem but one still exists, find the problem in “What If Testing Cannot Find the Problem?” on page 211.

What If Your Computer Does Not Work?

General Problems

Problem	Cause or Action
The computer performance is getting worse in an environment where the temperature is higher than the product specifications. (See "Specifications" on page 251.)	Processor speed may decrease if the computer is used in a high-temperature environment.
Problems such as a broken keylock or an indicator not working.	Have the computer serviced.
The computer does not turn off with the power switch.	If the suspend indicator is turned on, connect the AC Adapter or install a fully charged battery pack to the computer; then resume it. If there is still a problem, press the Power Shutdown switch on the rear of the computer with the tip of a pen to turn off the computer.
The application locks up or the computer does not accept any input.	Press the Power Shutdown switch on the rear of the computer with the tip of a pen to turn off the computer; then turn the computer on again.
The computer does not start from a diskette.	Check that the startup sequence is set to start the computer from the diskette drive (see page 47).
Keyboard cannot be opened.	Check that the locking lever for the hard disk drive is unlocked or that the Kensington lock is not used.

What If Testing Cannot Find the Problem?

If the test programs do not find the problem, use the following troubleshooting charts:

Battery Power Problems

Problem	Action
The battery pack starts discharging automatically, even if the AC Adapter is connected.	When the AC Adapter is connected, and the remaining power of the installed battery pack is less than a certain amount, discharging and then charging of the battery pack starts automatically.
When you are using OS/2 or Windows, the message, "Please discharge battery" appears on the screen.	Discharge the battery pack; then recharge it (see page 100).
The computer does not operate with a fully charged battery pack.	Discharge the battery pack; then recharge it (see page 98). If there is still a problem, have the computer serviced.
A fully charged NiMH battery pack discharges too soon.	The battery pack is either old or its operation time has been shortened by repeatedly charging it when it was not completely discharged. Action: <ol style="list-style-type: none">1. Check if the battery pack you are using has been charged for more than 2 hours by the power-off charging method.2. If so, repeat the complete discharging and charging procedure three to six times (see page 98). Note: A fully charged battery gradually loses its power when not used for a long period of time. If the battery pack is not used for a long period of time, or if it is new, the battery does not reach full charge with only one charging.3. If the battery pack still discharges too soon, replace the battery pack with a new one. If there is still a problem, have the computer serviced.
The battery-power status indicator has turned off although a fully charged battery pack is installed in the computer.	The over-current protection device inside the battery pack has been activated. Wait for several hours and try to use it again. If there is still a problem, replace the battery pack or have the computer serviced.

What If Your Computer Does Not Work?

Problem	Action
<p>The battery pack cannot be fully charged in 3 hours by the power-off charging method.</p>	<p>The battery pack is over-discharged.</p> <p>Action:</p> <ol style="list-style-type: none"> 1. Turn off the computer. 2. Make sure that the over-discharged battery pack is in the computer. 3. Connect the AC Adapter to the computer and let it charge for approximately 7 hours. <p>If the Quick Charger (available as an option) is available, charge the over-discharged battery pack.</p>
<p>The battery-charging indicator is on, and the battery-power status indicator is blinking.</p>	<p>A problem has occurred during the charging of the battery pack.</p> <p>Check to see if the AC Adapter is correct for your computer.</p> <p>Take the battery pack out of the compartment and let it cool for a while; then charge it again.</p> <p>If there is still a problem, have the computer serviced.</p>
<p>When you use the NiMH battery pack, the battery-power status indicator blinks green, yellow, orange, and then green again.</p>	<p>No battery status information is going from the battery pack to the computer.</p> <p>Check that the storage switch on the battery pack is set to the on position (). If it is set to the off position (O), slide it to on and repeat the discharging and charging procedure several times (see page 98).</p> <p>If the storage switch is set to the on position, take the battery pack out of the compartment and let it cool for a while; then charge it again.</p> <p>If the problem still occurs, slide the storage switch to the off position (O) and then to the on position (). Repeat the discharging and charging procedure several times (see page 98).</p> <p>Notes:</p> <ol style="list-style-type: none"> 1. Use the tip of a ballpoint pen to slide the storage switch to the off position (O) from the on position (). 2. Do <i>not</i> slide the switch to the off position (O) for daily operations of your computer. Otherwise, incorrect battery-power status will be reported. <p>If there is still a problem, have the computer serviced.</p>

Diskette Drive Problems

Problem	Action
The diskette drive in use indicator stays on.	<p>If there is a diskette in the drive, verify that:</p> <ul style="list-style-type: none"> – There is nothing wrong with the diskette. Try a backup copy if you have one. – The diskette is inserted correctly (label up and metal-shutter end first) in the diskette drive. – The diskette contains the necessary files to start the system. – There is nothing wrong with your application program (see page 215). <p>If the preceding items are correct, have the computer serviced.</p> <p>If there is no diskette in the drive, have the computer serviced.</p>

Mwave DSP Feature Problems

Problem	Cause and action
The Sound Blaster support cannot be enabled.	It is probably because Mwave is being used for other functions, such as the modem. Try disabling another function; then type MWGAMES ON MIN . The MIN option will enable Sound Blaster support using the minimum possible amount of Mwave resources.
DOS games work slowly in a Windows session.	Some DOS games run slower in a Windows DOS session than in native DOS. Check the documentation of your game for special instructions about improving performance. Configure Windows to use the VGA display driver rather than a higher resolution or less efficient driver. Determine if your game allows you to turn off “background music” and only play special effects.
The modem does not work correctly.	<p>Verify that:</p> <ul style="list-style-type: none"> The modem/fax port is securely installed. The modem is correctly identified in your communication program. <p>This is often caused by a conflict of the communication port address or interrupt assignments or both.</p>
A Windows error message states that no MIDI device is available.	This is often because of the DSP resources have been used up. Try stopping some application that is using the DSP, and retrying the failing function.
A Windows error message states that no WAV device is available.	This is often because of the DSP resources have been used up. Try stopping some application that is using the DSP, and retrying the failing function.
A modem error occurred.	Refer to the command reference in the Mwave ThinkPad window.
A modem application is not working.	Verify that you have started your modem. Make sure you did not close it instead of minimizing it. Verify that it was set to support the speed you are trying to use.
A speaker phone application does not work.	Verify that you disabled the Audio button in the Audio Control.

What If Your Computer Does Not Work?

Problem	Cause and action
Other problems.	<p>The following is a list of failures that can cause other problems.</p> <ul style="list-style-type: none">A compatibility problem exists between the Mwave feature and one or more other adapters in the system.To isolate a compatibility problem, remove other adapters from your system and rerun the diagnostics while these adapters are removed.The phone cabling configuration is not correct for your application.The phone cabling is defective.The phone is defective.The audio cabling configuration is not correct for your application.The audio cabling is defective.The audio equipment is defective.

Infrared Communication Problems

Problem	Action
The computer cannot communicate with other devices using the infrared port on the computer.	<p>Verify that:</p> <ul style="list-style-type: none">The infrared function is enabled and other choices are set correctly in the ThinkPad Setup menu of the ThinkPad Features program (see page 35).The communicating device is using an equivalent communication speed.The infrared ports are cleaned and no spotty area exist.No cable or electrical device is between the computer and the communicating device.The distance and angle between the computer and the communicating device are correct (see page 72).
Incorrect data is sent between the computer and device.	<p>Verify that:</p> <ul style="list-style-type: none">The distance and angle between the devices are correct (see page 72).The communicating device is using an equivalent communication speed.There is no device radiating infrared rays, such as remote-controlled devices or wireless headphones, near the computer or device.Direct sunlight or fluorescent lamps are not near the computer or device.

What If Your Computer Does Not Work?

Software Problems

Problem	Action
An application program does not work correctly.	<p>To determine if a problem is caused by the software, verify that:</p> <ul style="list-style-type: none">Your computer has the minimum memory required to use the software. Refer to the manuals supplied with the software to verify this.The software is designed to operate with your computer.Other software works correctly with your computer.The software you are using works correctly with another computer. <p>If you have received any error messages when using the application program, refer to the manuals supplied with the software for a description of the messages and a solution to the problem.</p> <p>If the preceding items are correct and there is still a problem, contact your IBM authorized reseller or IBM marketing representative for help.</p>

Option Problems

Problem	Action
An IBM option that was just installed does not work.	<p>Verify that:</p> <ul style="list-style-type: none">The option is designed for the computer.The option has been installed correctly by following the instructions supplied with the option.Other installed options or cables are not loose.No I/O address or interrupt level conflict has occurred. Use the System Info of the ThinkPad Features program. <p>If the test programs for the option did not find the problem, have the computer and option serviced.</p>
An IBM option that used to work no longer works.	<p>Verify that:</p> <ul style="list-style-type: none">All the option hardware and cable connections are securely connected.If the option came with its own test instructions, use those instructions to test the option. <p>If the preceding items are correct and the test programs did not find the problem, have the computer and option serviced.</p>
The serial port does not work.	Ensure that Serial port is set to Serial_1 , Serial_2 , Serial_3 , or Serial_4 in the ThinkPad Features program or Easy-Setup.

What If Your Computer Does Not Work?

Problem	Action
The PC Card does not work.	Verify that: The serial addresses for the serial devices (serial port A, serial port B, infrared ports, and Mwave telephony function) do not conflict with each other. Check them in the ThinkPad Setup menu of the ThinkPad Features program. A serial address is reserved for the PC Card. The PC Card is designed for the computer. The software is suitable for use with the PC Card. See the instructions that came with the PC Card. If the PC Card has its own diagnostic instructions, use those instructions to test it.

Keyboard, External Numeric Keypad, and Pointing Device Problems

Problem	Action
All or some keys on the system keyboard do not work.	If the problem occurs immediately after the computer returns to normal operation from suspend mode, enter the power-on password. If a power-on password is set, you must enter the password. If the external keyboard is connected, the numeric keypad on the system keyboard will not work. If the external numeric keypad or the mouse is connected: <ol style="list-style-type: none">1. Turn off the computer.2. Remove the external numeric keypad or the mouse.3. Turn on the computer and try the keyboard operation again. If the keyboard problem is resolved, check the connection of the external numeric keypad, external keyboard, or the mouse. If there is still a problem, have the computer serviced.
The pointer drifts when the computer is turned on, or after resuming normal operation. —or— During computer operation, the pointer drifts when not using the TrackPoint III.	Drifting is a characteristic of the TrackPoint III and is not a defect. The drifting occurs for several seconds under the following conditions: When the computer is turned on. When resuming normal operation. When the TrackPoint III is pressed for a long period of time. When the environmental temperature changes. Do not touch the TrackPoint III until the pointer stops moving.

What If Your Computer Does Not Work?

Problem	Action
The mouse or pointing device does not work.	<p>Verify that the mouse or pointing-device cable is securely connected to the computer.</p> <p>Try using the TrackPoint III. If the TrackPoint III works, suspect the externally attached pointing device.</p> <p>If you are using Windows, make sure Computer is set as MS-DOS System with APM. See page 177.</p> <p>If you are using mouse that is not compatible with the IBM PS/2 Mouse, disable the TrackPoint III using the ThinkPad Features program.</p> <ol style="list-style-type: none"> 1. For OS/2 and Windows, see page 36. Select Setup, Keyboard/Pointing Device; then click on disable for the TrackPoint III. 2. For DOS, see page 41.
All or some keys on the external numeric keypad do not work.	Verify that the external numeric keypad is correctly connected to the computer.
All or some keys on the external keyboard do not work.	<p>Verify that:</p> <ul style="list-style-type: none"> The keyboard connector is connected to the correct side of the keyboard/mouse connector. The keyboard/mouse connector is correctly connected to the computer. <p>If the preceding items are correct, disconnect the keyboard/mouse connector from the computer and verify that the operation of the system keyboard is correct. If the system keyboard works, have the keyboard/mouse connector or the external keyboard serviced.</p>
A number appears when you type an alphabetic character.	The Numeric Lock indicator is on. Press and hold Shift ; then press NumLk .

What If Your Computer Does Not Work?

External Display Problems

Problem	Action
The screen is blank.	<p>Verify that:</p> <ul style="list-style-type: none">The power cord for the external display is plugged into a working electrical outlet and into the external display.The external display is turned on and the brightness and contrast controls are adjusted.The signal cable for the external display is plugged into the external-display connector on the computer. Some signal cables might not fit into the external-display connector because of the connector type.The external display (CRT) is selected as the display device using the Fn key function (see page 48) or the ThinkPad Features program (see page 35).The suspend option to enter suspend mode when the LCD is closed is disabled. (See Power of ThinkPad Features program on page 37 or type PS C D from the command prompt.) <p>Turn off the computer; then turn it on.</p> <p>If the preceding items are correct and the screen of the external display remains blank, run the display tests described in the instructions supplied with the external display. If the tests show the external display is OK, have the computer serviced.</p>
The screen is unreadable or distorted.	<p>Verify that:</p> <ul style="list-style-type: none">The ThinkPad display driver is installed correctly (see page 188).The Display in the Windows Setup screen is set to your display resolution type (see page 177). <p>To change or set up the external display, see "Attaching an External Display" on page 165.</p> <p>If these are correct, run the tests described in the instructions supplied with the external display. If the tests show the external display is OK, have the computer serviced.</p>
Wrong characters appear on the screen.	<p>Verify that operating systems and application programs have been installed and configured correctly.</p> <p>If so, have the computer serviced.</p>
When you use a DOS application, the screen image appears smaller than the external display size (755CX SVGA model only).	<p>This occurs to maintain the compatibility of DOS application. This is not a problem.</p>

What If Your Computer Does Not Work?

Problem	Action
<p>When you use DOS Shell or some kind of application in the DOS environment, the lines on the screen are disordered. (755CX SVGA model only)</p>	<p>Verify that:</p> <p>If you are using DOS Shell and set the screen mode 800-by-600 resolution by PS2 MODE3X command, do the following:</p> <ol style="list-style-type: none">1. At the DOS Shell screen, select Options from the menu bar; then select Display...2. Select Graphics 30 lines Medium Resolution 1; then select OK. <p>The screen will recover.</p> <p>If you are using other application than DOS Shell, do the following:</p> <ul style="list-style-type: none">– At the DOS command prompt, type PS2 MODE3X OFF; then press Enter.

What If Your Computer Does Not Work?

Printer Problems

Problem	Action
The printer does not work.	<p>Verify that:</p> <ul style="list-style-type: none">The printer is turned on and ready to print.The printer signal cable is connected to the correct connector on the computer. (For the location of the printer connector, see "parallel connector" on page 5.) <p>If the preceding items are correct and the printer still does not work, run the tests described in the printer manual. If the tests show that the printer is OK, have the computer serviced.</p>

Intermittent Problems

Problem	Action
The computer has an intermittent problem.	<p>An intermittent problem can be difficult to find.</p> <ul style="list-style-type: none">Check that all cables and cords are securely connected to the rear of the computer and to the attached options.If the problem occurs only when the computer is powered by a battery pack, replace the battery pack with a fully charged one. <p>If the preceding items are correct and there is still a problem, make a note of the problem and what the computer was doing when the problem occurred. Then contact your IBM authorized reseller or IBM marketing representative for help.</p>

Listing Installed Options

When getting service, you might need to know which options you have in your system. Check or write the names of your options below.

IC DRAM Card (2MB, 4MB, 8MB, or 16MB)	Option in the Diskette Drive Compartment
DIMM (4MB, 8MB, or 16MB)	DIMM Adapter
Internal Diskette Drive	Battery Pack
PC Cards	_____MB Hard Disk Drive

Others

Getting Service

Recording Identification Numbers

The following information is needed when obtaining repair services:

IBM Product Name	ThinkPad 755CX SVGA model ThinkPad 755CX VGA model
Machine Type	_____
Serial Number	_____

The machine type and serial number 1 are located on the bottom of the computer.

The machine type has a prefix of **Type**.

The serial number has a prefix of **S/N**.

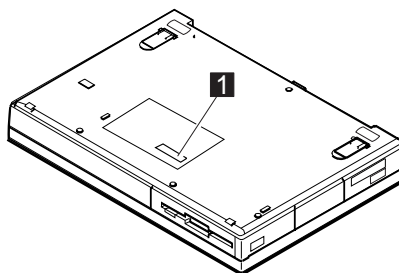

Getting Service

If you need further assistance, call your IBM authorized reseller or IBM marketing representative.

When requesting service, describe the error message or problem to the service representative. Error messages can help identify what service action is required and help the service representative provide quick and efficient service.

Important

During the warranty period, you may be responsible for repair costs if the product damage was due to misuse, accident, modification, unsuitable physical or operating environment, or improper maintenance by you.

For your convenience, write the service phone numbers here.



The IBM HelpClub: Another Great Choice (for European Countries)

Yours for a free trial period.

Helpware

What's great about the HelpClub[†] is that once you're a member you get Helpware[†]. If you intend to use your new ThinkPad at home or for business, Helpware provides a complete range of services designed to help you get the most out of your new computer. If you work for a large company, Helpware can complement your own PC support service—for example, by providing help after your company service has closed down for the day.

When you register, Helpware offers you a full range of services, including the following:

Helpline: helpful advice, day or night

First and foremost, that means you've got access to Helpline — IBM's customer-friendly, round-the-clock technical support and troubleshooting service, available just by your picking up the phone. Complete peace of mind 24 hours a day, 7 days a week, 365 days a year.

Helpware Magazine: hints and tips for all

With your free membership of HelpClub you will receive a free subscription to *Helpware* magazine. We like to say it's one of the best PC magazines around, and you don't have to take our word for it. It has already won two publishing awards and 8 out of 10 HelpClub members tell us it's the only PC magazine they need to read. It's attractively produced, packed with information, and written in plain English, not technical gobbledegook.

HelpClub Privileges: lots of specials for members

HelpClub is an exclusive club for IBM users. You can become a member for a free trial period to receive special offerings.

Helpware is also a source of special deals for IBM customers, comprising an exclusive collection of offers and discounts.

[†] Helpware and the HelpClub offer are subject to continued availability and may vary or may not be offered in all countries. Check with your local IBM office for details.

Getting Service

Join the HelpClub!

Call your country number below during office hours:

Austria	222 21145 7575
Belgium	02/542.5360
Denmark	45 93 45 45 lokal 4600
Finland	9800-6100
France	16-38 55 20 39
Germany	0231-9748-405
Italy	1678 36019
Luxembourg	02/542.5360
Netherlands	020 513 4700
Norway	66 99 95 95
Spain	(91) 563 10 01
Sweden	020-55 55 55
Switzerland	155 46 46
United Kingdom	0628 895222

For other countries: Contact your local IBM office for service information.

Getting Service

Appendix A. Avoiding Hardware Conflicts

When options such as the AT adapter or application programs are installed, the system might not operate correctly because of conflicts in IRQ (interrupt level), I/O addresses, DMA channel, and memory addresses.

To avoid these conflicts, you must be aware of hardware requirements, such as IRQ and I/O addresses, for each option and program as shown in their manuals. You also must check the current resource allocations for the computer and the ThinkPad Dock I or Dock II and select the available resource values.



If you are using OS/2 or Windows, do the following:

- 1** Start the ThinkPad Features program.
- 2** Select **ThinkPad Setup**.
- 3** Select the icon you want to set up in the ThinkPad Setup window.
- 4** Click on the appropriate resources (**IRQ**, **DMA**, or **Memory**) to assign for the device.

These changes will become effective when computer power is turned off and then on again.



When you are using DOS, do the following:

Use the **PS2** command to change the values for devices. Type **PS2 ?** at the command prompt; then press **Enter**.

 **PS2** command:
Page 41.

Avoiding Hardware Conflicts

The following table summarizes the reserved system resources for the computer and the ThinkPad Dock I or Dock II. Values in parentheses are alternative values that are selectable in the ThinkPad Features program, Easy-Setup, or application programs.

System Resources	IRQ	Memory Address (Hex)	I/O Address (Hex)	DMA Channel
Timer	0	None	0040–0043	None
Keyboard	1	None	0060, 0064	None
Serial port 1	4 (or disabled)	None	03F8–03FF (or 02F8–02FF)	None
Serial port 2	3 (or disabled)	None	02F8–02FF (or 03F8–03FF)	None
Serial port 3	4 (or disabled)	None	03E8–03EE (or 02F8–02FF)	None
Serial port 4	3 (or disabled)	None	02E8–02EF (or 03F8–03FF)	None
Parallel port 1	7 (or disabled)	None	03BC–03BE	None
Parallel port 2	7 (or disabled)	None	0378–037A	None
Parallel port 3	5 (or disabled)	None	0278–027A	None
Infrared port	4 (or 3, 5, 10, 11, 15, disabled)	None	01A0–01A7 (or 01B0–01B7, 01C0–01C7, 01D0–01D7) 02E8–02EF (or 03F8–03FF, 02F8–02FF, 03E8–03EF)	0 and 3 or disable
Diskette controller	6	None	03F0–03F7	2
Video controller	9	A0000–BFFFFF	03B4–03B5, 03BA, 03C0–03C9, 03CA, 03CC, 03CE–03CF, 03D4–03D5, 03DA 2DF0, 2DF1, 46E8	None
Mwave DSP device	5 (or 7, 10, 11, 15, disabled)	None	0030, 4E30, BE30, CE30	0 (or 1, 6, 7)
Sound Blaster	7 (or 5, 10, 11, disabled)	None	0220, 0240	0 (or 1, 6, 7)
MIDI	None	None	0300, 0330	None
Modem	3, 4, disabled	None	03F8, 02F8, 03E8, 02E8	None
Hard disk drive	14	None	01F0–01F7, 03F6–03F7	None
PCMCIA controller	None	None	03E0–03E3	None
PC Card	(Depends on the type of PC Card)	C0000–DFFFFF	None	None
Real-time clock	8	None	0070–0071	None
TrackPoint III or mouse	12	None	0060, 0064	None
Math coprocessor exception	13	None	None	None

Avoiding Hardware Conflicts

System Resources	IRQ	Memory Address (Hex)	I/O Address (Hex)	DMA Channel
Options in Dock I or Dock II SCSI controller	2, 3, 4, 5, 7, 9, 10, 11, 15	CA000–CBFFF C8000–C9FFF CE000–CFFFF DE000–DFFFF	(Depends on the installed option device)	0, 1, 2, 3, 5, 6, 7
AD/VC adapter	None	None	92E9	None
<p>Notes:</p> <p>Selected values are assigned to a serial port and a parallel port of the computer. Selectable in the ThinkPad Features program or PS2 command.</p> <p>VL-Bus master is used.</p> <p>The IRQ for PC Card depends on the PC Card type.</p> <p>Selectable in the Resource Map Utility program. See “Software Considerations for DOS” on page 235.</p> <p>Select an IRQ and the memory addresses with a jumper and switch on the main board of Dock I/Dock II. See the <i>Dock I User's Guide</i> or <i>Dock II User's Guide</i>. Do not select Disabled when OS/2 is used.</p> <p>The 755CX SVGA model does not support this option.</p>				

Avoiding Hardware Conflicts

Appendix B. Advanced Information for PC Cards

This appendix describes the Auto Configurator program, which automatically enables the PC Card without the device driver supplied with your PC Card being installed. It also explains some considerations you should be aware of when using your PC Card.

Auto Configurator for the PC Card Director Program



To install the PCMCIA device driver:
Page 183.

The *Auto Configurator* makes it possible for you to avoid installing the device drivers for some PC Cards. When installing an operating system, install the PCMCIA device driver that is on the PCMCIA Features Diskette so you can use the Auto Configurator program.

When Auto Configurator is installed, the following line is added to the CONFIG.SYS file:

For OS/2:

```
DEVICE=[DRIVE][PATH]AUTODRV2.SYS [DRIVE][PATH]AUTODRV2.INI
```

For DOS or Windows:

```
DEVICE=[DRIVE][PATH]AUTODRV.SYS [DRIVE][PATH]AUTODRV.INI
```

The basic structure of the data file for Auto Configurator, AUTODRV2.INI for OS/2 or AUTODRV.INI for DOS or Windows, is as follows:

```
[Card name]
CardID=card name
Keyword1=data1,Keyword2=data2,...
Keyword1=data1,Keyword2=data2,...
Keyword1=data1,Keyword2=data2,...
Keyword1=data1,Keyword2=data2,...
```

Example When a Modem Card Is Used

When a modem card is installed in the PC Card slot, the Auto Configurator assigns interrupt request levels and I/O window from the information in the following data file and tuple data of the modem card:

```
[MODEM]
CardID=MODEM,MD24X
Port1=3F8,IRQ=4
Port1=2F8,IRQ=3
Port1=3E8,IRQ=3
Port1=2E8,IRQ=3
```

Starting from the first "Port1" line, the Auto Configurator tries to assign the resources from I/O window X'3F8' and interrupt request level 4 for the modem. If the Auto Configurator finds resources that are not occupied by the system, it assigns them to the modem. If I/O port address X'3F8' is already occupied by the system serial port, Auto Configurator cannot assign the first "Port1" line ([Port1=3F8,IRQ=4]) to the modem. It would then try to assign the next "Port1" line ([Port1=2F8,IRQ=3]) to the modem.

The CardID parameter is used to identify the modem card that does not contain enough tuple data. If the Auto Configurator cannot recognize the modem card installed into the PC Card slot, you must add the modem card identification indicated in the level 1 version/product information tuple. The identification must be written using up to five uppercase ASCII characters. If you want to display this character string, use the DOS PC Card Utility (EZPLAY.EXE), Windows PC Card Utility (EZPLAY.EXE), or OS/2 PC Card Utility (EZPLAY2.EXE). The preceding example identifies the modem card as "MD24X." Make sure that you include the character strings, following "MODEM." When you use OS/2, you can include up to five character strings, following "MODEM." The Windows PC Card Utility allows you to automatically register the character string by selecting the **Register** button on the *Card Information* screen.

Example When the Auto Configurator Is Not Used

When you do not need to use the Auto Configurator, add the following line after the "CardID" parameter:

```
Option=Ignore
```

The Auto Configurator does not assign resources to the PC Card when this line is added.

Example of the Memory Area for the Card Services and 3270

Notes:

1. The Auto Configurator for OS/2 supports modem and data/fax modem PC Cards.
2. The Auto Configurator for DOS and Windows supports modem, data/fax modem, and 3270 emulation PC Cards.

The following is an example of the memory area specified by the Card Services memory area and 3270 data file:

A Resource Map Utility statement:

```
DEVICE=C:\EZPLAY\DICRMU 1.SYS /MA=D -D7FF
```

Lines from the 3270 data file:

```
[ 327 ]  
CardID=327  
Port1=2D ,IRQ=9 ,Memory1=CE  
Port1=6D ,IRQ=9 ,Memory1=D
```

The keyword "Memory1" is specified by the base address of the memory window given as a hexadecimal segment address. Memory window 1 must be within the range of the memory area reserved for Card Services. The Card Services memory area is specified using the Resource Map Utility.

In the preceding example, the memory area for Card Services is from X'D000' to X'D7FF' and the 3270 memory area is specified by "Memory1" of the data file. The memory area (X'CE00') for "Memory1" in the first "Port1" line is not within the area ("MA=" parameter) specified for the Card Services memory. As a result, the Auto Configurator cannot assign the 3270. It attempts to assign the 3270 from details of the second "Port1" line.

Carefully check each application program you use so that the memory area is specified by the "MA=" parameter.

Operational Considerations for PCMCIA

Consider the following according to your operating system:



Software Considerations for OS/2

The following is a sample of the CONFIG.SYS file for OS/2:

```
:
BASEDEV=PCMCIA.SYS /P ←Rule 1
BASEDEV=ICRMU 1.SYS ←Rule 1
BASEDEV=IBM2SS 1.SYS /D ←Rule 1
DEVICE=C:\OS2\MDOS\VPCMCIA.SYS
DEVICE=C:\THINKPAD\COM.SYS
DEVICE=C:\THINKPAD\AUTODRV2.SYS C:\THINKPAD\AUTODRV2.INI
:
DEVICE=PC_Card_Client_device_driver ←Rule 2
:
DEVICE=C:\THINKPAD\$(ICPMOS2.SYS ←Rule 3
```

You might need to update the CONFIG.SYS file after you have installed the PCMCIA software. If you make any changes to your CONFIG.SYS file, keep in mind the following rules for PCMCIA software:

- Rule 1** The Card Services driver (PCMCIA.SYS) must be listed before any other PCMCIA drivers. The Resource Map Utility (ICRMU01.SYS) and Socket Services driver (IBM2SS01.SYS) must be listed in this order. These modules must be listed just after the Card Services driver.
- Rule 2** The PC Card Client device drivers must be listed after the Socket Services (IBM2SS01.SYS) and before the Power Management Utility (\$ICPMOS2.SYS).
- Rule 3** The Power Management Utility (\$ICPMOS2.SYS) should be listed at the end of the CONFIG.SYS file.

DOS

Software Considerations for DOS

Keep in mind the following considerations when using PC Cards:

Using a Software EMS with the PC Card

To use a software EMS without the Dock I or Dock II:

During the installation of the PCMCIA device driver, your system automatically sets up the memory space so that you can use EMS with a PC Card.

To use a software EMS with an adapter card in the Dock I or Dock II:

You can specify a memory area in your CONFIG.SYS file so that the memory areas for the PC Card, adapter, and EMS do not conflict with one another. To determine the required-memory space of the PC Card, refer to the manual that came with the PC Card. You should allocate at least 34KB of memory to the DOS Card Services (IBMDOSCS.SYS).

The hardware interrupt level of the PC Card and the adapter must be assigned exclusively. To avoid a conflict, use the Resource Map Utility (DICRMU01.SYS) with the following parameters:

```
DEVICE= [drive:] [path] DICRMU 1.SYS
[ [/MA=mmmm-mmmm[, mmmm]] [/IX=IRQ level[, IRQ level]]]
```

/MA= The segment address range that is allocated to the memory window for a PC Card.

mmmm-mmmm

The address range of the PC Card. The range can be specified from X'C000' to X'DFFF'. One or more address ranges can be specified with a comma (,) to separate the address ranges.

/IX=IRQ level

The interrupt request level that *cannot* be used by the PC Card. You can specify levels 3, 4, 5, 7, 9, 10, 11, 12, 14, and 15. One or more of these levels can be specified with a single DEVICE command.

Warning:

When you update the EMM386 parameter in the CONFIG.SYS file using RAMSETUP, set the same address range as the one specified by the "/MA=" parameter of DICRMU01.SYS as "Adapter".

Advanced Information for PC Cards

Note:

The procedure assumes that you are using "EMS386.EXE" as an EMS device driver.

The following example shows the procedure for memory allocation when an adapter that requires 32KB of memory is installed (the required-memory space of the adapter cards might vary from one card to another).

1. Open your CONFIG.SYS file using a text editor.
2. Find the DEVICE statement containing "EMM386.EXE."
3. Change the statement to:

```
DEVICE=C:\DOS\EMM386.EXE 1 24 FRAME=D X=C -C7FF
X=C8 -CFFF
```

4. Find: DEVICE=C:\DICRMU 1.SYS

5. Change this statement to:

```
DEVICE=C:\DICRMU 1.SYS /MA=C8 -CFFF /IX=11
```

6. Save the changes in your CONFIG.SYS file; then restart the system.

Note:

The memory range specified by the "MA=" parameter must be the same as or included in the memory range specified by the "X=" parameter.

Interrupt request level 11 cannot be used by the PC Card. After you complete these steps, the memory map will be as follows:

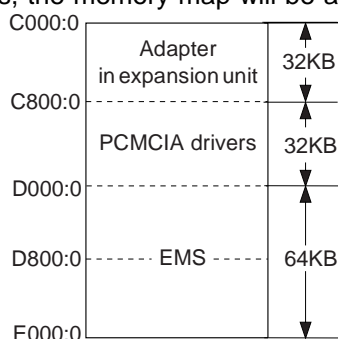

DOS

Examples of Hardware Configurations

The following examples show memory allocations and notices for using various PC Cards:

Using PC Cards and SCSI adapter installed in the Dock I:

- Modify your CONFIG.SYS file as follows:

```
:
DEVICE=C:\DOS\EMM386.EXE NOEMS X=C -CFFF
:
DEVICE=C:\THINKPAD\DICRMU 1.SYS /MA=C -C9FF,CC -CFFF
```

Advanced Information for PC Cards

Note:
For more information, see Chapter 5 of the *Dock I User's Guide*.

This maximizes the memory address range that is allocated for the PC Cards and SCSI adapter in the Dock I. This assumes the Dock I SCSI adapter is at the default allocation (X'CA000'—X'CBFFF').

Using several PC Cards

- Modify the configuration file as in the following example (IBM token ring card + IBM Ethernet card + IBM 3270 card + modem + EMM386):

```
< CONFIG.SYS >

DEVICE=C:\DOS\EMM386.EXE NOEMS X=C3 -CFFF ← modified
:
DEVICE=C:\THINKPAD\IBMDSS 1.SYS
DEVICE=C:\THINKPAD\IBMDOSCS.SYS
DEVICE=C:\THINKPAD\DICRMU 1.SYS /MA=C3 -CFFF ← modified
DEVICE=C:\THINKPAD\$ICPMDOS.SYS
DEVICE=C:\DOS\POWER.EXE
DEVICE=C:\THINKPAD\AUTODRV.SYS C:\THINKPAD\AUTODRV.INI
DEVICE=C:\THINKPAD\DISKDRV.SYS
:
:
DEVICE=C:\LSP\PROTMAN.DOC /I:C:\LSP ← LSP adds this line
DEVICE=C:\LSP\PCMNICCS.DOC ← LSP adds this line
DEVICE=C:\LSP\IBMTOKCS.DOC ← LSP adds this line
DEVICE=C:\LSP\DXMA MOD.SYS 1 ← LSP adds this line
DEVICE=C:\LSP\DXME MOD.SYS ← LSP adds this line
DEVICE=C:\LSP\DXMT MOD.SYS O=N ← LSP adds this line
: (LSP: LAN Support Program)

< PROTOCOL.INI (C:\LSP\PROTOCOL.INI) >

[IBMTOKCS_NIF]
:
RAM = Xc4 ← modified
RAMSIZE = 16
:
MMIO = Xcc ← modified

[PCMNICCS_NIF]
:
RAM = Xc8 ← modified
:
```

Advanced Information for PC Cards

For the preceding example, the memory map will be as follows:

C000:0	EMS memory
C300:0	
C400:0	IBM Card Services
C800:0	Token-ring shared RAM
CC00:0	Ethernet shared RAM
CE00:0	Token-ring memory mapped I/O
D000:0	3270 shared RAM
E000:0	EMS memory

DOS

Updating the CONFIG.SYS File

The following is a sample of the CONFIG.SYS file for DOS:

```
:
DEVICE=C:\DOS\EMM386.EXE RAM 1 24 frame=D X=C8 -CFFF ←Rule 1
:
DEVICE=C:\THINKPAD\IBMDSS 1.SYS /D ←Rule 2
DEVICE=C:\THINKPAD\IBMDOSCS.SYS ←Rule 2
DEVICE=C:\THINKPAD\DICRMU 1.SYS /MA=C8 -CFFF ←Rule 2
DEVICE=C:\THINKPAD\ICPMDOS.SYS ←Rule 2
DEVICE=C:\THINKPAD\AUTODRV.SYS C:\THINKPAD\AUTODRV.INI
DEVICE=C:\THINKPAD\DISKDRV.SYS
DEVICE=C:\DOS\POWER.EXE ←Rule 3
:
DEVICE=PC_Card_Client_device_driver ←Rule 4
```

You might need to update the CONFIG.SYS file after you have installed the PCMCIA software. If you make any changes to your CONFIG.SYS file, keep in mind the following rules for PCMCIA software:

Advanced Information for PC Cards

- Rule 1** For you to use the software EMS driver (EMM386.EXE) with the PCMCIA drivers, the “X=” parameter must be specified for EMM386.EXE. This parameter specifies the memory range that is used by the PCMCIA drivers. (For more information see “Using a Software EMS with the PC Card” on page 235.)
- Rule 2** The Socket Services driver (IBMDSS01.SYS), Card Services driver (IBMDOSCS.SYS), Resource Map Utility (DICRMU01.SYS), and Power Management Utility (\$ICPMDOS.SYS) must be listed in this order.
- Rule 3** The Advanced Power Management driver (POWER.EXE) must be specified in the CONFIG.SYS file. This is installed with DOS.
- Rule 4** The PC Card Client device drivers must be listed after all other PCMCIA drivers.

If you do not use the PC Card and need more application memory area, see “Releasing the PCMCIA Memory Area” on page 240.

Advanced Information for PC Cards

DOS

Releasing the PCMCIA Memory Area

Note:
These procedures do not apply to the device drivers supplied with your PC Card.

If you are using DOS 7.0 or later but not are using the PC Card, you can use the PCMCIA memory area as your application program memory area. There are two ways to make this available for application programs:

- Use the PCMCIAOF command.
- Use the DOS Multiple Configuration Function.

Using the PCMCIAOF command: Type **PCMCIAOF** at the command prompt (usually C:>). This converts the PCMCIA DEVICE statements to comments.

The CONFIG.SYS file will look like this:

```
DEVICE=C:\DOS\EMM386.EXE 1 24 frame=D X=C8 -CFFF
:
REM DEVICE=C:\THINKPAD\IBMDSS 1.SYS /D
REM DEVICE=C:\THINKPAD\IBMDOSCS.SYS
REM DEVICE=C:\THINKPAD\DICRMU 1.SYS /MA=C8 -CFFF
REM DEVICE=C:\THINKPAD\ICPMDOS.SYS
REM DEVICE=C:\THINKPAD\AUTODRV.SYS C:\THINKPAD\AUTODRV.INI
REM DEVICE=C:\THINKPAD\DISKDRV.SYS
DEVICE=C:\DOS\POWER.EXE
:
DEVICE=PC_Card_Client_device_driver
```

If you want to reset the PCMCIA memory area so you can use a PC Card, enter **PCMCIAON** at the command prompt.

Advanced Information for PC Cards

Note:

See the sections in the *DOS User's Guide* about using the DOS operating system and configuring your system using multiple configurations for more information about the DOS Multiple Configuration Function.

Using the DOS Multiple Configuration Function: Use the DOS Multiple Configuration Function to change the CONFIG.SYS file, and add the choice of loading the PCMCIA device driver.

The CONFIG.SYS file should look like this:

```
[MENU]
MENUITEM=DLS, Load DOS LAN Services Client
MENUITEM=INTLNK, Load InterLnk Client
MENUITEM=CPSW, Load Code Page Switching
MENUITEM=PCMCIA, Load IBM PCMCIA drivers
MENUCOLOR=7,1
MENUDEFAULT=DLS,2
:
[COMMON]
DEVICE=C:\DOS\HIMEM.SYS
DEVICE=C:\DOS\EMM386.EXE ....
:
[DLS]
DEVICEHIGH=C:\NET\protman.dos /i:C:\NET
DEVICEHIGH=C:\NET\dlshep.sys
DEVICEHIGH=C:\NET\ibmtok.dos

[INTLNK]
DEVICEHIGH=C:\DOS\INTERLNK.EXE

[PCMCIA]
DEVICE=C:\THINKPAD\IBMDSS 1.SYS /D
DEVICE=C:\THINKPAD\IBMDOSCS.SYS
DEVICE=C:\THINKPAD\DICRMU 1.SYS /MA=C8 -CFFF
DEVICE=C:\THINKPAD\$ICPMDOS.SYS
DEVICE=C:\THINKPAD\AUTODRV.SYS C:\THINKPAD\AUTODRV.INI
DEVICE=C:\THINKPAD\DISKDRV.SYS

[COMMON]
DEVICEHIGH=C:\DOS\ANSI.SYS
SHELL=C:\DOS\COMMAND.COM /P /E:512
:
```



Software Considerations for Windows

If you are using Windows, specify the memory area for Windows so it does not conflict with the memory area for the PCMCIA device drivers. After completing the installation for Windows, update your SYSTEM.INI file as follows:

1. Open your CONFIG.SYS file using a text editor.
2. Find:

```
DEVICE= [drive:][path] DICRMU 1.SYS /MA=mmmm-mmmm
```

3. Note the address range of the PCMCIA device drivers (*mmmm-mmmm*); then close the CONFIG.SYS file and open the SYSTEM.INI file of Windows.
4. Add the following line to the [386Enh] section of the SYSTEM.INI file:

```
EMMEXCLUDE=mmmm-mmmm
```

The parameters for "/MA" and "EMMEXCLUDE" must be the same.

5. Close the SYSTEM.INI file.

Appendix C. Additional Information for Mwave DSP Feature

Note:
In some countries, the Mwave telephony functions are available only after the DAA/Telephony Kit option is installed.

This appendix provides detailed information about the ThinkPad Mwave DSP Features.

Audio Information

This section provides information about the ThinkPad audio features.

Sound

The Mwave DSP features provide support for Windows Version 3.11 audio applications that comply with the Windows MultiMedia Extensions (MME) for audio, for example, Windows Sound Recorder and Windows Media Player that are shipped with Windows Version 3.11.

In general, recording audio music and speech at higher quality requires more disk storage. The following table shows some typical values for various sampling rates:

Sample Rate	Sample Size	Frequency Range	Signal/Noise Ratio	Remarks
44.1 KHz	16 bits	20 Hz — 20 KHz	80 dB	CD quality
22.05 KHz	16 bits	20 Hz — 10 KHz	80 dB	< CD quality
11 KHz	16 bits	20 Hz — 5 KHz	80 dB	AM quality
9.6 KHz	14 bits	200 Hz — 4 KHz	60 dB	Toll quality
8.0 KHz	8 bits	200 Hz — 4 KHz	60 dB	Toll quality

Mwave MIDI Overview

Mwave MIDI Synthesizer Overview

The Mwave audio features can be a music synthesizer, creating realistic instrument sounds from a sequence of MIDI commands. The MIDI standard defines a very compact representation for music. MIDI is composed of a sequence of commands representing musical events, such as a key press on a music keyboard.

The Mwave Windows Audio Device Driver provides a sampled sound MIDI synthesizer that exceeds the Base Multitimbral requirements of the MPC 1 and MPC 2 specifications.

The Mwave synthesizer is enhanced with a QSound** process. QSound is a signal processing technique used to deceive the acoustic response system (hearing) of a listener. Audio from a stereo speaker system that has been processed by QSound can give the listener the perception that the speakers are displaced much further to the listener's left and right than they actually are.

This is particularly useful for a personal computer system, in which table space is limited, and a small set of speakers are located immediately adjacent to the computer. The angular displacement of the speakers to the listener's left and right is ordinarily not enough to produce a decent stereo effect. But with QSound processing, the listener can perceive sound coming from a variety of directions, some of which are significantly further to the left and right than the actual location of the speakers. The net result is a significantly improved stereo effect.

To optimize the QSound effect, sit directly in front of the computer with the speakers equally distant from both sides of the computer.

Understanding the MIDI Mapper

The MIDI Mapper is a program included with Microsoft Windows that interacts with the Mwave Windows Synthesizer Device Driver to control the way sounds are created on your Mwave feature. In Windows MIDI applications allowing you to specify a MIDI output device, select the Windows MIDI Mapper as the output device rather than sending output to the Mwave driver directly.

The MIDI Mapper controls which of the 16 MIDI channels to send to the Mwave feature for playback. The MPC audio specification describes two types of synthesizers. A BASE Multitimbral synthesizer transmits data on MIDI channels 13–16 and supports 8

Advanced Information for Audio Function

simultaneous voices (8 notes at once, each of which can come from a different instrument). An EXTENDED Multitimbral synthesizer transmits data on MIDI channels 1–10 and supports 32 simultaneous voices.

The Mwave feature supplies the following MIDI Mappers for selecting which MIDI format to use for Mwave:

Mwave EXT GM For Mwave MIDI synthesizer channels 1–10

Mwave Base GM For Mwave MIDI synthesizer channels 13–16

The MPC standard requires authors to provide two versions of every MIDI composition stored in the same file. Channels 1–10 hold the version written for Extended Multitimbral synthesizers, whereas channels 13–16 hold the version written for Base Multitimbral synthesizers.

Most MIDI files included with Windows applications follow this standard of containing two versions of each composition. This is why the Mwave MIDI synthesizer comes with both Base and Extended MIDI Mapper setups. If all channels were played at once, both versions of a MIDI composition would play at the same time. The Mwave Windows synthesizer usually sounds best when the Mwave EXT GM setup is selected in the MIDI Mapper.

If you have a MIDI file that is not producing sound on your Mwave feature, MIDI commands may be being sent on a set of channels the MIDI Mapper is not responding to. Try using the Windows MIDI Mapper to switch the setup between Mwave Base and Mwave Extended Multitimbral modes. This lets you see if the MIDI commands in the file are provided for only one of the two modes.

Other MIDI Controls

The Mwave feature's MIDI synthesizer recognizes several types of control information in the MIDI data stream:

Key velocity The harder the key is pressed, the louder the note sounds.

Main volume This is usually controlled by a knob on a MIDI keyboard. It is received on control number 7.

Pitch bend This can be used to mimic the sound of a whammy bar on a guitar and is usually controlled by a thumb wheel on a MIDI keyboard. Note pitch can be varied ± 2 semitones.

Advanced Information for Audio Function

- Pan** The Mwave feature's MIDI synthesizer uses QSound to implement pan. By using QSound, the position of each channel's instrument is not limited by the position of the speakers. It is received on control number 10.
- Vibrato** Also referred to as *modulation*, this control produces rapid, small changes in the pitch of a note and is usually controlled by a thumb wheel on a MIDI keyboard. Vibrato depth can be varied ± 2 semitones. It is received on control number 1.
- Sustain** Each note of an instrument has an envelope that describes the loudness of the note during attack, decay, sustain, and release periods. Some MIDI keyboards can be used with a pianolike sustain pedal that prolongs the sustain period to mimic holding a note. It is received on control number 64.

Additional Information for Telephony Function

Telephony Information

This section provides additional information about the ThinkPad telephony features.

United States Telephone Consumer Protection Act of 1991 (Facsimile Devices)

The Telephone Consumer Protection Act of 1991 makes it unlawful for any person to use a computer or other electronic device to send any message via a telephone facsimile machine unless such message clearly contains, in a margin at the top or bottom of each transmitted page or on the first page of the transmission, the date and time it is sent and an identification of the business, other entity, or individual sending the message and the telephone number of the sending machine or such business, other entity, or individual.

In order to program this information into your facsimile, you should refer to the accompanying fax software package.

Additional Information for Telephony Function

Appendix D. Features and Specifications

This appendix describes features and specifications for the computer. For more information, refer to the *Technical Reference* manual.

Features

Microprocessor

Intel** Pentium** Processor 75MHz
256KB external cache memory

Memory

Onboard (built-in): 8MB RAM

Optional:

- 2MB, 4MB, 8MB, and 16MB IC DRAM cards
- 4MB, 8MB, and 16MB DIMMs with DIMM adapter

Storage devices

2.5-inch removable hard disk drive
3.5-inch removable diskette drive

Display

TFT color LCD, supporting up to 65 536 colors

10.4 inches (when measured diagonally)

SVGA (800-by-600 resolution) on the LCD of the 755CX SVGA model, or VGA (640-by-480) on the LCD of the 755CX VGA model

SVGA (1024-by-768 and 800-by-600 resolution) on the external display

Brightness control

Keyboard

84-key, 85-key, or 89-key

TrackPoint III

Fn key function

External interface

Serial connector (EIA-RS232D)

Parallel connector (Centronics)

External input-device connector

External-display connector

Features and Specifications

PCMCIA slots (accept two Type I or Type II PC Cards, or one Type III PC Card)

Headphone jack

Microphone/line-in jack (supports a dynamic microphone or a self-battery-powered condenser microphone)

Fax/modem port (in some countries, available as an option)

Infrared ports

System bus

240-pin, 16-bit AT bus connector

Specifications

Size

Width: 297 mm (11.7 in.)
Depth: 210 mm (8.3 in.)
Height: 49.8 mm (1.96 in.)

Weight

Minimum configuration with:
lithium ion battery pack: approximately 2.75 kg (6.1 lb)
NiMH battery pack: approximately 2.9 kg (6.4 lb)

Environment

Temperature (under altitudes of 2438 m (8000 ft)):

- Operating¹ 5° to 35°C (41° to 95°F)
- Operating² 10° to 35°C (50° to 95°F)
- Non-operating: 5° to 43°C (41° to 109°F)

Relative Humidity:

- Operating¹ 8% to 95%
- Operating² 8% to 80%

Maximum altitude: 3048 m (10 000 ft)³

- Maximum temperature at 3048 m (10 000 ft): 31.3°C (88° F)

Heat output

Approximately 136.5 British thermal units (BTUs) per hour (35.0 watts)

Electrical (AC Adapter)

Sine-wave input, at 50 to 60 Hz, is required

The input rating of the AC Adapter: 100–240 V ac, 50/60 Hz.

Battery pack

Lithium ion battery pack:

- Nominal voltage: 10.8 V dc
- Capacity: 2.8 AH

NiMH battery pack:

- Nominal voltage: 8.4 V dc
- Capacity: 3.5 AH

Note:

When you charge the lithium ion battery pack, its temperature must be at least 10°C (50°F).

¹ With no diskette in drive.

² With diskette in drive.

³ With no pressurized condition.

Features and Specifications

IBM Power Cords

For your safety, IBM provides a power cord with a grounded attachment plug to use with this IBM product. To avoid electrical shock, always use the power cord and plug with a properly grounded outlet.

IBM power cords used in the United States and Canada are listed by Underwriters Laboratory (UL) and certified by the Canadian Standards Association (CSA).

For units intended to be operated at 115 volts: Use a UL-listed and CSA-certified cord set consisting of a minimum 18 AWG, Type SVT or SJT, three-conductor cord, a maximum of 15 feet in length and a parallel blade, grounding-type attachment plug rated 15 amperes, 125 volts.

For units intended to be operated at 230 volts (in the U.S.): Use a UL-listed and CSA-certified cord set consisting of a minimum 18 AWG, Type SVT or SJT, three-conductor cord, a maximum of 15 feet in length and a tandem blade, grounding-type attachment plug rated 15 amperes, 250 volts.

For units intended to be operated at 230 volts (outside the U.S.): Use a cord set with a grounding-type attachment plug rated 15 amperes (minimum), 250 volts. The cord set should be marked <HAR> and have the appropriate safety approvals for the country in which the equipment will be installed.

IBM power cords for a specific country are usually available only in that country:

Features and Specifications

IBM Power Cord Part Number	Used in These Countries
25H2205	Argentina, Australia, New Guinea, New Zealand, Papua, Paraguay, Uruguay
25H2207	Bahamas, Barbados, Bermuda, Bolivia, Canada, Cayman Islands, Colombia, Costa Rica, Dominican Republic, Ecuador, El Salvador, Guatemala, Guyana, Haiti, Honduras, Jamaica, Korea (South), Mexico, Netherlands Antilles, Nicaragua, Panama, Peru, Philippines, Saudi Arabia, Suriname, Taiwan, Trinidad (West Indies), United States of America, Venezuela
25H2219	Thailand
25H2209	Austria, Belgium, Bulgaria, Czech Republic, Egypt, Finland, France, Germany, Greece, Hungary, Iceland, Indonesia, Netherlands, Norway, Poland, Portugal, Romania, Slovakia, Spain, Sweden, Turkey, former Yugoslavia
25H2211	Denmark
25H2213	Bangladesh, Pakistan, South Africa, Sri Lanka
25H2215	Abu Dhabi, Albania, Antigua, Bahrain, Brunei, Dubai, Fiji, Hong Kong, India, Ireland, Kenya, Kuwait, Macao, Malaysia, Nigeria, Oman, People's Republic of China, Qatar, Singapore, United Kingdom
25H2221	Switzerland
25H2223	Chile, Italy
25H2225	Israel
85G6665	Japan (2-pin)

Features and Specifications

Diskette Standards

To get the best performance from your diskette drives, use high-quality diskettes (such as IBM diskettes) that meet or exceed the following standards:

1MB, 3.5-inch, unformatted diskette:

ANSI (American National Standards Institute) X3.137
ISO (International Standards Organization) 8860
ECMA (European Computer Manufacturers Association) 100

2MB, 3.5-inch, unformatted diskette:

ANSI X3.171
ISO 9529
ECMA 125

4MB, 3.5-inch, unformatted diskette:

ANSI Standard (under proposal at the time of printing)
ISO 10994 (Type 303)
ECMA 147

Note:

In some country, 4MB diskettes can be used when the diskette drive option is installed.

Appendix E. Product Warranties and Notices

International Business Machines Corporation

Armonk, New York 10504

Statement of Limited Warranty

The warranties provided by IBM in this Statement of Limited Warranty apply only to Machines you originally purchase for your use, and not for resale, from IBM or an IBM authorized reseller. The term "Machine" means an IBM machine, its features, conversions, upgrades, elements, or accessories, or any combination of them. Machines are subject to these terms only if purchased in the United States or Puerto Rico, or Canada, and located in the country of purchase. If you have any questions, contact IBM or your reseller.

Machine: IBM ThinkPad 755CX except the Battery Pack

Warranty Period*: Three Years

**Elements and accessories are warranted for three months. Contact your place of purchase for warranty service information.*

Production Status

Each Machine is manufactured from new parts, or new and serviceable used parts (which perform like new parts). In some cases, the Machine may not be new and may have been previously installed. Regardless of the Machine's production status, IBM's warranty terms apply.

The IBM Warranty

IBM warrants that each Machine 1) is free from defects in materials and workmanship and 2) conforms to IBM's Official Published Specifications. IBM calculates the expiration of the warranty period from the Machine's Date of Installation. The date on your receipt is the Date of Installation, unless IBM or your reseller informs you otherwise.

During the warranty period, IBM or your reseller will provide warranty service under the type of service designated for the Machine and will manage and install engineering changes that apply to the Machine. IBM or your reseller will specify the type of service.

For a feature, conversion, or upgrade, IBM or your reseller may require that the Machine on which it is installed be 1) the designated, serial-numbered Machine and 2) at an engineering-change level compatible with the feature, conversion, or upgrade. Some of these transactions (called "Net-Priced" transactions) may include additional parts and associated replacement parts that are provided on an exchange basis. All removed parts become the property of IBM and must be returned to IBM.

Replacement parts assume the remaining warranty of the parts they replace.

If a Machine does not function as warranted during the warranty period, IBM or your reseller will repair or replace it (with a Machine that is at least functionally equivalent) without charge. If IBM or your reseller is unable to do so, you may return it to your place of purchase and your money will be refunded.

If you transfer a Machine to another user, warranty service is available to that user for the remainder of the warranty period. You should give your proof of purchase and this Statement to that user.

Warranty Service

To obtain warranty service for the Machine, you should contact your reseller or call IBM. In the United States, call IBM at **1-800-772-2227**. In Canada, call IBM at **1-800-565-3344**. You may be required to present proof of purchase.

Depending on the Machine, the service may be 1) a "Repair" service at your location (called "On-site") or at one of IBM's or a reseller's service locations (called "Carry-in") or 2) an "Exchange" service, either On-site or Carry-in.

Warranties and Notices

When a type of service involves the exchange of a Machine or part, the item IBM or your reseller replaces becomes its property and the replacement becomes yours. The replacement may not be new, but will be in good working order and at least functionally equivalent to the item replaced.

It is your responsibility to:

1. obtain authorization from the owner (for example, your lessor) to have IBM or your reseller service a Machine that you do not own;
2. where applicable, before service is provided —
 - a) follow the problem determination, problem analysis, and service request procedures that IBM or your reseller provide,
 - b) secure all programs, data, and funds contained in a Machine,
 - c) inform IBM or your reseller of changes in a Machine's location, and
 - d) for a Machine with exchange service, remove all features, parts, options, alterations, and attachments not under warranty service. Also, the Machine must be free of any legal obligations or restrictions that prevent its exchange; and
3. be responsible for loss of, or damage to, a Machine in transit when you are responsible for the transportation charges.

Extent of Warranty

IBM does not warrant uninterrupted or error-free operation of a Machine.

Misuse, accident, modification, unsuitable physical or operating environment, improper maintenance by you, or failure caused by a product for which IBM is not responsible may void the warranties.

THESE WARRANTIES REPLACE ALL OTHER WARRANTIES, EXPRESS OR IMPLIED, INCLUDING, BUT NOT LIMITED TO, THE IMPLIED WARRANTIES OF MERCHANTABILITY AND FITNESS FOR A PARTICULAR PURPOSE. HOWEVER, SOME LAWS DO NOT ALLOW THE EXCLUSION OF IMPLIED WARRANTIES. IF THESE LAWS APPLY, THEN ALL EXPRESS AND IMPLIED WARRANTIES ARE LIMITED IN DURATION TO THE WARRANTY PERIOD. NO WARRANTIES APPLY AFTER THAT PERIOD.

In Canada, warranties include both warranties and conditions.

Some jurisdictions do not allow limitations on how long an implied warranty lasts, so the above limitation may not apply to you.

Limitation of Liability

Circumstances may arise where, because of a default on IBM's part (including fundamental breach) or other liability (including negligence and misrepresentation), you are entitled to recover damages from IBM. In each such instance, regardless of the basis on which you are entitled to claim damages, IBM is liable only for:

1. bodily injury (including death), and damage to real property and tangible personal property; and
2. the amount of any other actual loss or damage, up to the greater of \$100,000 or the charge for the Machine that is the subject of the claim.

Under no circumstances is IBM liable for any of the following:

1. third-party claims against you for losses or damages (other than those under the first item listed above);
2. loss of, or damage to, your records or data; or
3. economic consequential damages (including lost profits or savings) or incidental damages, even if IBM is informed of their possibility.

Some jurisdictions do not allow the exclusion or limitation of incidental or consequential damages, so the above limitation or exclusion may not apply to you.

Warranties and Notices

This warranty gives you specific legal rights and you may also have other rights which vary from jurisdiction to jurisdiction.

Warranties and Notices

International Business Machines Corporation

Armonk, New York, 10504

Statement of Limited Warranty

The warranties provided by IBM in this Statement of Limited Warranty apply only to Machines you originally purchase for your use, and not for resale, from IBM or an IBM authorized reseller. The term "Machine" means an IBM machine, its features, conversions, upgrades, elements, or accessories, or any combination of them. Machines are subject to these terms only if purchased in the United States or Puerto Rico, or Canada, and located in the country of purchase. If you have any questions, contact IBM or your reseller.

Machine: Battery Pack

Warranty Period*: One Year

**Elements and accessories are warranted for three months. Contact your place of purchase for warranty service information.*

Production Status

Each Machine is manufactured from new parts, or new and serviceable used parts (which perform like new parts). In some cases, the Machine may not be new and may have been previously installed. Regardless of the Machine's production status, IBM's warranty terms apply.

The IBM Warranty

IBM warrants that each Machine 1) is free from defects in materials and workmanship and 2) conforms to IBM's Official Published Specifications. IBM calculates the expiration of the warranty period from the Machine's Date of Installation. The date on your receipt is the Date of Installation, unless IBM or your reseller informs you otherwise.

During the warranty period, IBM or your reseller will provide warranty service under the type of service designated for the Machine and will manage and install engineering changes that apply to the Machine. IBM or your reseller will specify the type of service.

For a feature, conversion, or upgrade, IBM or your reseller may require that the Machine on which it is installed be 1) the designated, serial-numbered Machine and 2) at an engineering-change level compatible with the feature, conversion, or upgrade. Some of these transactions (called "Net-Priced" transactions) may include additional parts and associated replacement parts that are provided on an exchange basis. All removed parts become the property of IBM and must be returned to IBM.

Replacement parts assume the remaining warranty of the parts they replace.

If a Machine does not function as warranted during the warranty period, IBM or your reseller will repair or replace it (with a Machine that is at least functionally equivalent) without charge. If IBM or your reseller is unable to do so, you may return it to your place of purchase and your money will be refunded.

If you transfer a Machine to another user, warranty service is available to that user for the remainder of the warranty period. You should give your proof of purchase and this Statement to that user.

Warranty Service

To obtain warranty service for the Machine, you should contact your reseller or call IBM. In the United States, call IBM at **1-800-772-2227**. In Canada, call IBM at **1-800-565-3344**. You may be required to present proof of purchase.

Depending on the Machine, the service may be 1) a "Repair" service at your location (called "On-site") or at one of IBM's or a reseller's service locations (called "Carry-in") or 2) an "Exchange" service, either On-site or Carry-in.

Warranties and Notices

When a type of service involves the exchange of a Machine or part, the item IBM or your reseller replaces becomes its property and the replacement becomes yours. The replacement may not be new, but will be in good working order and at least functionally equivalent to the item replaced.

It is your responsibility to:

1. obtain authorization from the owner (for example, your lessor) to have IBM or your reseller service a Machine that you do not own;
2. where applicable, before service is provided —
 - a) follow the problem determination, problem analysis, and service request procedures that IBM or your reseller provide,
 - b) secure all programs, data, and funds contained in a Machine,
 - c) inform IBM or your reseller of changes in a Machine's location, and
 - d) for a Machine with exchange service, remove all features, parts, options, alterations, and attachments not under warranty service. Also, the Machine must be free of any legal obligations or restrictions that prevent its exchange; and
3. be responsible for loss of, or damage to, a Machine in transit when you are responsible for the transportation charges.

Extent of Warranty

IBM does not warrant uninterrupted or error-free operation of a Machine.

Misuse, accident, modification, unsuitable physical or operating environment, improper maintenance by you, or failure caused by a product for which IBM is not responsible may void the warranties.

THESE WARRANTIES REPLACE ALL OTHER WARRANTIES, EXPRESS OR IMPLIED, INCLUDING, BUT NOT LIMITED TO, THE IMPLIED WARRANTIES OF MERCHANTABILITY AND FITNESS FOR A PARTICULAR PURPOSE. HOWEVER, SOME LAWS DO NOT ALLOW THE EXCLUSION OF IMPLIED WARRANTIES. IF THESE LAWS APPLY, THEN ALL EXPRESS AND IMPLIED WARRANTIES ARE LIMITED IN DURATION TO THE WARRANTY PERIOD. NO WARRANTIES APPLY AFTER THAT PERIOD.

In Canada, warranties include both warranties and conditions.

Some jurisdictions do not allow limitations on how long an implied warranty lasts, so the above limitation may not apply to you.

Limitation of Liability

Circumstances may arise where, because of a default on IBM's part (including fundamental breach) or other liability (including negligence and misrepresentation), you are entitled to recover damages from IBM. In each such instance, regardless of the basis on which you are entitled to claim damages, IBM is liable only for:

1. bodily injury (including death), and damage to real property and tangible personal property; and
2. the amount of any other actual loss or damage, up to the greater of \$100,000 or the charge for the Machine that is the subject of the claim.

Under no circumstances is IBM liable for any of the following:

1. third-party claims against you for losses or damages (other than those under the first item listed above);
2. loss of, or damage to, your records or data; or
3. economic consequential damages (including lost profits or savings) or incidental damages, even if IBM is informed of their possibility.

Some jurisdictions do not allow the exclusion or limitation of incidental or consequential damages, so the above limitation or exclusion may not apply to you.

Warranties and Notices

This warranty gives you specific legal rights and you may also have other rights which vary from jurisdiction to jurisdiction.

Notices

References in this publication to IBM products, programs, or services do not imply that IBM intends to make these available in all countries in which IBM operates. Any reference to an IBM product, program, or service is not intended to state or imply that only that IBM product, program, or service may be used. Any functionally equivalent product, program, or service that does not infringe any of the intellectual property rights of IBM may be used instead of the IBM product, program, or service. The evaluation and verification of operation in conjunction with other products, except those expressly designated by IBM, are the responsibility of the user.

IBM may have patents or pending patent applications covering subject matter in this document. The furnishing of this document does not give you any license to these patents. You can send license inquiries, in writing, to the IBM Director of Licensing, IBM Corporation, 500 Columbus Avenue, Thornwood, NY 10594, U.S.A.

Trademarks

The following terms, used in this publication, are trademarks of the IBM Corporation in the United States or other countries or both:

AT	OS/2
IBM	PS/2
MMPM/2	ThinkPad
Multimedia Presentation Manager/2	TrackPoint III
Mwave	WIN-OS/2
Operating System/2	

The following terms, denoted by a double asterisk (**) in this publication, are trademarks of other companies as follows:

100LX	Hewlett-Packard Company
200LX	Hewlett-Packard Company
America Online	America Online, Inc.
Bell	AT&T Bell Laboratories
Centronics	Centronics Data Computer Corp.
CompuServe	CompuServe, Inc.
Hayes	Hayes Microcomputer Products, Inc.
Hewlett-Packard	Hewlett-Packard Company
Intel	Intel Corporation
Kensington	Kensington Microware Ltd.
MCI	Microsoft Corporation
MicroCom	MicroCom Corporation
MicroSaver	Kensington Microware Ltd.
Microsoft	Microsoft Corporation
MNP	MicroCom Corporation
MS-DOS	Microsoft Corporation
Omnibook	Hewlett-Packard Company
PCMCIA	Personal Computer Memory Card International Association

Warranties and Notices

Pentium	Intel Corporation
Phoenix	Phoenix Technologies, Ltd.
PRODIGY	Prodigy Services, Inc.
QSound	QSound, Inc.
Sharp	Sharp Corporation
Sound Blaster	Creative Labs, Inc.
UL	Underwriters Laboratory
Western Digital	Western Digital Corporation
Windows	Microsoft Corporation
Wizard	Sharp Corporation

Electronic Emission Notice

Federal Communications Commission (FCC) Statement

Part 15 of the FCC Rules

Note: This equipment has been tested and found to comply with the limits for a Class B digital device, pursuant to Part 15 of the FCC Rules. These limits are designed to provide reasonable protection against harmful interference in a residential installation. This equipment generates, uses, and can radiate radio frequency energy and, if not installed and used in accordance with the instructions, may cause harmful interference to radio communications. However, there is no guarantee that interference will not occur in a particular installation. If this equipment does cause harmful interference to radio or television reception, which can be determined by turning the equipment off and on, the user is encouraged to try to correct the interference by one or more of the following measures:

- Reorient or relocate the receiving antenna.
- Increase the separation between the equipment and receiver.
- Connect the equipment into an outlet on a circuit different from that to which the receiver is connected.
- Consult an IBM authorized dealer or service representative for help.

Properly shielded and grounded cables and connectors must be used in order to meet FCC emission limits. Proper cables and connectors are available from IBM authorized dealers. IBM is not responsible for any radio or television interference caused by using other than recommended cables and connectors or by unauthorized changes or modifications to this equipment. Unauthorized changes or modifications could void the user's authority to operate the equipment.

This device complies with Part 15 of the FCC Rules. Operation is subject to the following two conditions: (1) this device may not cause harmful interference, and (2) this device must accept any interference received, including interference that may cause undesired operation.

Telephone Company Requirements (Part 68 of the FCC Rules)

1. The Telephone Consumer Protection Act of 1991 makes it unlawful for any person to use a computer or other electronic device to send any message via a telephone fax machine unless such message clearly contains in a margin at the top or bottom of each transmitted page or on the first page of the transmission, the date and time it is sent and an identification of the business or other entity, or other individual sending the message and the telephone number of the sending machine or such business, other entity, or individual.

In order to program this information into your computer, you should be sure to follow the installation instructions for your fax software package.

2. The built-in modem is built into the ThinkPad computer. It complies with Part 68 of the FCC Rules. A label is affixed to the bottom of the computer that contains, among other things, the FCC registration number, USOC, and Ringer Equivalency Number (REN) for this equipment. If these numbers are requested, look at the label and provide this information to your telephone company.
3. The REN is useful to determine the quantity of devices you may connect to your telephone line and still have those devices ring when your number is called. In most, but not all, areas, the sum of the RENs of all devices should not exceed five

Warranties and Notices

- (5.0). To be certain of the number of devices you may connect to your line, as determined by the REN, you should call your local telephone company to determine the maximum REN for your calling area.
4. If the built-in modem causes harm to the telephone network, the telephone company may discontinue your service temporarily. If possible, they will notify you in advance. But, if advance notice isn't practical, you will be notified as soon as possible. You will be advised of your right to file a complaint with the FCC.
 5. Your telephone company may make changes in its facilities, equipment, operations, or procedures that could affect the proper operation of your equipment. If they do, you will be given advance notice so as to give you an opportunity to maintain uninterrupted service.
 6. If you experience trouble with this built-in modem, contact your IBM Authorized Seller, or the IBM Corporation, 500 Columbus Avenue, Thornwood, NY 10594, 1-800-772-2227, for repair/warranty information. The telephone company may ask you to disconnect this equipment from the network until the problem has been corrected, or until you are sure the equipment is not malfunctioning.
 7. No customer repairs are possible to the modem. If you experience trouble with this equipment, contact your Authorized Seller or the IBM Corporation for information.
 8. The modem may not be used on coin service provided by the telephone company. Connection to party lines is subject to state tariffs. Contact your state public utility commission or corporation commission for information.
 9. When ordering network interface (NI) service from the Local Exchange Carrier, specify service arrangement USOC RJ11C.
-

Canadian Department of Communications Compliance Statement

This equipment does not exceed Class B limits per radio noise emissions for digital apparatus, set out in the Radio Interference Regulation of the Canadian Department of Communications.

Avis de conformité aux normes du ministère des Communications du Canada

Cet équipement ne dépasse pas les limites de Classe B d'émission de bruits radioélectriques pour les appareils numériques, telles que prescrites par le Règlement sur le brouillage radioélectrique établi par le ministère des Communications du Canada.

European Community Directive Conformance Statement

This product is in conformity with the protection requirements of EC Council Directive 89/336/EEC on the approximation of the laws of the Member States relating to electro-magnetic compatibility.

A declaration of Conformity with the requirements of the Directive has been signed by IBM United Kingdom Limited, PO BOX 30 Spango Valley Greenock Scotland PA160AH.

This product satisfies the Class B limits of EN 55022.

Warranties and Notices

Installation and Operating Instructions Addendum for United Kingdom Users

Users of the IBM ThinkPad 755CX modem function in the United Kingdom (U.K.) must pay close attention to the statements contained in this Addendum.

Modem Connection

1. The modem is suitable for connection to the public switched telephone network (PSTN) provided by British Telecommunications plc or Hull City Telephone Department. (Direct exchange lines only, not shared service or 1-1 carrier systems.)
2. It is suitable for use only on telephone lines provided with Loop-Disconnect or Multi-Frequency Dialling facilities.
3. These modems are only approved for compatible PBX's. IBM should be consulted for an up-to-date list of PBX's with which the modem is compatible.
4. They are suitable for connection to PBX's which return secondary proceed indication.
5. If a modem is to be used with a PBX which returns secondary proceed indication, no more than 2 pauses of four seconds duration each should be inserted between the initial PSTN access digit and the number to be dialled. This is to avoid interference to the BT network.
6. If a modem is to be used with a PBX which has extension wiring owned by BT, connection of the modem to the PBX can only be carried out by BT; or, by the authorized maintainer of the PBX unless the authorized maintainer has been given 14 days written notice that the connection is to be made by another person, and that period of notice has expired.
7. There is no guarantee of correct working in all circumstances. Any difficulties should be referred to IBM.
8. Some network operators require that intended users of their network request permission to connect and for the installation of an appropriate socket.

Ringer Equivalence Number

The ringer equivalence number (REN) of this modem is 1.

REN is a guide to the maximum number of apparatus that can be simultaneously connected to one telephone line. The REN value of each apparatus is added together, and should not exceed 4.

Warranties and Notices

Approved Usage

The modem is approved only for use with the following facilities:

- Storage of telephone numbers for retrieval by a predetermined code
- Detection of initial proceed indication
- Automatic calling
- Tone detection
- Modem
- Operation in the absence of secondary proceed indication

Any other usage will invalidate the approval of your modem, if, as a result, it then ceases to conform to the standards against which approval was granted.

The approval of the modem for connection to UK PSTN is INVALIDATED if the apparatus is subject to modification in any material way not authorized by British Approvals Board Telecommunications (BABT) or if it is used with, or connected to Internal software that has not been formally accepted by BABT.

Installation

The IBM ThinkPad 755CX is manufactured to the International Safety Standard IEC950 and as such is approved in the U.K. under the General Approval number NS/G/1234/J/100003.

The IBM Data/Fax modem installed in the ThinkPad 755CX is approved separately and has its own independent approval number.

This modem, supplied by IBM, does not contain excessive voltages. An excessive voltage is one which exceeds 42.4 v peak ac or 60 v dc. It interfaces with the ThinkPad computer using Safe Extra Low Voltages only. To maintain the independent approval of the IBM adapters, it is essential that other optional cards, not supplied by IBM, do not use main voltages or any other excessive voltages. Seek advice from a competent engineer before installing other adapters not supplied by IBM.

For your continuing safety, care must be taken to ensure that the modem is only used when mounted within the computer with all external covers fastened securely by means of any screws supplied with your installation kit.

Users of this modem are advised that they are only approved for connection to the PSTN via the interface supplied by IBM. Connection of a modem to the PSTN by any other means will invalidate the approval.

General

These modems might not operate satisfactorily on a certain number of trunk routes.

Any persistent difficulties should be referred to IBM.

Warranties and Notices

Storage of Numbers

1. It is advisable to check the telephone numbers stored in your modem immediately after programming, and also after changing the battery in the CPU.
2. To prevent the misdirection of calls and network interference, ensure that all manually programmed telephone numbers are correctly entered.
3. The number you enter to dial might optionally contain a PAUSE character to allow this modem to operate with a PABX. This takes the form:

ACCESS DIGIT + PAUSE CHARACTER + NUMBER TO BE DIALLED

Where the access digit is the number you have to dial to get an outside line, the pause character for this modem is a “,” (comma). The pause character inserts a 4-second delay.

4. This modem can only be used with the DAA P/N 59G1045.

Voice/Telephone Connection

To comply with the British Approvals Board Telecommunications (BABT) requirements the IBM ThinkPad 755CX voice connection application programs must be designed with the following considerations:

Auto-Calling

1. Network addresses

When using the auto-calling to initiate outgoing calls to the PSTN, the user must ensure all manually entered network address are correctly programmed.

Any adjustments which might affect compliance with the U.K. requirements are described in the User and Installation Guide. These adjustments can be made only by authorized personnel.

2. Resolution

The decision-making process for resolution user call progress tones and is internal to ThinkPad 755CX. The user selects the appropriate modes of operation for using the feature.

3. Repeat attempts

The IBM ThinkPad 755CX can determine when to initiate a new call attempt to a number over the PSTN after an ineffective attempt to the same number. This is called repeat attempt feature.

The number of repeat call attempts and the minimum durations between these repeat attempts must follow one of the call patterns specified in the following table.

Warranties and Notices

Repeat Attempts: Number of Attempts and Durations between Attempts

Call attempt	Minimum Duration between Call Attempts for Call Pattern		
	A	B	C
Initial attempt			
1st repeat attempt	5 seconds	5 seconds	5 seconds
2nd repeat attempt	1 minute	2 minutes	10 minutes
3rd repeat attempt	1 minute	2 minutes	10 minutes
4th repeat attempt	1 minute	2 minutes	10 minutes
5th repeat attempt	End of sequence (See note 1)	2 minutes	10 minutes
6th repeat attempt		2 minutes	10 minutes
7th repeat attempt		End of sequence (See note 1)	10 minutes
<i>n</i> th repeat attempt (See note 2)			10 minutes

Notes:

1. The maximum number of calls for repeat attempt pattern A is 5, and for call pattern B is 7.
2. No limit is specified for the value of *n*.
3. The durations given in this table are measured from clear-down to re-seizure.

Glossary

This glossary includes terms and definitions from the *IBM Dictionary of Computing* (New York: McGraw-Hill, 1994).

ac. Alternating current.

ac power. Power that is supplied to the computer through an electrical outlet.

ANSI. American National Standards Institute.

application program. A program that performs specific tasks on your computer, such as word processing or creating spreadsheets.

Advanced Power Management (APM). A facility consisting of one or more layers of software that support power management in computers with power manageable hardware. The APM software interface allows applications, operating systems, device drivers, and the APM BIOS to work together to reduce power consumption, without reducing system performance.

ASCII. American National Standard Code for Information Interchange.

ATA PC Card. A PC Card with an AT attachment hard disk drive interface such as a storage device PC Card.

AUTOEXEC.BAT. A file that contains a startup procedure of DOS. Each time you start your system, DOS performs the commands that are stored in this file.

backup copy. A copy, usually of a file or group of files, that is kept in case the original file or files are unintentionally changed or destroyed.

batch. A process method in which a program or programs records with little or no operator action.

BIOS (Basic Input/Output System). Microcode that contains such basic hardware operations as interactions with diskette drives, hard disk drives, and the keyboard.

bitmap graphics. (1) A form of graphics in which all points on the display are directly addressable. (2) In multimedia

applications, a form of graphics in an area of computer memory or storage that can be displayed as an image.

boot. To prepare a computer system for operation by loading an operating system.

bps. Bits per second. In serial transmission, the instantaneous bit speed with which a device or channel transmits a character.

bus. A facility for transferring data between several devices located between two end points, only one device being able to transmit at a given moment.

cache memory. A special memory, smaller and faster than main memory, that is used to hold a copy of instructions and data in main memory that are likely to be needed next by the processor, and that have been obtained automatically from main memory.

combination keys. Keys that have specific functions when you hold them down at the same time.

configuration. (1) The manner in which the hardware and software of an information processing system are organized and interconnected. (2) The physical and logical arrangement of devices and programs that make up a data processing system. (3) The devices and programs that make up a system, subsystem, or network.

CONFIG.SYS. A file that contains a group of commands to load installable device drivers and reserve space in system memory for information processing. This file is referred to by DOS during system startup.

CRT. Cathode ray tube display.

device driver. A file that contains the code needed to attach and use a device. Operating system loads device drivers for screens, keyboards, printers, diskette drives, hard disk drives, and auxiliary devices. The user can replace these or add other devices by coding and loading a device driver.

DIMM. Dual inline memory module.

Glossary

directory. A type of file containing the names and controlling information for other files or other directories.

DMA. Direct memory access. The transfer of data between memory and input/output units without processor intervention.

double-click. To press and release a mouse button twice within a time frame defined by the user, without moving the pointer off the choice.

DRAM. Dynamic random access memory.

DSP. Digital signal processor.

DSTN. Dual-scan supertwisted nematic.

EGA. Enhanced graphics adapter.

EIA. Electronics Industries Association.

EIA-232D. An EIA interface standard that defines the physical, electronic, and functional characteristics of an interface line that connects a communication device and associated workstation. It uses a 25-pin connector and an unbalanced line voltage.

EMS. Expanded memory specification.

fax. (1) Facsimile machine. (2) A transmitted document from a facsimile machine.

fixed disk. In personal computing, *fixed disk* is synonymous with *hard disk*.

flash memory. Electrically rewritable storage.

folder. A file used to store and organize documents.

fuel gauge. An indicator on the screen that constantly shows the current power status of the battery pack.

hibernation. One of the power-saving methods that stores data and applications running in the computer's memory on the hard disk. During hibernation, the computer is automatically turned off to save power. When power is turned on again, the computer

immediately restores the same data and applications as when hibernation started, without restarting the operating system.

high-performance mode. A method of increasing the access time of video memories for dual-scan STN LCDs, to produce high-quality video on an external display (CRT).

high-resolution mode. Video resolutions that are greater than 640 by 480 pels.

icon. A graphic symbol, displayed on a screen, that a user can point to with a pointing device such as a TrackPoint III or mouse to select a particular function or software application.

IR. Infrared.

ISA. Industry standard architecture.

ISO. International Organization for Standardization.

JEIDA. Japan Electronics Industry Development Association.

kilobyte (KB). 1024 bytes.

LAN. Local area network.

megabyte (MB). 1024 kilobytes. About 1 million bytes.

memory. Often referred to as random-access memory (RAM), measured in kilobytes (KB) or megabytes (MB) of information.

MHz. Megahertz.

microcode. One or more microinstructions used in a product as an alternative to hard-wired circuitry to implement functions of a processor or other system component.

MIDI. Musical Instrument Digital Interface.

modem. A device that connects your computer to a telephone line, allowing it to communicate with another computer at another location.

parallel port. A port used to attach such devices as dot-matrix printers and

input/output units; it transmits data 1 byte at a time.

partial suspend mode. A kind of suspend mode where only a part of the system components uses power.

password. A series of letters or numbers that you designate to restrict access to your computer.

PC Card. A card that is based on the PCMCIA standard.

PCMCIA. Personal Computer Memory Card International Association.

pel. Picture element.

picture element. In computer graphics, the smallest element of a display surface that can be independently assigned color and intensity.

pixel. Picture element.

pointing device. An instrument, such as a mouse, TrackPoint III, or joystick, that is used to move a pointer on the screen.

POST. Power-on self-test.

pop-up menu. On the display screen, a menu that emerges in an upward direction from a particular point or line on a display screen.

prompt. A visual or audible message sent by a program to request the user's response.

pull-down menu. On the display screen, a menu that emerges in a downward direction from a point or line at or near the top of the screen.

reboot. Restart all operations of the computer as if the power were just turned on.

resume. To begin computer operations again from suspend mode.

ROM. Read-only memory.

serial port. A port used to attach such devices as display devices, letter-quality printers, modems, plotters, and such pointing devices as light pens and mice; it transmits data 1 bit at a time.

suspend. Stops all operations of the computer to reduce power drain and restrict access to the files.

SVGA. Super video graphics adapter, a video mode that produces up to 1024-by-768 resolution.

STN. Supertwisted nematic.

TFT. Thin film transistor.

TSRs. Terminate-and-stay-resident programs, memory-resident programs that are loaded into memory and stay there so you can conveniently access them whenever you need to.

vertical expansion. A video display technique in character-display mode to fit video images on the whole LCD screen by adjusting the number of character dots vertically.

VESA. Video Electronics Standards Association.

VGA. Video graphics adapter, a video mode that produces up to 640-by-480 resolution.

XMS. Extended memory specification.

A

- AC Adapter 18
 - cable, wrapping 19
 - connecting 8
 - voltage 18
- answering machine 90
- APM (Advanced Power Management) 104
 - installing for Windows 177
- AT bus 250
- attaching
 - Dock I or II 172
 - expansion unit 172
 - external display 165
 - external keyboard 163
 - external numeric keypad 159
 - mouse 159
 - printer 164
- audio features 75
 - additional information 243
 - problems 213
 - using 78
- Auto Configurator 231
- automatic, power mode 37

B

- battery charging status indicator 16
- battery pack 20
 - charging 92, 93
 - charging, indicator 16
 - discharging
 - canceling, for DOS 102
 - canceling, for OS/2 and Windows 100
 - for DOS 102
 - for OS/2 and Windows 100
 - disposing ix
 - fuel-gauge program, using 98
 - installing 6
 - location 15
 - low-battery condition 97
 - maximizing battery power 104
 - monitoring battery power 96
 - battery power status indicator, using 96
 - fuel-gauge program, using 98
 - operating time 20, 92
 - preserving battery-pack life 103
 - problems 211
 - replacing 95

- battery pack (*continued*)
 - storage switch 21
- battery power status indicator 16, 96
- bidirectional, parallel 43
- boot diskette 79
- boot, selectable 47
- brightness control
 - location and function 13
- broken keylock 210
- bus, system 249

C

- Caps Lock indicator 17
- car battery adapter 22
- carrying the computer 31
- changing password
 - hard-disk password 116
 - power-on password 112
 - supervisor password 120
- charging, battery pack 92
 - with AC Adapter 93
 - with travel quick charger 94
- click buttons (TrackPoint III)
 - location 13
 - using 23
- Config menu
 - Easy-Setup 43
- CONFIG.SYS
 - example for PC Cards 236
 - updating for PC Cards 238
- connector door
 - location 15
- CPU
 - See microprocessor
- customized, power mode 37

D

- date and time
 - Easy-Setup 44
 - prompt 34
- device driver
 - Auto Configurator, using 231
 - installing
 - display driver 188
 - infrared support software 196
 - Mwave support software 192
 - PCMCIA device driver 183
 - ThinkPad Features program 180
- DIMM adapter 137
- discriminator 88
- diskette drive

- diskette drive (*continued*)
 - bezel
 - installing 154
 - removing 150
 - in use, indicator 16
 - installing other options 150
 - location 15
 - problems 213
 - removing 138
- diskette standards 254
- diskette-eject button
 - location and function 15
- display 27
 - device driver, installing 188
 - LCD
 - switching to 48
 - problem 27
 - switching, using Fn key 48
 - using 27
- display driver
 - installing, for OS/2 189
 - installing, for Windows 191
- DMA channel 227
- Dock I or II
 - attaching 172
 - speaker volume control, using Fn key 49
- docking control utility 40
- DOS Version 7.0 or later
 - installing 176
- drive-startup sequence 47
- DSP 75

E

- Easy-Setup
 - Config menu 43
 - date and time menu 44
 - main menu 42
 - password menu 44
 - restart menu 46
 - start up menu 45
 - test menu 45
 - using 42
- EMS, specifying software 235
- error codes 208
- expansion unit
 - attaching 172
 - speaker volume control, using Fn key 49
- external devices
 - Dock I or II 172

- external devices (*continued*)
 - external display 165
 - external keyboard 163
 - external numeric keypad 159
 - external unit 172
 - modem/fax port 155
 - mouse 159
 - printer 164
- external display
 - attaching 165
 - color depth, changing 170
 - connector 5, 15
 - display driver, setting 167
 - problem 27
 - screen resolution, changing 170
 - using 27
- external input device connector
 - location and function 13
- external keyboard 5
 - attaching 163
- external numeric keypad 5
 - attaching 159

F

- fax 89
- features 249
- Fn key
 - function 48
 - location 13
- fuel-gauge program 98
 - Fn key function, using 48
 - monitoring battery status 99, 101

G

- game support 75

H

- hard disk drive
 - indicator, in use 16
 - locking lever 130
 - replacing 148
 - securing, with chain 130
 - securing, with password 114
 - several hard disk drives, using 123
- hard-disk password
 - changing 116
 - prompt 34
 - removing 117

- hard-disk password (*continued*)
 - setting 115
 - using 114
 - with power-on password 122
 - with supervisor password 122
 - wrong hard-disk password, entering 114
- hardware conflicts 227
- hardware specifications 251
- headphone jack 5, 15
- heat output, machine specifications 251
- HelpClub 224
- Helpware 224
- hibernation file, creating 59
- hibernation mode
 - creating hibernation file 59
 - using 57
 - using Fn key function 49
- high performance, power mode 37
- humidity, machine specifications 251

I

- I/O address 227
- IC DRAM card 137
- identification numbers, recording 222
- indicator panel 13, 16
- infrared communication 72
- Infrared Features Diskette 3
- infrared port 5
 - location and function 13, 15
 - problems 214
- initialize
 - Easy-Setup 43
- input voltage 251
- installing
 - device drivers 180—197
 - DIMM 138
 - diskette drive bezel 154
 - hard disk drive 148
 - IC DRAM card 138
 - modem/fax port 155
 - operating systems 176
 - option cover 153
 - PC Card 134
- intermittent problems 220
- internal devices
 - in diskette drive compartment 150
 - securing 130
- interrupt level (IRQ) 227
- IR (infrared) communication 72
- IRQ 227

K

- Kensington lock
 - keyhole 5, 13
 - using 131
- keyboard
 - Easy-Setup 43
 - location 13
 - machine specifications 249
 - securing, from opening 130
 - template 3
- keyboard/mouse connector 163

L

- LCD
 - location and function 13
 - problems 27, 204
- legs
 - location and function 15
- lithium ion battery pack 20
- locations and functions 12—15
- lock
 - hard disk drive lock 130
 - Kensington lock 131
 - PC Card lock 132
- locking lever
 - location and function 15
 - using 130
- low-battery condition 97

M

- maximizing battery power
 - decreasing LCD brightness 105
 - using advanced power management 104
 - using power-saving options 107
- memory
 - address 227
 - Easy-Setup 43
 - increasing capacity 137
 - machine specifications 249
 - slot 5
 - location and function 15
- memory module (DIMM) 137
- messages on screen 206
- microphone (built-in)
 - location and function 13
- microphone/line-in jack 5
 - location and function 15
- microprocessor

microprocessor (*continued*)
 machine specifications 249
 speed 37

MIDI

 overview 244
 support 75
modem 84
 PC Card
 installing 134
 removing 136
 problems 213
modem/fax port 5
 installing 155
 location and function 15
 release latch
 location and function 15
mouse 5
 attaching 159
 using with
 Space Saver Keyboard 161
 TrackPoint III 159
Mwave DSP Features Diskettes 3
Mwave DSP function
 additional information 243
 answering machine 90
 audio 78
 discriminator 88
 fax modem 89
 MIDI mapper 244
 MIDI synthesizer 244
 modem 84
 problems 213
 telephony 84
 using 75
Mwave support software
 installing, for DOS 194
 installing, for OS/2 192
 installing, for Windows 195

N

nickel metal hydride battery pack 21
numeric keypad 26
numeric lock indicator 17

O

online book 29
operating systems, installing
 DOS 176
 OS/2 176
 Windows 177
option cover

option cover (*continued*)
 installing 153
 location and function 15
 removing 150

options

 DIMM 137
 installing 138
 removing 143
 diskette drive
 problems 213
 removing 138
 Dock I or II
 attaching 172
 expansion unit
 attaching 172
 external display
 attaching 165
 problems 218
 external keyboard, attaching 163
 external numeric keypad
 attaching 159
 problems 216
 hard disk drive, replacing 148
 IC DRAM card 137
 in diskette drive compartment 150
 keyboard
 problems 216
 modem/fax port
 installing 155
 mouse
 attaching 159
 PC Card
 inserting 134
 removing 136
 using 61
 pointing device
 problems 216
 printer
 attaching 164
 problems 220
 problems 215
OS/2
 installing 176

P

parallel
 Easy-Setup 43
parallel connector 5
 location and function 15
part numbers, power cords 252
password 44

- password (*continued*)
 - Easy-Setup 44
 - hard-disk password
 - changing 116
 - power-on password, using
 - with 122
 - removing 117
 - setting 115
 - using 114
 - wrong, entering 114
 - personalization utility, using with 125
 - power-on password
 - changing 112
 - hard-disk password, using
 - with 122
 - removing 113
 - setting 111
 - using 110
 - wrong, entering 110
 - supervisor password
 - changing 120
 - hard-disk password, using
 - with 122
 - removing 121
 - setting 119
 - several hard disk drives,
 - using 123
 - using 118
 - wrong, entering 118
- PC Card
 - advanced use of 231
 - device driver, installing 183
 - Director 62
 - eject button 13
 - example of CONFIG.SYS file 236
 - indicator, active 16
 - installing 134
 - releasing its memory area 240
 - removing 136
 - securing 132
 - slot 13
 - software considerations
 - DOS 235
 - necessary software 183
 - OS/2 234
 - under suspend and hibernation
 - mode 61
 - Windows 242
 - software EMS, specifying 235
 - suspend mode, using with 55
 - updating CONFIG.SYS file 238
 - using 61
- PC Card Director (*continued*)
 - installing, for DOS 186
 - installing, for OS/2 185
 - installing, for Windows 187
 - using 62
- PCMCIA card
 - See PC Card
- PCMCIA device driver
 - installing, for DOS 186
 - installing, for OS/2 185
 - installing, for Windows 187
- PCMCIA Features Diskette 3
- PCMCIA slot 5
 - location and function 13
- personalization utility 125
- pointing device 159
- power cord 3
- power cords 252
- power jack
 - location 15
- power management function
 - using 50
- power mode
 - automatic 50
 - customized 50
 - high performance 50
 - switching, using Fn key 49
- power shutdown switch
 - location and function 15
- power switch
 - location and function 15
- power-on indicator 17
- power-on password
 - changing 112
 - hard-disk password, using with 122
 - prompt 34
 - removing 113
 - setting 111
 - using 110
 - wrong power-on password,
 - entering 110
- preserving battery-pack life 103
- printer
 - attaching 164
- problems
 - battery pack 211
 - common 200
 - diskette drive 213
 - error codes 208
 - external display 28, 218
 - external numeric keypad 216
 - general 210
 - infrared communication 214

- problems (*continued*)
 - intermittent 220
 - keyboard 216
 - LCD 28, 204
 - messages on screen 206
 - modem 213
 - Mwave DSP function 213
 - options 215
 - pointing device 216
 - printer 220
 - software 215
 - test cannot find problem 211
 - testing the computer 202
 - TrackPoint III 216
 - troubleshooting charts 204
- processor
 - See microprocessor
- product map 2
- ps2
 - mode3x command 205
 - program 41
- ps2 mode3x command 219

Q

- quick charger 92

R

- rear door
 - location 15
- record of identification numbers 222
- release latches
 - location and function 13
- removable
 - diskette drive
 - location 15
 - hard disk drive
 - location 15
- removing
 - battery pack 95
 - bezel 150
 - DIMM 143
 - diskette drive 138
 - hard disk drive 148
 - hard-disk password 117
 - IC DRAM card 143
 - modem/fax port 155
 - option cover 150
 - PC Card 136
 - PC Card lock 132
 - power-on password 113

- removing (*continued*)
 - supervisor password 121
- repair services
 - getting service 223
 - HelpClub 224
 - identification numbers 222
- resource map utility 229
- restart menu
 - Easy-Setup 46
- resume function 50
- RPL (remote program load) 47

S

- safe suspend 54
- screen messages
 - date and time prompt 34
 - F1 and diskette prompts 34
 - hard-disk password prompt 34
 - power-on password prompt 34
 - power-on self test (POST) error 34
- scroll lock indicator 17
- security
 - hard disk drive, with chain 130
 - internal devices 130
 - Kensington lock 131
 - keyboard, from opening 130
 - keyhole 5
 - password, security with
 - hard-disk password 114
 - power-on password 110
 - supervisor password 118
 - PC Card 132
 - personalization utility 125
- serial
 - connector 5
 - location and function 15
 - Easy-Setup 43
 - number 222
- service
 - HelpClub 224
 - how to get 223
 - installed options 221
- setting password
 - hard-disk password 115
 - power-on password 111
 - supervisor password 119
- size, machine specifications 251
- software
 - CONFIG.SYS, example for PC Cards 236
 - CONFIG.SYS, updating for PC Cards 238

- software (*continued*)
 - EMS, specifying 235
 - problems 215
 - Sound Blaster support 75
 - speaker (built-in)
 - location and function
 - speaker indicator 16
 - specifications
 - battery pack 251
 - heat output 251
 - humidity, environment 251
 - input voltage 251
 - size 251
 - temperature, environment 251
 - weight 251
 - standards, diskette 254
 - standby mode
 - Fn key function, using 48
 - using 52
 - start up menu
 - Easy-Setup 45
 - start up, changing 47
 - starting the computer 34
 - sticky Fn key 48
 - storage switch 21
 - storage, machine specifications 249
 - supervisor password
 - changing 120
 - hard-disk password, using with 122
 - removing 121
 - setting 119
 - several hard disk drives, using 123
 - using 118
 - wrong, entering 118
 - suspend mode
 - Fn key function, using 48
 - PC Card, using with 55
 - software considerations 55
 - using 53
 - suspend mode indicator 17
 - SVGA
 - display driver, installing 188
 - setting 165
 - system bus, machine specifications 249
 - system expansion connector 5
 - location and function 15
 - system-status indicators 16
 - battery charging status 16
 - battery power status 16
 - caps lock 17
 - diskette drive in use 16
 - hard disk in use 16
 - numeric lock 17
 - system-status indicators (*continued*)
 - PC Card active 16
 - power on 17
 - scroll lock 17
 - speaker 16
 - suspend mode 17
 - systemboard
 - Easy-Setup 43
- T**
- telephony features 75
 - using 84
 - temperature, machine
 - specifications 251
 - test menu
 - Easy-Setup 45
 - testing the computer 202
 - ThinkPad Features program
 - alarm menu 38
 - display menu 38
 - docking control utility 40
 - fuel-gauge program 40
 - installing
 - DOS 181
 - OS/2 180
 - Windows 182
 - main menu 35
 - personalization utility 40
 - power menu 37
 - setup menu 39
 - suspend, hibernation, and resume
 - option 37
 - using
 - for DOS 41
 - for OS/2 and Windows 36
 - ThinkPad setup menu 39
 - TrackPoint III
 - cleaning 25
 - location 13
 - using 23
 - travel quick charger 92
 - troubleshooting charts 204—220
 - typematic 43
- U**
- unidirectional, parallel 43
 - Utility Diskette 3

V

- video device driver
 - See display driver
- Video Features Diskette 3
- virtual screen 38
- volume control
 - location and function 13

W

- warranties and notices, product 255
- weight, machine specifications 251
- Windows Version 3.11 or later
 - installing 177