

C.H.I.P. Pro Carrier Board - SMT Solder Footprint

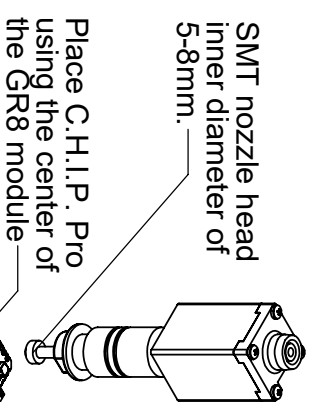

EXPLODED ISO VIEW
SMT NOZZLE PLACEMENT
SCALE 1:2

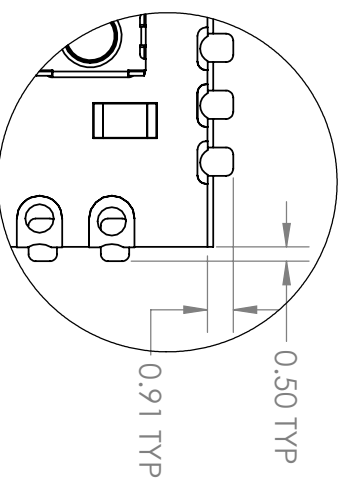
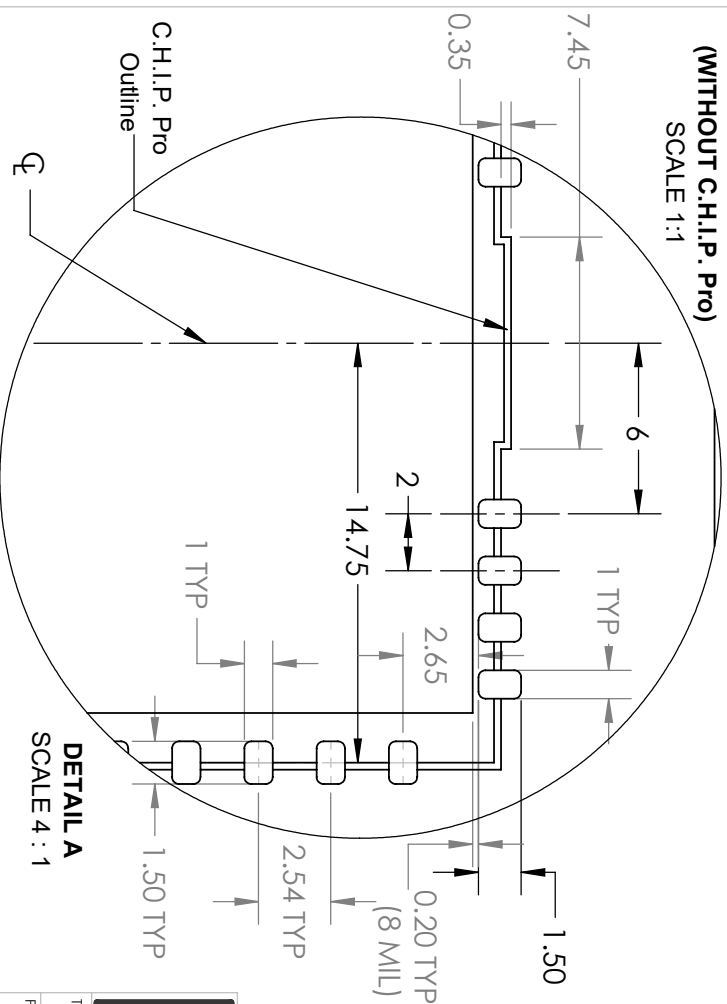
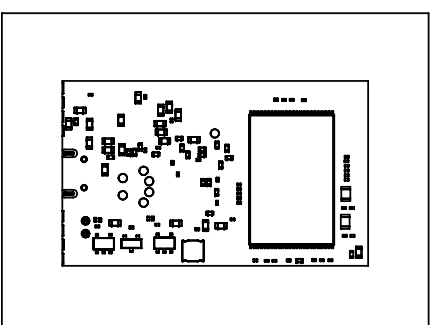
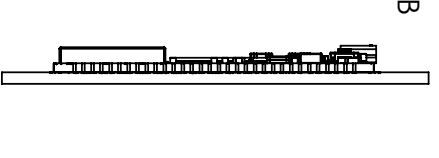
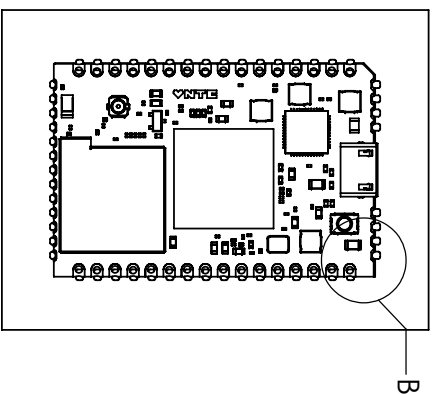
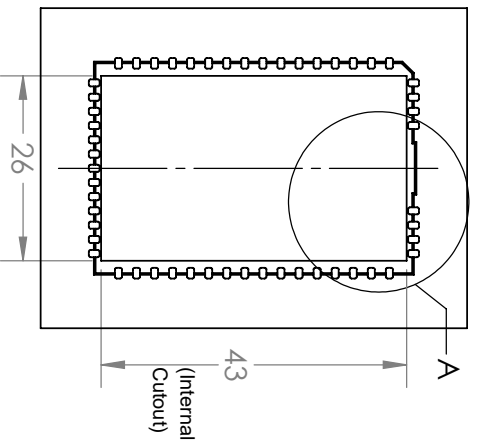

TITLE: C.H.I.P. Pro Carrier PCB Footprint		SHEET 1 OF 3		MATERIAL: N/A	
PART NO: N/A	DATE: 6/6/2017	REVISION: V1.0	UNITS: mm	FINISH: N/A	PHONE NO:
CONTACT:			TOLERANCE: +/- 0.1 mm	COLOR: N/A	
EMAIL: pro@nextthing.co					